



SURGICAL INSTRUMENTS



sales@wellcaresurgicals.co.uk
www.wellcaresurgicals.co.uk



**SURGICAL
INSTRUMENTS
CATALOGUE**



9001:2003 13485:2008

About us:

Wellcare Surgicals is a privately owned company dedicated to innovation and excellence in the crafting of surgical instruments. The company started as a specialist in reconstructive surgery instruments and based on its success and innovative drive gradually expanded to cover a vast range of surgical instruments. Since its inception, Wellcare has continually expanded throughout *United Kingdom, Europe & rest of the world* to provide a wide range of surgical & dental instruments both reusable & disposable. All our products are professionally supported by qualified Product Managers and specialists, trained to work in surgical and operating room environments.

Manufacturing:

At our manufacturing Unit, qualified technicians have been producing a wide range of instruments for use in many areas of surgery. Our innovative approach combined with years of experience has resulted in an expansion of scope encompassing new technical advancements within the Healthcare industry. We have been hand making Surgical Instruments for decades and have a wealth of manufacturing expertise at your disposal. As we manufacture everything in-house we are able to accommodate unusual requests, and can produce bespoke instruments if our customers prefer something 'made to measure'. This flexibility allows us to meet the increasing demands of the modern theatre environment.

Our continued commitment to quality has ensured that our products are manufactured to the highest standard having been assessed and registered as meeting the requirements of **ISO 9001-2008, ISO13485-2003** and European **Medical Devices Directive (93/42/EEC)**

Our management system ensures a consistent quality product is supplied first time, every time.

Reliability:

All our instruments carry a Five Year Guarantee, meaning you can buy with confidence. Our instruments can last a lifetime if they are used and maintained with care, ensuring replacement costs are minimal.

Price:

By dealing directly with the manufacturer you are able to benefit from significant cost savings, an important factor when trying to get the most out of your budget.

Our Aim:

To provide hospitals, surgeons and medical practitioners with surgical instruments of the highest quality, precision and cost-effectiveness.

To develop **Wellcare Surgicals** reputation as a world class manufacturer of high quality surgical instruments.

To establish Wellcare Surgical as the preferred host for surgeons across the globe for multi-discipline R&D in partnership with and for surgical instrument industry.

Instruments Cleaning Procedure

Enemies of Surgical Instruments:

Water and moisture of any kind (especially blood, pus, surgical debris and chlorhexidine solutions)
Cold soaking or washing instruments with inappropriate solutions such as dish or laundry soap, bleach, iodine-type solutions, general disinfectants, surgeon's hand scrub
Allowing any type of moisture to air-dry on your instruments will cause severe damage

Causes of Corrosion Staining, Pitting and Marking:

Surgical residues such as blood, pus and other secretions contain chloride ions which lead to corrosion most often appearing as dark spots.
Blood is left on the instruments for any period of time (20 minutes or longer)
Residues are allowed to dry causes pitting.
The most damaging procedure is to allow dried-on blood to become baked-on stains in the autoclave.
The temperature of the autoclave (250°270°F or 121°132°C) will cause chemical reactions that can make the stain permanent.
The cleansers and cleaning agents you use could also be a source of corrosion.
Strong substances, as well as those containing a chemical make-up of acid or alkaline-based solutions, can lead to pitting and staining.
Wash instruments with a neutral pH soap (between 7pH - 8pH) that is designed for surgical instruments for optimal results. Anything with a higher pH may damage the instrument.
Use of dish soap, iodine, bleach, cold-soak solution, chlorhexidine-based solutions, laundry soap or surgeons hand scrub will cause spotting and corrosion.

Cleaning After Surgery:

The washing process should begin within 20 minutes after surgery
It prevents blood from drying and is your best defense against corrosion, pitting and staining.
Only use approved solutions for washing, disinfecting, and lubricating.
Approved solutions are specifically designed for surgical instruments and the sterilization cycle. Their product labels will state this use.

Sterilization:

All surgical instruments must be sterilized prior to surgery to prevent infection.
Only sterilize a clean instrument.
Even sterilization can leave contaminants behind if not properly cleaned.
Sterilize instruments with the ratchets open.
This allows for better steam penetration. Plus, it prevents the box locks (hinge area) from cracking.
If using a pan or tray, we recommend one with perforations. This will also enable better steam penetration and aids in more effective drying as well.
Place heavy instruments at the bottom and lighter, more delicate instruments on top.
If sterilizing in paper or plastic pouches, do not stack pouches on top of one another during sterilization.

Ultrasonic Cleaning:

Ultrasonic cleaning is 16 times more efficient than manual cleaning alone. Place instruments in the ultrasonic unit for 10-15 minutes and use a neutral pH ultrasonic solution. Here are a few tips for ultrasonic cleaning:

Before placing into the ultrasonic unit, clean instruments of all visible debris by hand-washing them in neutral pH soap. Before placing instruments into the ultrasonic unit, turn on the ultrasonic machine and let it run for 10 minutes to de-gas the solution. This process removes any gas or air bubbles in the solution.

The cleaner the instruments go into the ultrasonic cleaner, the cleaner they will come out.

As with all types of cleaning, open all instruments so ratchets and box locks are fully exposed to the cleaning process.

Make sure instruments have plenty of room. Don't overload your ultrasonic cleaner.

Do not mix dissimilar metals (such as aluminum and stainless) in the same cycle to prevent cross-plating.

Upon completion of the cycle, remove instruments immediately and rinse them.

Dry instruments thoroughly with a towel, ensuring that no moisture is left on the instruments.

Lubrication:

One of the easiest, yet most effective ways to keep instruments in excellent condition is to lubricate them after every cleaning. Proper lubrication keeps the moving parts of instruments from rubbing and scraping, thus preventing dulling and strain to joints and hinges. Moving parts on instruments, such as joints, box locks, ratchets, and screw joints, should be lubricated regularly. Before autoclaving, lubricate all instruments that have moving parts. Only use water-based surgical lubricants because they are steam penetrable.



Tip Protectors:

The use of tip protectors is a good practice that protects valuable instruments and scopes from damage. Many times the damage to an instrument from not using tip protectors is not repairable, making it necessary to replace the instrument. Tip protectors can be used on the tips of pointed scissors and sharp instruments, skin hooks, distal tips of rigid scopes and to guard the cutting edges of osteotomes.



Table Of Contents













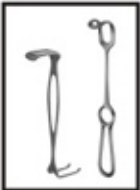

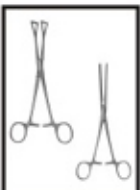
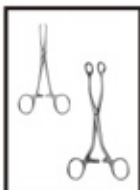
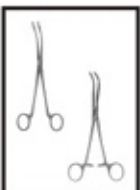
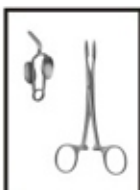
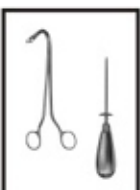
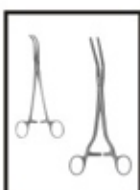

Diagnostic, Anaesthesia and other instruments	Page Seite 1 - 10		Probes, Pocket Instruments sets	Page Seite 66 - 68	
Scalpels, knives and Scalpel Handles	11 - 14		Wound Retractors	69 - 80	
Scissors	15 - 31		Self-Retaining Retractors, Abdominal Retractors	81 - 85	
Dissecting-and Tissue Forceps	32 - 42		Abdominal Surgery Intestinal-and Rectal Instruments	86 - 93	
Sponge, Dressing and Tissue Grasping Forceps Towel Clamps	43 - 48		Gall Bladder-, Liver-and Spleen Instruments	94 - 96	
Vessel Clips, Bulldog Clamps Haemostatic Forceps	49 - 57		Genito-Urinary Instruments and Trocars	97 - 100	
Ligature, Hysterectomy and Compression Forceps Vaginal Clamps	58 - 60		Vaginal Specula and Uterine Dilators	101 - 106	
Needle Holders, Suture Instruments	61 - 65		Uterine Probes, Uterine Dressing-, Polypus-and Ovum Forceps	107 - 109	

Table Of Contents

	Page Seite		Page Seite	
Biopsy Instruments and Curettes	110 - 116		Suction Instruments	158 - 166
Obstetrics and Tracheotomy	117 - 119			
Cardiovascular-and Thoracic Surgery	120 - 128			
Bone Punches, Rongeurs	129 - 134			
Elevators, Bone Levers, Raspatories, Bone Files, Bone Curettes	135 - 139			
Mallets, Chisels and Gouges	140 - 141			
Bone Holding Forceps, Bone Rongeurs, Bone Cutting Forceps	142 - 146			
Plaster Instruments	147 - 157			

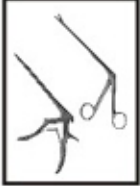
Percussion Hammers and Aesthesiometers



01-101
TROEMNER
Size: 245 mm



01-102
DEJERINE
Size: 200 mm



01-103
DEJERINE
with needle
Size: 210 mm



01-104
TAYLOR
Size: 195 mm



01-105
BERLINER
Size: 200 mm

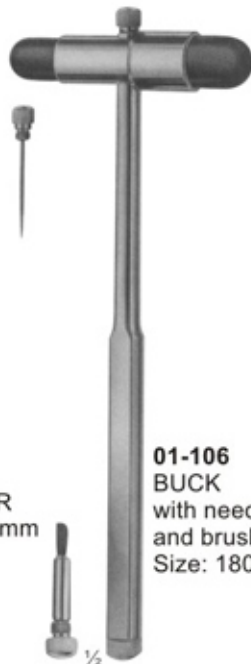

01-106
BUCK
with needle
and brush
Size: 180 mm



01-107
RABINER
with needle
and brush
Size: 255 mm



01-108
ALY
Size: 190 mm



01-109
WARTENBERG
Pinwheel for
neurological
examination
Size: 185 mm

Stethoscopes



01-110
PINARD (Aluminum)
Size: 155 mm

½



01-111
wooden
Size: 145 mm

½



01-112
BOWLES
Stethoscope
with diaphragm

¼



01-113
ANESTOPHON

½



01-114
FORD-BOWLES
Dual chest piece
with two outlets

¼



01-115
BOWLES

¼

Head Mirrors and Head Bands



01-116
ZIEGLER Ø 90mm
head mirror only
with rubber coating

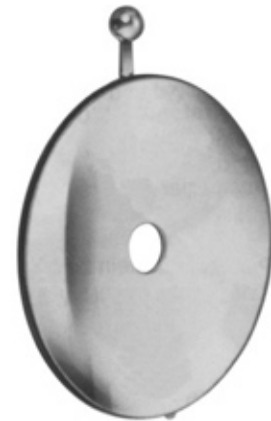

01-117
ZIEGLER Ø 90mm
head mirror only
with metal coating



01-118
ZIEGLER
head band of plastic black

01-119
ZIEGLER
head band of plastic white

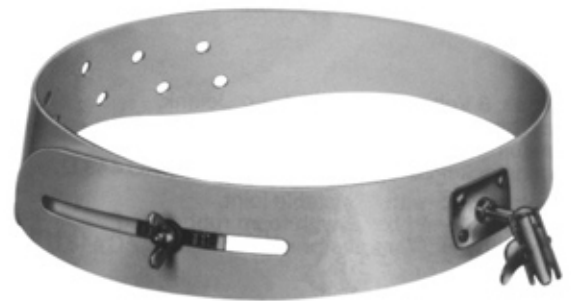

01-120
MURPHY
head band of celluloid, white

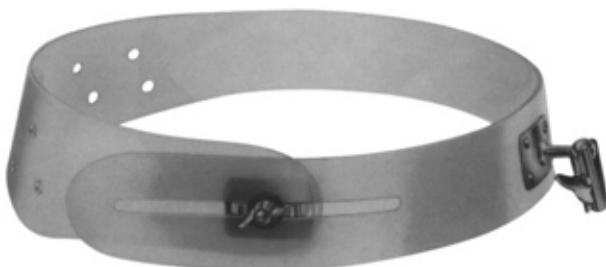

01-121
head band of plastic,
white, soft pattern



01-122
head mirror with black
plastic head band.

Tongue Depressors

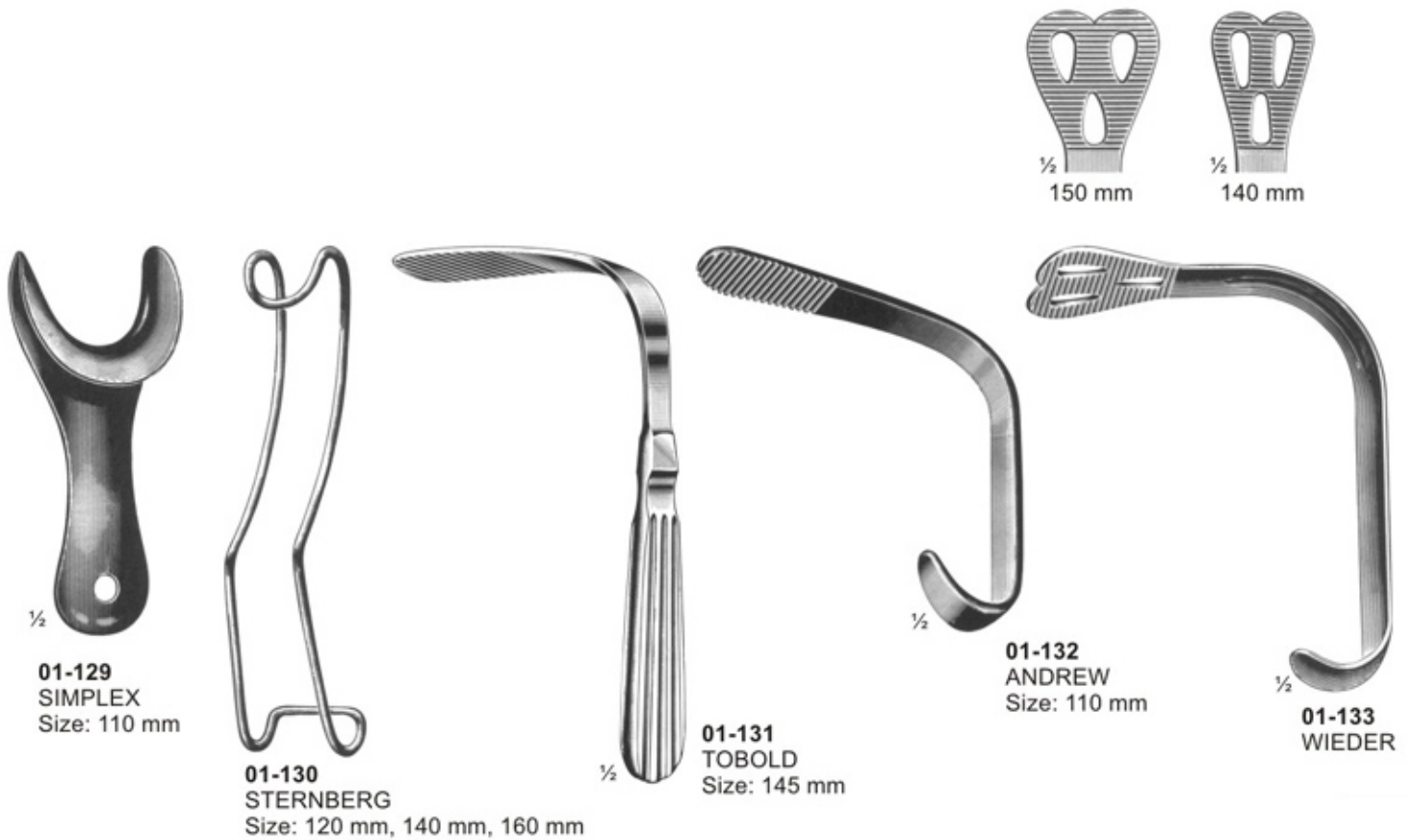
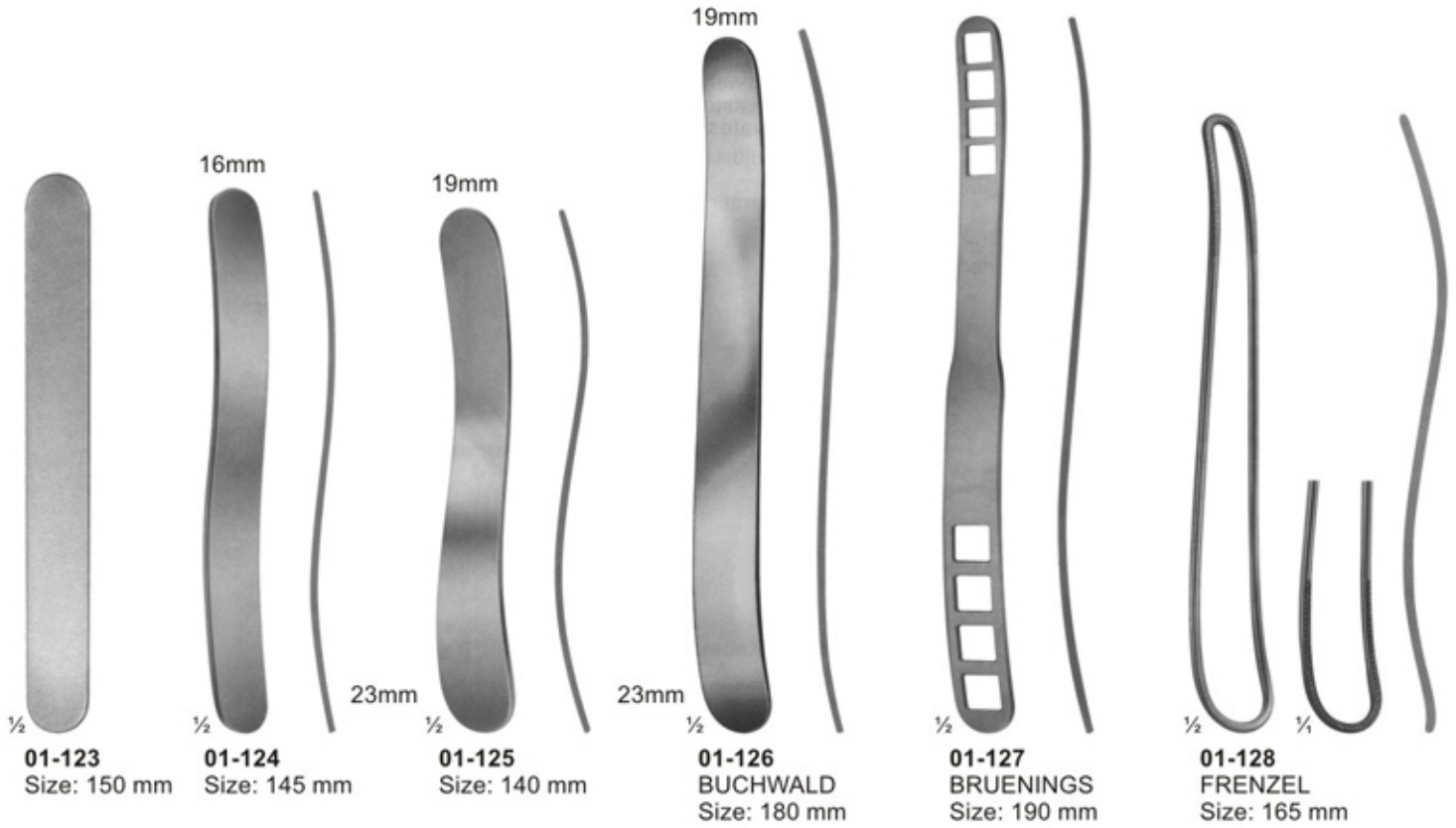

Instruments for Anaesthesia and Tongue Forceps



1/2
01-134
SCHIMMELBUSCH
Ether mask



1/2
01-135
HEISTER
Mouth gag
Size: 130 mm



1/2
01-136
FERGUSSON-ACKLAND
Mouth gag
Size: 145 mm



1/2
01-137
DENHARDT
Mouth gag with silicon
inserts, interchangeable
Size: 125 mm



1/2
01-138
ROSER KOENIG
Mouth gag
Size: 160 mm, 185 mm

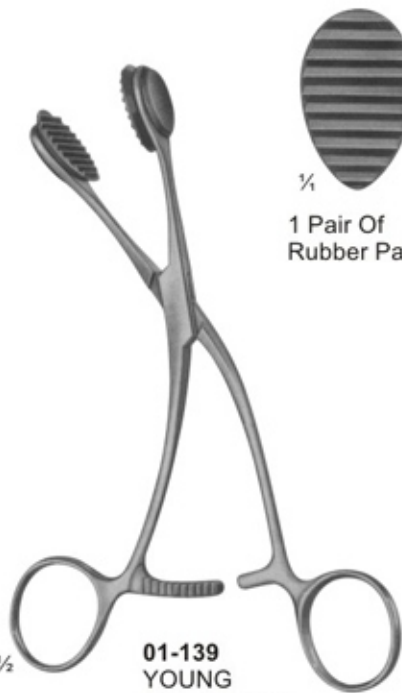

1/2
01-139
YOUNG
Size: 165 mm



1/4
1 Pair Of
Rubber Pads

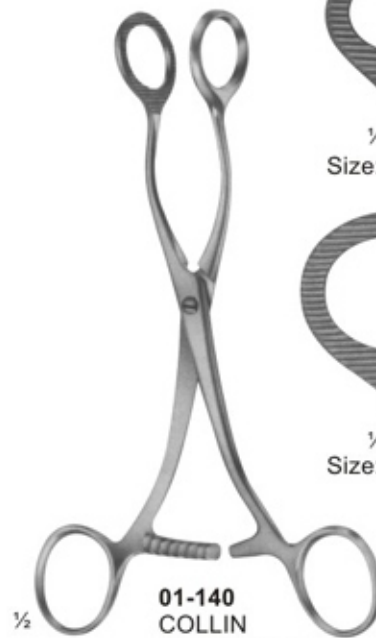

1/2
01-140
COLLIN
Size: 160 mm,
170 mm



1/4
Size: 160 mm



1/4
Size: 170 mm

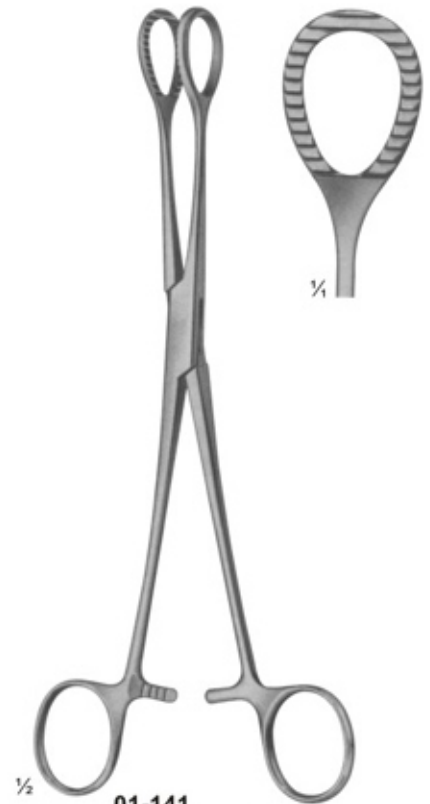

1/2
01-141
HEYWOOD-SMITH
modif. Size: 2

Blood Lancets and Laryngeal Mirrors

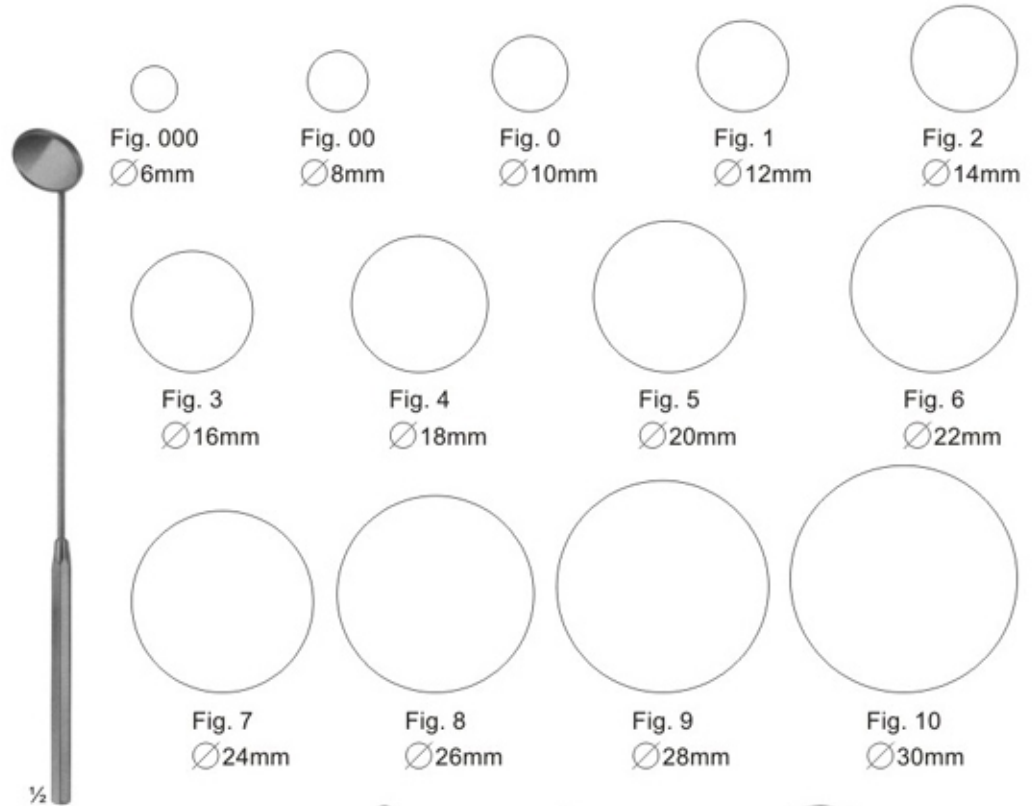

01-143
Laryngeal mirrors with hexagonal handle
Size: 180 mm



01-145
Mirror handle
Size: 110 mm



Laryngoscope and Diagnostic Sets



$\frac{1}{4}$
01-150
Infants
Size: 150 mm

$\frac{1}{4}$
01-151
Children
Size: 200 mm

$\frac{1}{4}$
01-152
Adults
Size: 250 mm

$\frac{1}{2}$
01-150 - 152
MAGILL



01-154



$\frac{1}{2}$
01-153
Medium battery handle
only, 25 mm diam.



01-153-A
Spare bulb
2.7 volt, for
otoscopes



01-153-B
Spare bulb
2.6 volt, for
ophthalmoscopes



01-155



01-156
Otoscope set, consists of
battery handle without batteries,
3 ear specula, 1 bulb in valvet lined case



01-157
Diagnostic set, otoscope with three specula,
nasal speculam, lamp holder, two laryngoscope
mirrors, tongue blade holder

Laryngoscopes



01-158
MILLER
 Laryngoscope set, consists of battery handle (without battery)
 with four miller laryngoscope blades

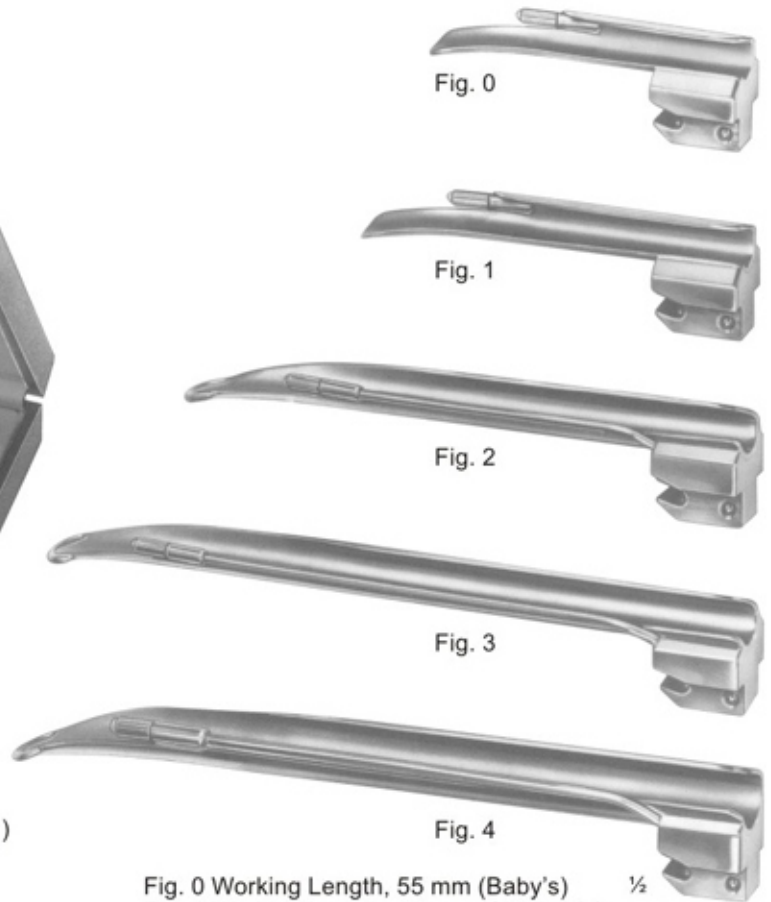

Fig. 0 Working Length, 55 mm (Baby's)
 Fig. 1 Working Length, 80 mm (Children's)
 Fig. 2 Working Length, 130 mm (Adolescent's)
 Fig. 3 Working Length, 170 mm (Women's)
 Fig. 4 Working Length, 180 mm (Men's)



01-159
GUEDEL-NEGUS
 Laryngoscope set, consists of battery handle (without battery)
 with four miller laryngoscope blades

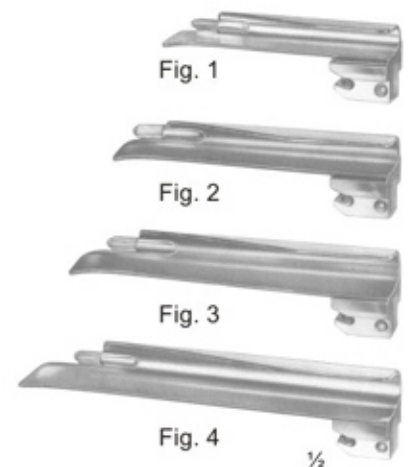

Fig. 1 Working Length, 70 mm (Children's)
 Fig. 2 Working Length, 90 mm (Adolescent's)
 Fig. 3 Working Length, 110 mm (Women's)
 Fig. 4 Working Length, 135 mm (Men's)

Laryngoscopes



01-160
McINTOSH
Laryngoscope Set, Consists Of Battery Handle (Without Battery)
With Three McIntosh Blades, Fig. 1, Fig. 2, Fig. 3

01-161
McINTOSH
Laryngoscope Set, Consists Of Battery Handle (Without Battery)
With Five McIntosh Blades, Fig. 0, Fig. 1, Fig. 2, Fig. 3, Fig. 4

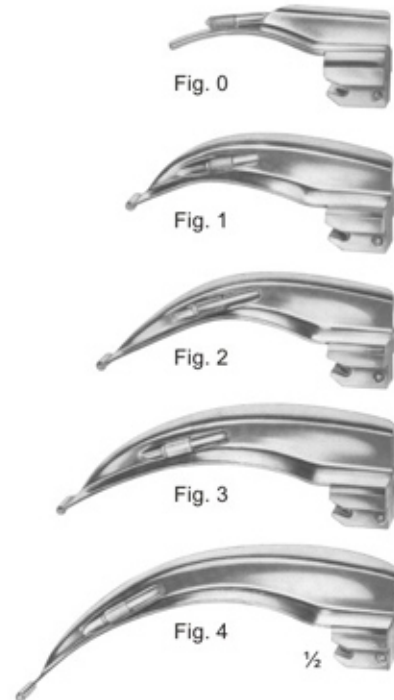

01-161 A Fig. 0 Working Length, 55 mm (Baby's)
01-161 B Fig. 1 Working Length, 75 mm (Children's)
01-161 C Fig. 2 Working Length, 90 mm (Adolescent's)
01-161 D Fig. 3 Working Length, 110 mm (Women's)
01-161 E Fig. 4 Working Length, 135 mm (Men's)

01-162
FOREGGER
Laryngoscope Set, Consists Of
Battery Handle (Without Battery)
With Three Foregger Blades,
Fig. 1, Fig. 2, Fig. 3,



01-163
FOREGGER
Laryngoscope Set, Consists Of
Battery Handle (Without Battery)
With Four Foregger Blades,
Fig. 1, Fig. 2, Fig. 3, Fig. 4,

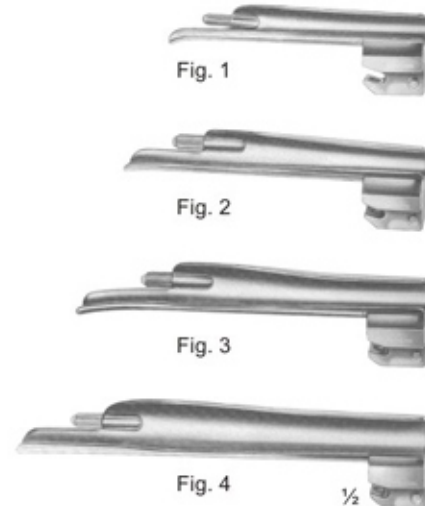

01-162 A Fig. 1 Working Length, 70 mm (Children's)
01-162 B Fig. 2 Working Length, 90 mm (Adolescent's)
01-162 C Fig. 3 Working Length, 110 mm (Women's)
01-162 D Fig. 4 Working Length, 135 mm (Men's)



01-164
Fiber Optic
Battery Handle
30mm diam.



01-165
Fiber Optic
Battery Handle
18mm diam.



01-166
Replacement Lamp
(Krypton) 2.5 V



01-167
Replacement
(Halogen) 2

Examination & Measuring Instruments

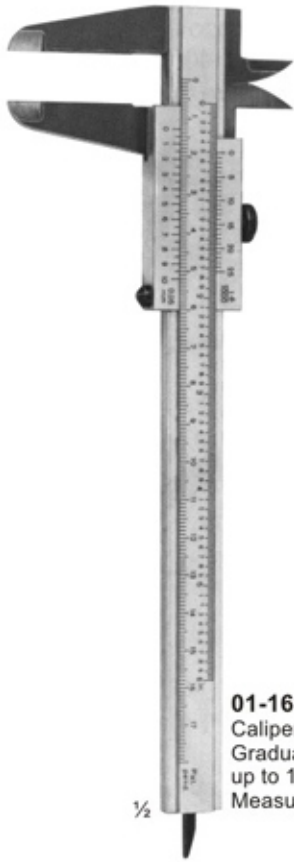

01-168
Caliper Of Aluminium
Graduated in mm & inches
up to 180mm
Measuring Range up to 139mm



01-169
VERNIER
Universal Caliper Of Steel
Graduated in mm & inches
up to 180mm
Measuring Range up to 120mm
with Vernier in 1/10mm & 1/16"



01-170
CARROLL
Size: 145 mm
Finger Goniometer



01-171
TOWNLEY
Graduated in
mm & inches
Size: 115 mm



01-172
COLLIN
Druck Pressure 72 kg
Size: 125 mm



01-173
BERTILLON
Caliper For Measuring The Head
Size: 320 mm



01-174
CASTROVIEJO
Caliper
Size: 75mm



01-175
MOLTGEN
Goniometer



01-176
Size: 150 mm



01-177
Size: 500 mm



Dissecting Knives



1/2
02-101 - 110
Fig. 1 - 10



02-101
Fig. 1
30 mm



02-102
Fig. 2
36 mm



02-103
Fig. 3
40 mm



02-104
Fig. 4
45 mm



02-105
Fig. 5
50 mm



02-106
Fig. 6
27 mm



02-107
Fig. 7
35 mm



02-108
Fig. 8
40 mm



02-109
Fig. 9
47 mm



02-110
Fig. 10
50 mm

Amputating Knives, Cartilage Knives and Autopsy Knives



LISTON
02-111
 Size: 130 mm
02-112
 Size: 160 mm
02-113
 Size: 190 mm
02-114
 Size: 200 mm

02-115
CATLIN
 Size: 160 mm
 Blade length
 Amputating
 Knives

02-116
LANGENBECK
 Size: 120 mm
 Blade length
 Flap Knives

02-117
 Size: 110 mm
 Blade length
 Interosseous
 Knives

02-118
 Size: 55 mm
 Blade length
 with raspatory,
 Wooden handle

02-119
 Size: 70 mm
 Blade length
 Wooden handle

02-120
 Size: 80 mm
 Blade length
 Metal handle

02-121
 Size: 195 mm
 Blade length
 Metal handle

Blade length
 Amputating Knives

Cone Knives, Myomatome, Trigeminal and Tonsil Knives



Scalpel Handles

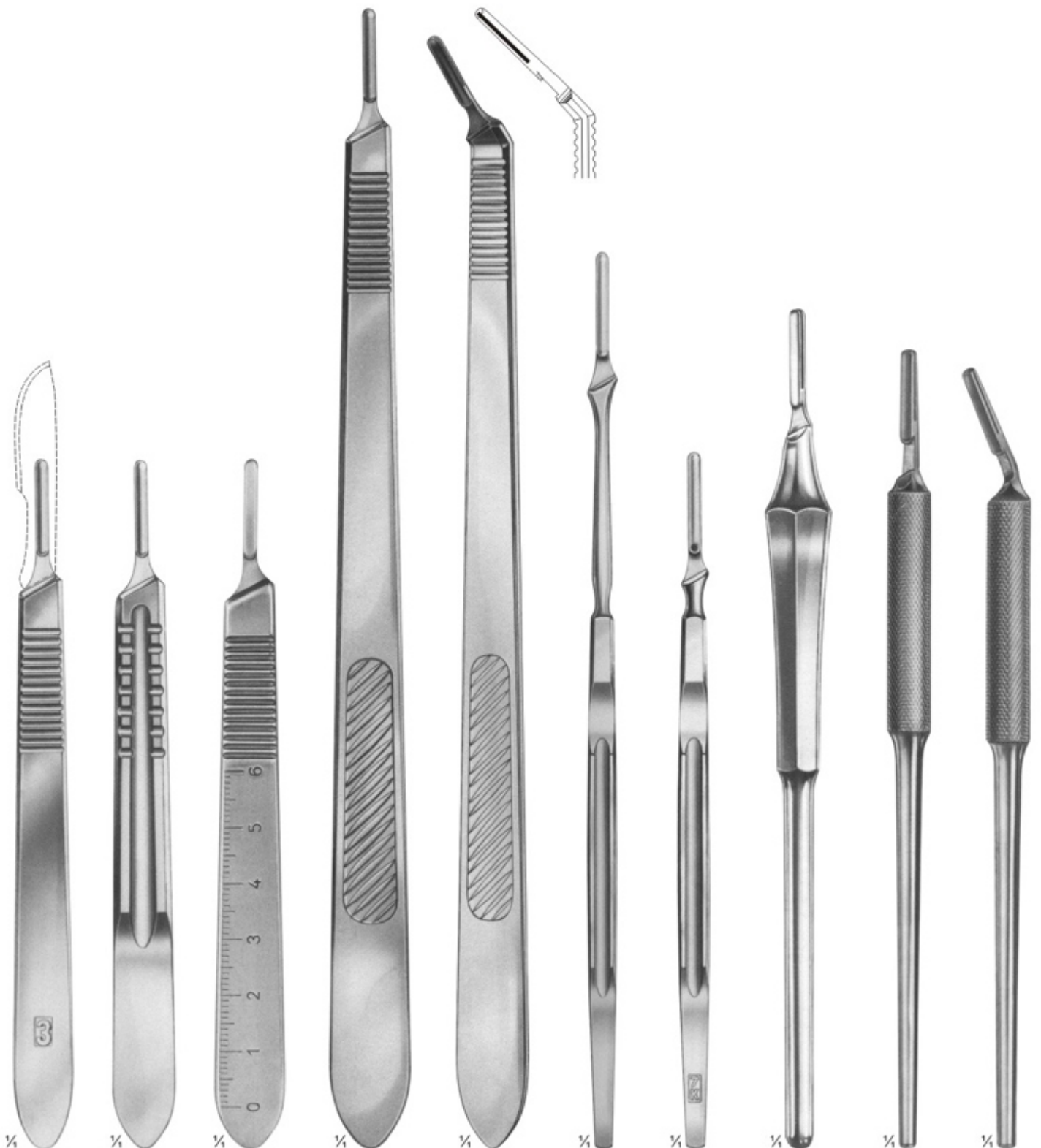

02-130 STANDARD No. 3 Solid 12 cm	02-131 No. 3 Solid 12 cm	02-132 No. 3 Solid 12 cm	02-133 No. 3 L Straight Solid 21.5 cm	02-134 No. 3 L Angled Solid 21 cm	02-135 No. 7 Solid 16 cm	02-136 No. 7 K Solid 12.5 cm	02-137 Hollow-Round 15.5 cm	02-138 No. 3 Straight Solid, Round 14.5 cm	02-139 No. 3 Angled Solid, Round 14 cm
--	--	--	--	--	--	--	--	--	--

Micro Scissors (Spring Type) with Flat Handles

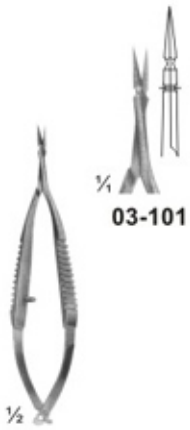

03-101 - 103
VANNAS
Size: 85 mm



03-104 - 105
CASTROVIEJO
Size: 95 mm

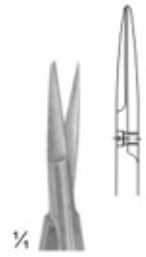

03-106
NOYES
Size: 125 mm



03-107 - 108
WECKER
Eye scissor
Size: 110 mm

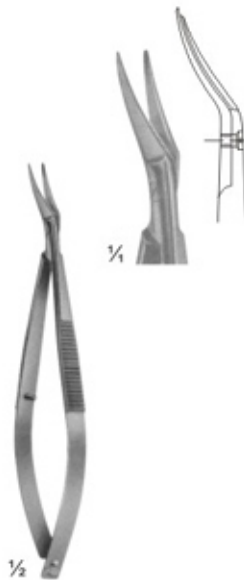

03-109
CASTROVIEJO
Eye scissor
Size: 115 mm



03-110 - 111
CASTROVIEJO
Eye scissor
Size: 110 mm

Micro Scissors (Spring Type) with Flat Handles

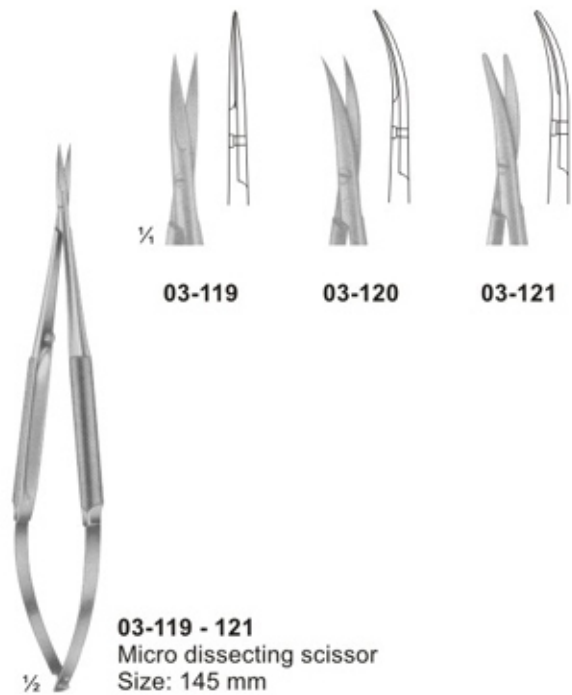
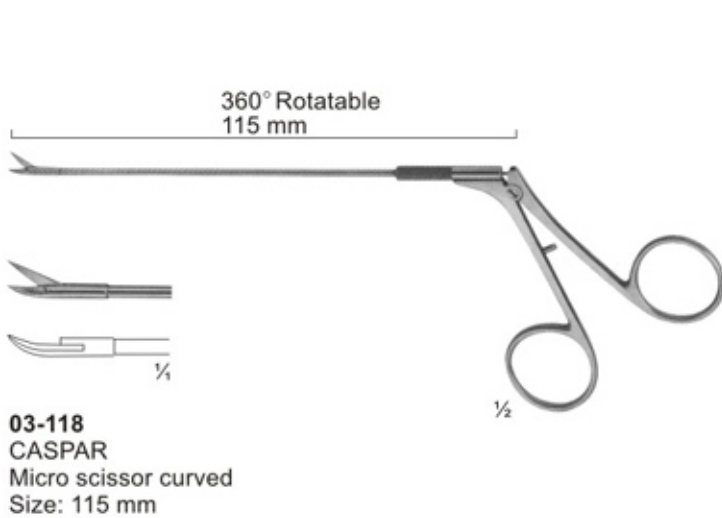
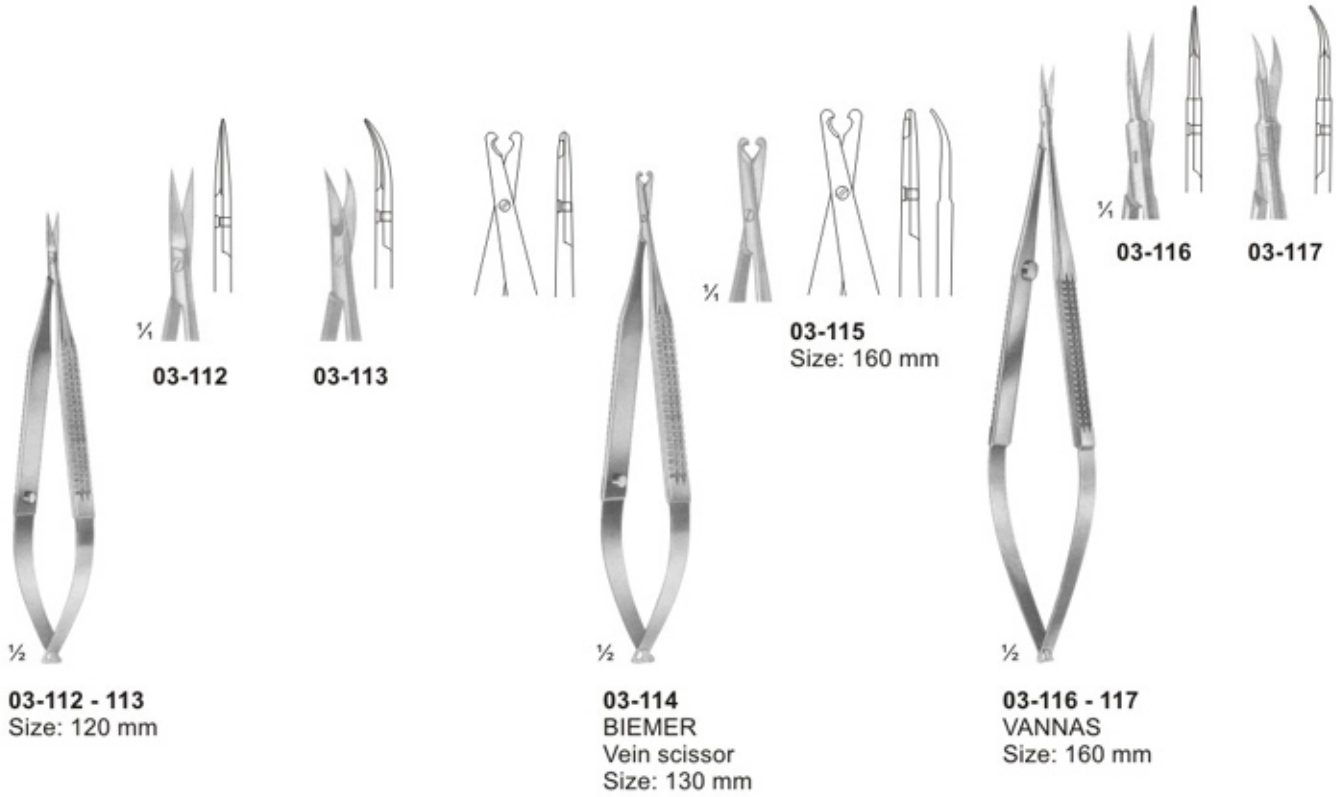

Micro Scissors (Spring Type) bayonet-Shaped



1/2
03-122
YASARGIL
 Size: 245 mm



1/4
03-123
 45°



1/4
03-124
 45°



1/2
03-123 - 124
 laterally angled
 Size: 200 mm



125°



1/2
03-125
 laterally angled
 Size: 190 mm

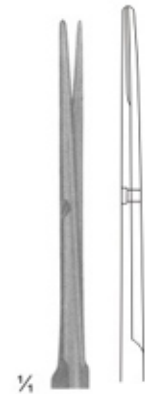

1/4
03-126



1/4
03-127



1/2
03-126 - 127
YASARGIL
 Size: 225 mm

Delicate Scissors



03-128 - 129
Size: 90 mm

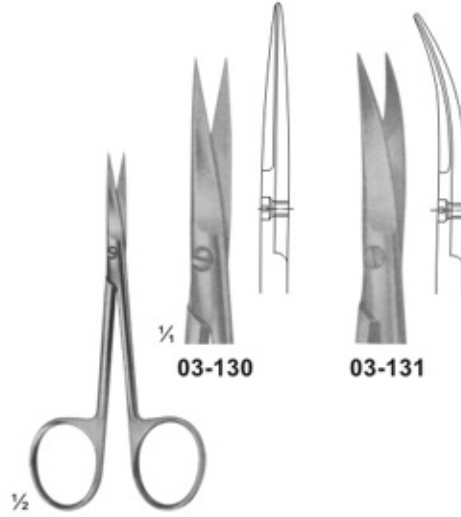

03-130 - 131
Size: 95 mm

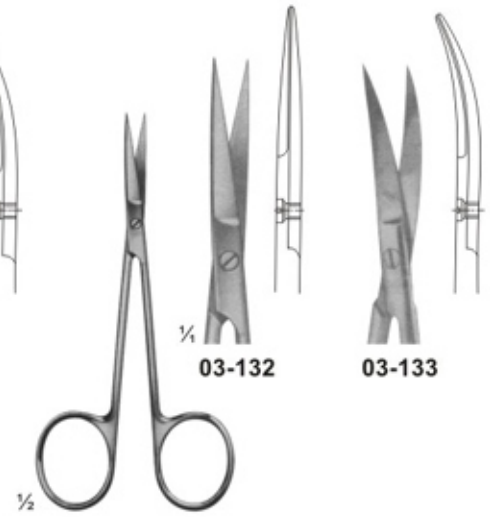

03-132 - 133
Size: 105 mm

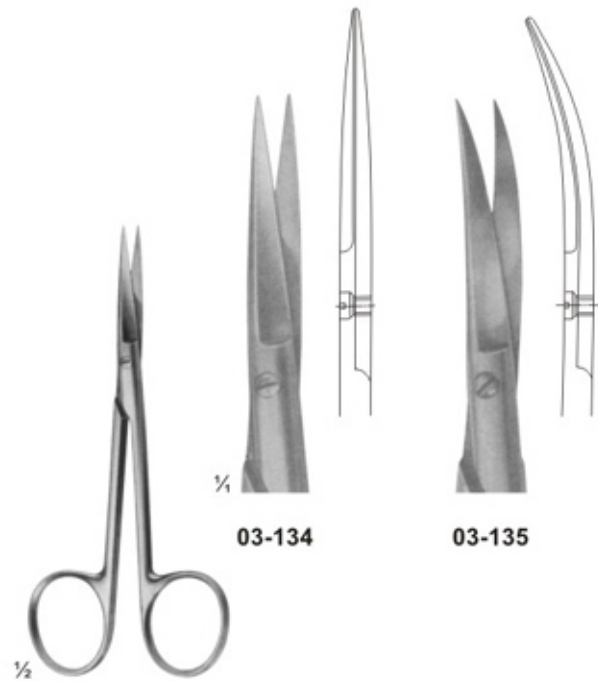

03-134 - 135
Size: 120 mm



03-136 - 137
Size: 115 mm

Delicate Scissors



03-138 - 140
Size: 120 mm

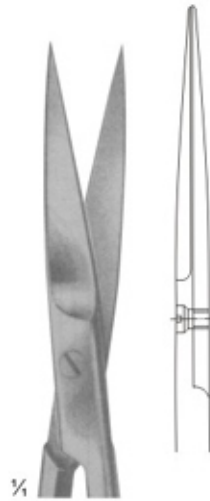

03-138

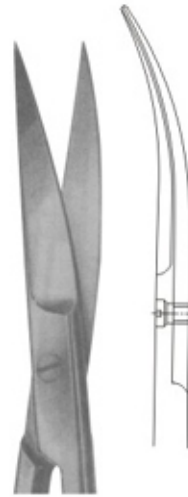

03-139



03-140



03-141 - 144
Size: 130 mm

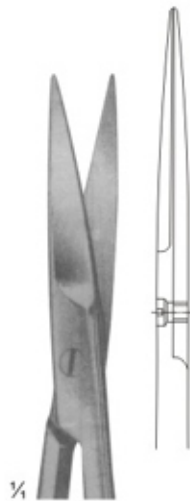

03-141

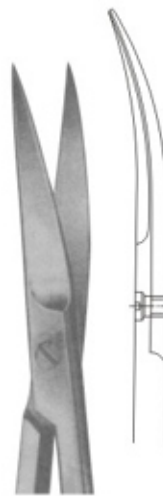

03-142

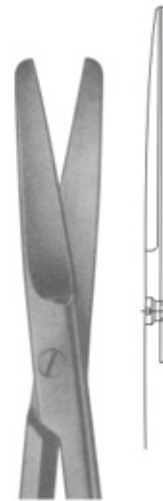

03-143

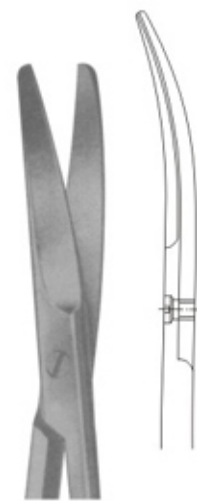

03-144

Surgical Scissors

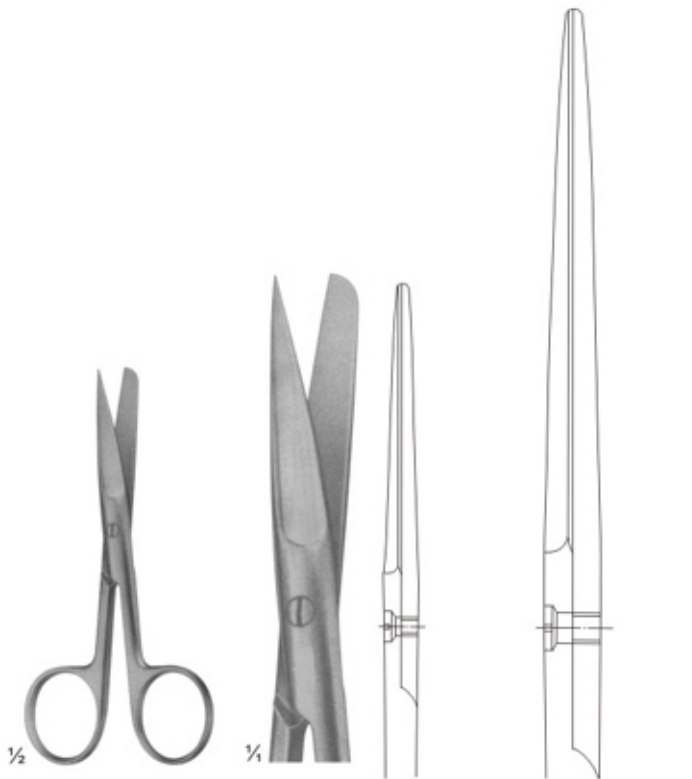

03-145 - 153 (Standard types)
03-145 (105 mm)
03-146 (115 mm)
03-147 (130 mm)
03-148 (145 mm)
03-149 (150 mm)
03-150 (165 mm)
03-151 (175 mm)
03-152 (185 mm)
03-153 (200 mm)

03-145
Size: 105 mm

03-153
Size: 200 mm



03-154 - 160 (Standard types)
03-154 (115 mm)
03-155 (130 mm)
03-156 (145 mm)
03-157 (150 mm)
03-158 (165 mm)
03-159 (175 mm)
03-160 (185 mm)

03-154
Size: 115 mm

03-160
Size: 185 mm

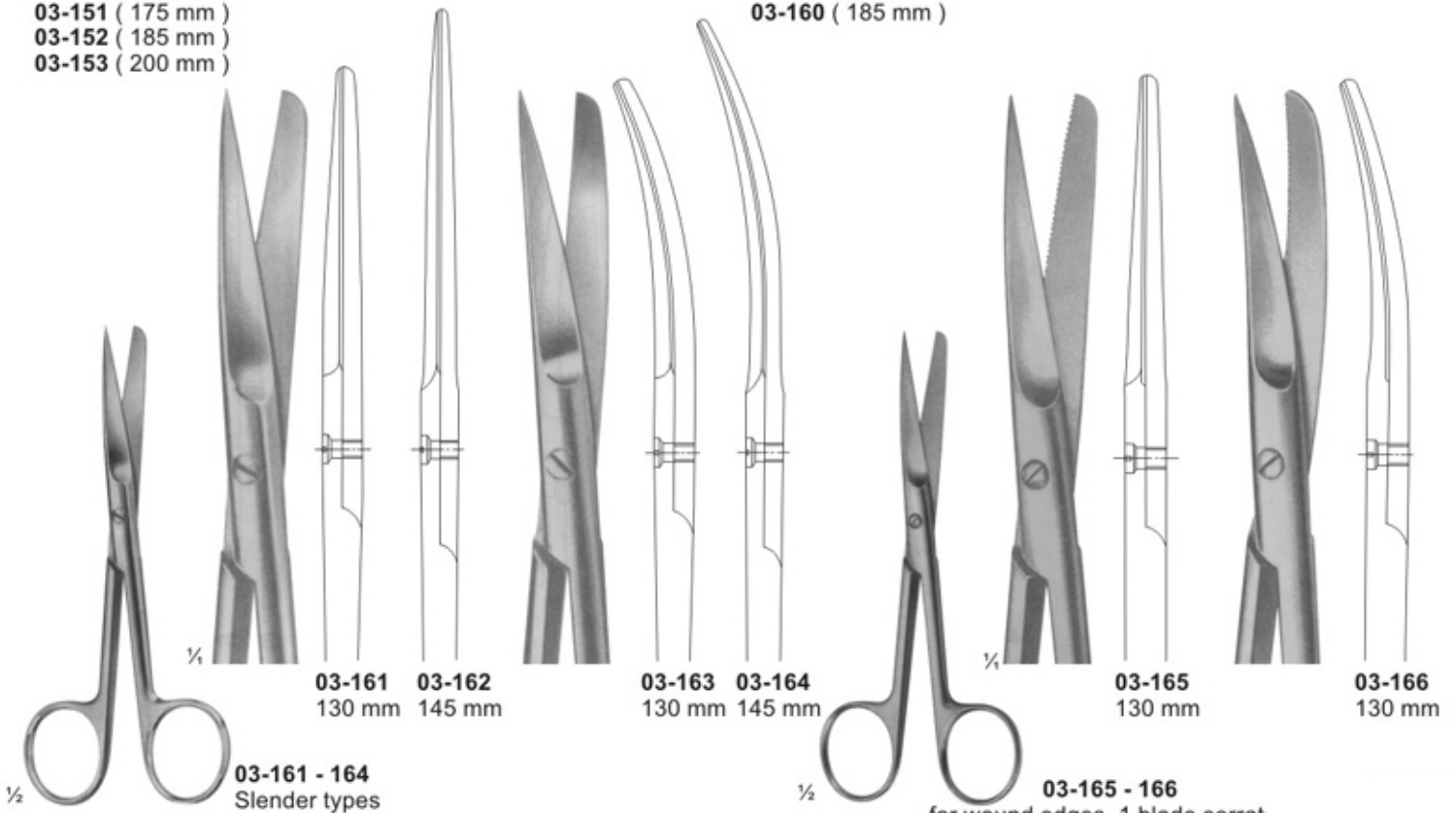

03-161 130 mm
03-162 145 mm

03-163 130 mm
03-164 145 mm

03-165 130 mm

03-166 130 mm

03-161 - 164
Slender types

03-165 - 166
for wound edges. 1 blade serrat

Surgical Scissors



03-167 - 169
DEAVER
with flat lock

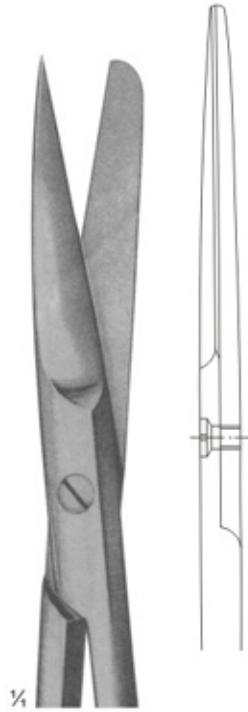

03-167
Size: 145 mm

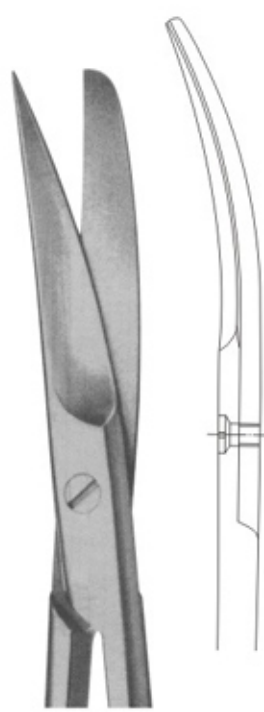

03-168
Size: 145 mm

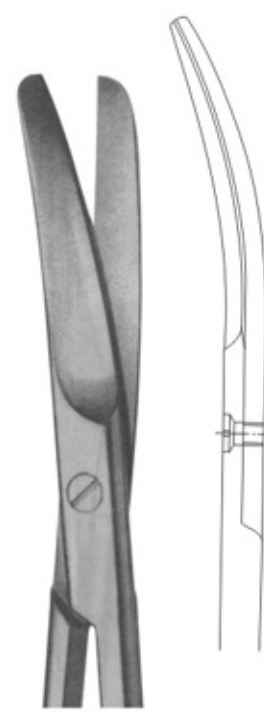

03-169
Size: 145 mm



03-170 - 172
Incision scissors



03-170
Size: 130 mm



03-171
Size: 145 mm



03-172
Size: 165 mm



03-173
SYSTRUNK
Nail splitting scissors

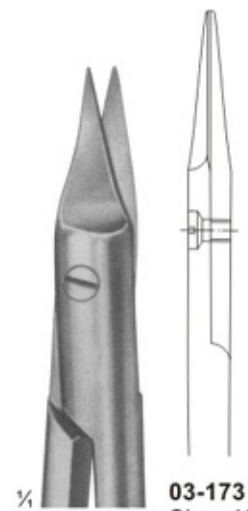

03-173
Size: 130 mm

Dissecting Scissors

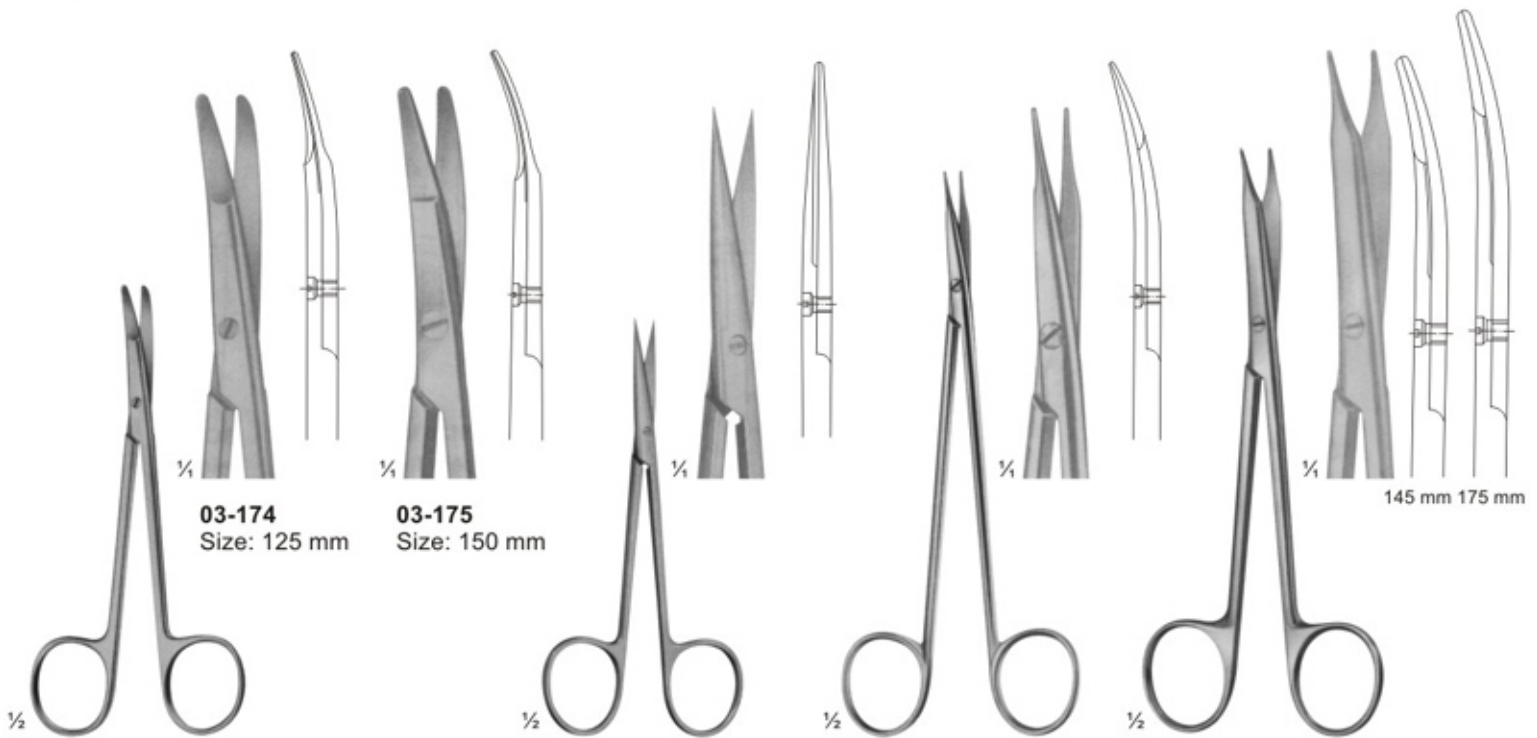

03-174 - 175
KILNER
 Special flat points for dissecting and undermining the skin

03-176
KILNER
 Fine dissecting scissors
 Size: 115 mm

03-177
JAMESON
 Dissecting scissors
 Size: 150 mm

03-178
REYNOLDS
 Dissecting scissors
 Size: 145 - 175 mm

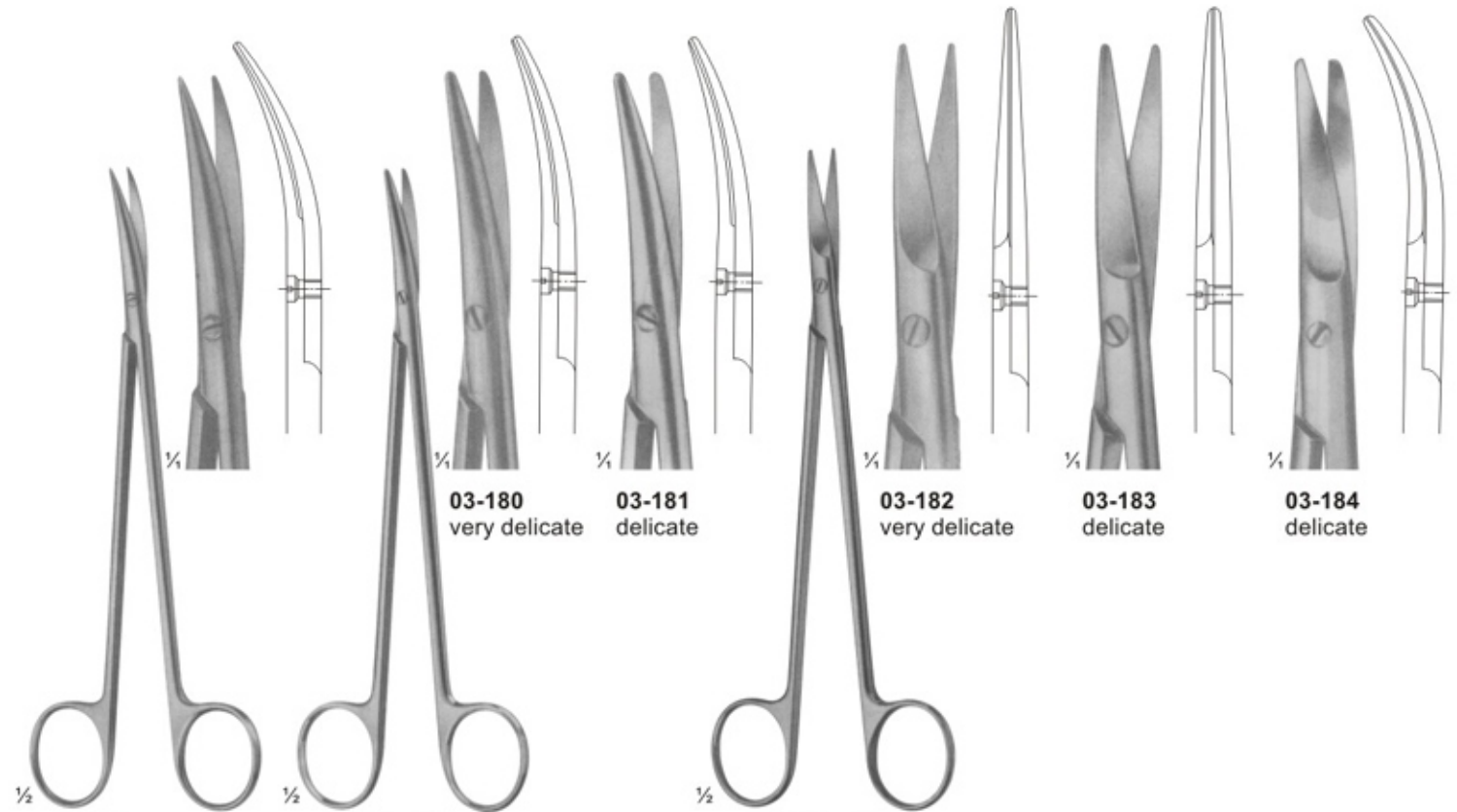

03-179
DE BAKEY
 Arteriotomy scissors
 Size: 175 mm

03-180 - 181
TOENNIS ADSON
 Dissecting scissors
 Size: 175 mm

03-182 - 184
TOENNIS
 Dissecting scissors
 Size: 180 mm

Dissecting Scissors

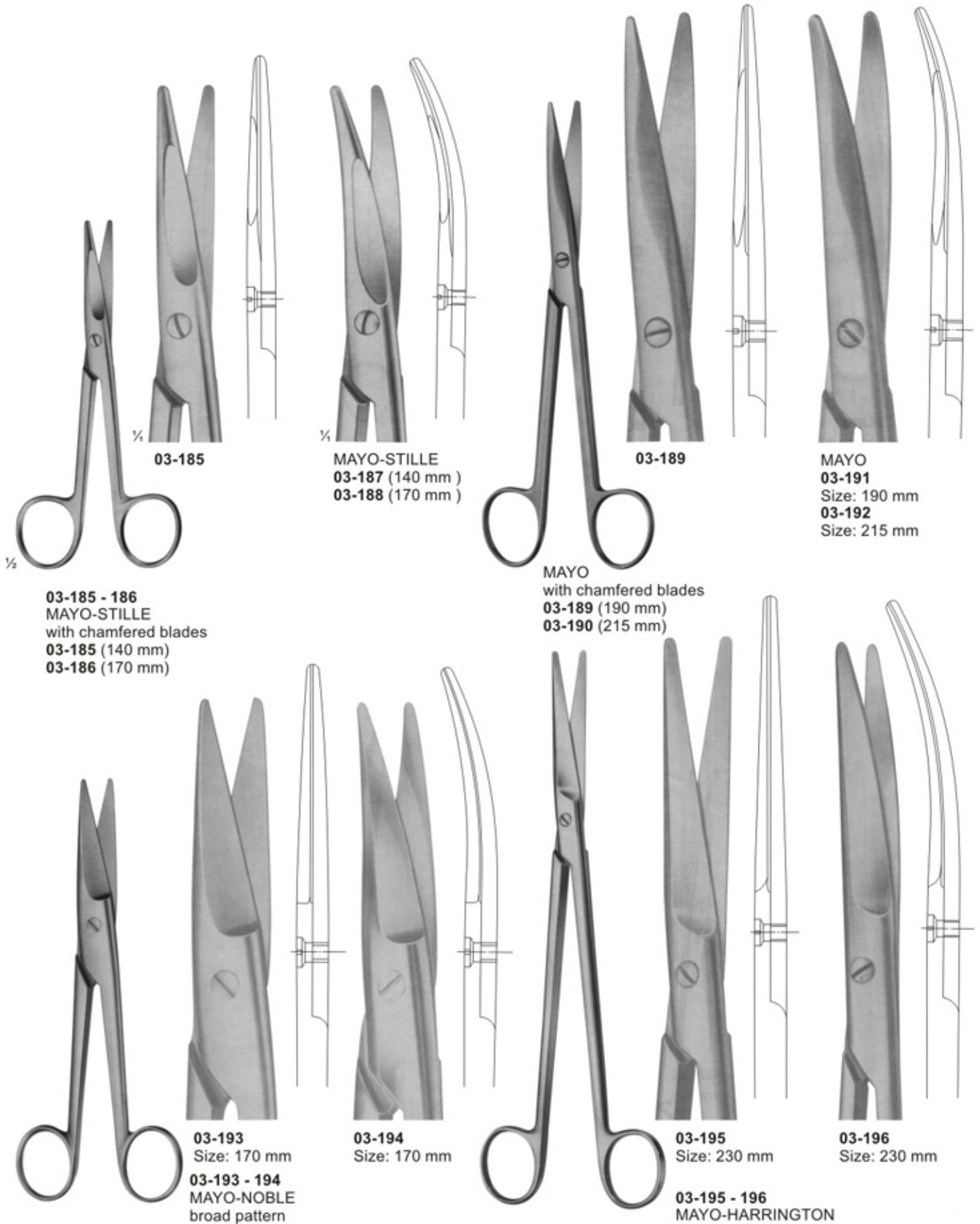

Scissors for Cardiovascular and Neuro-Surgery



1/2 **03-197**
OLIVECRONA
Dura scissors

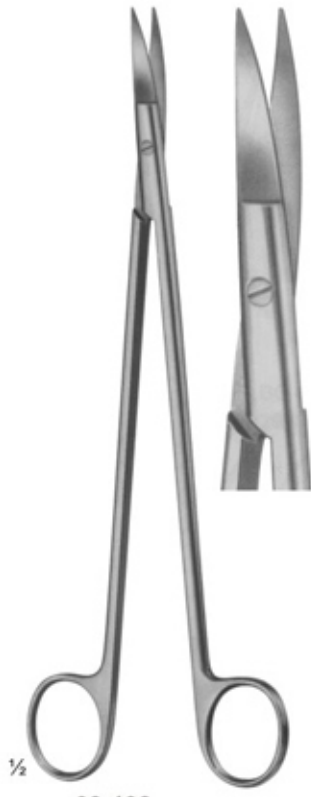

1/2 **03-198**
STRULLY
pointed
Size: 220 mm

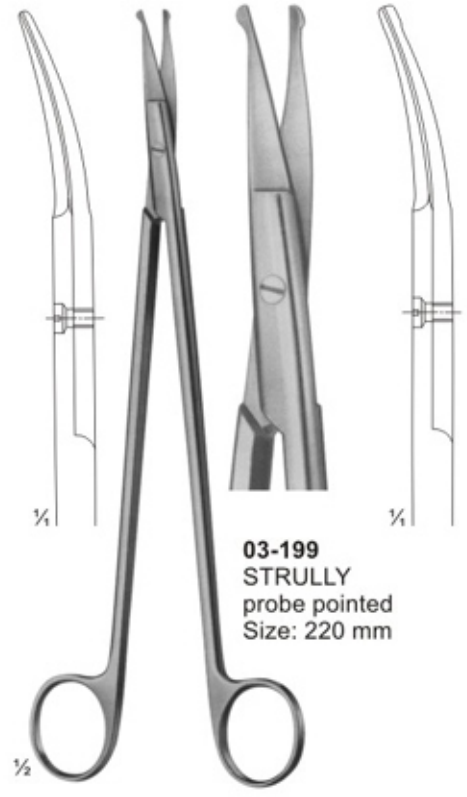

03-199
STRULLY
probe pointed
Size: 220 mm

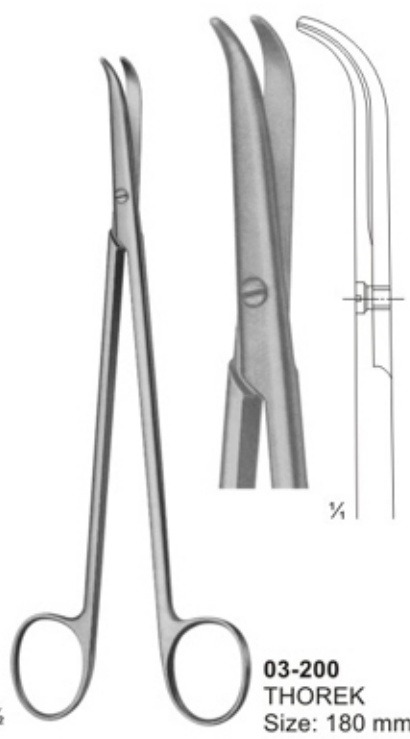

1/2 **03-200**
THOREK
Size: 180 mm

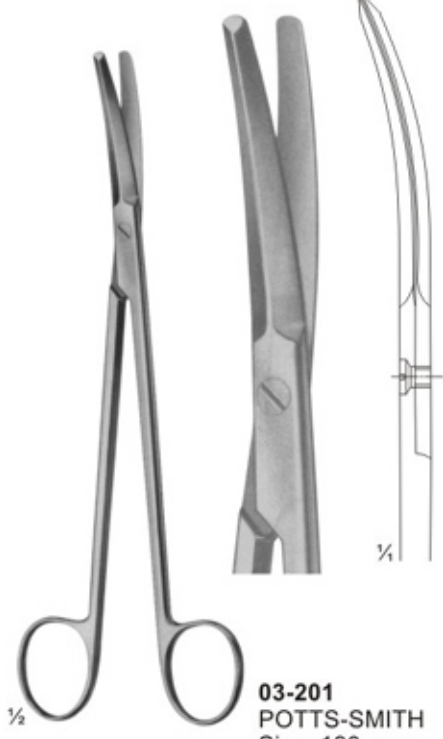

1/2 **03-201**
POTTS-SMITH
Size: 190 mm

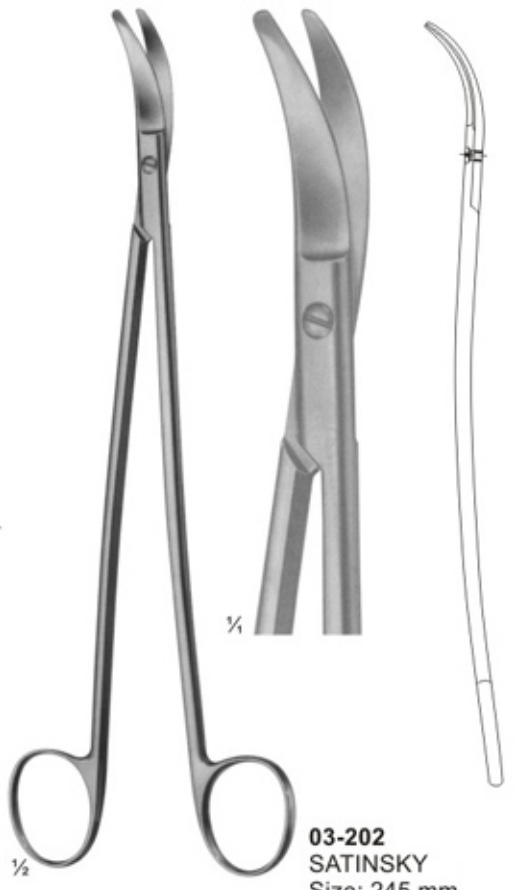

1/2 **03-202**
SATINSKY
Size: 245 mm

Delicate, Nasal and Tonsil Scissors

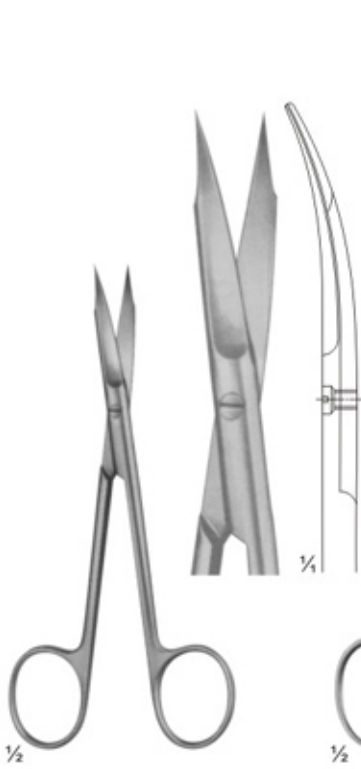

03-203
1 finely toothed blade
Size: 130 mm

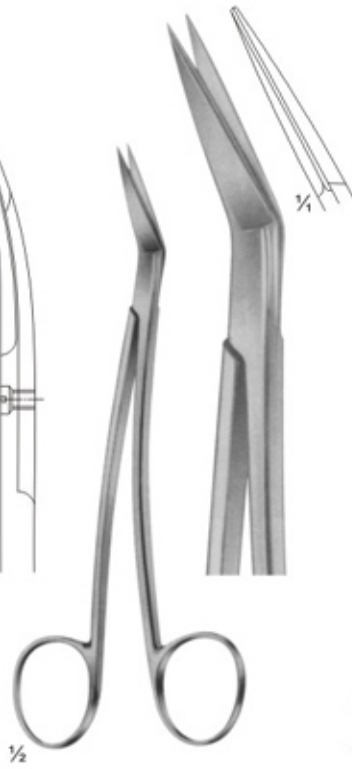

03-204
LOCKLIN
curved sideways,
1 toothed blade
Size: 155 mm

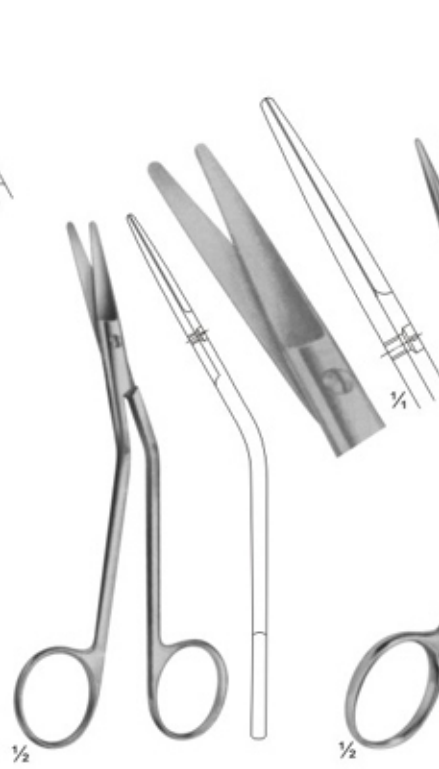

03-205
FOMON
blades serrated
Size: 145 mm

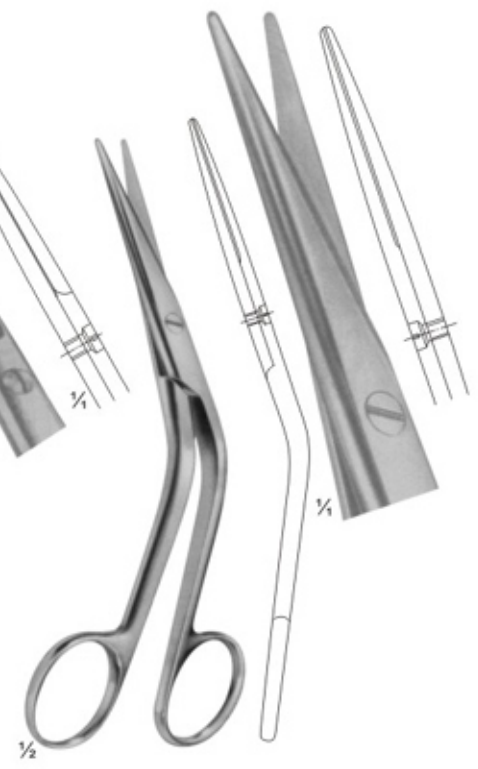

03-206
COTTLE
Size: 165 mm



03-207
HEYMANN-KNIGHT
Size: 175 mm

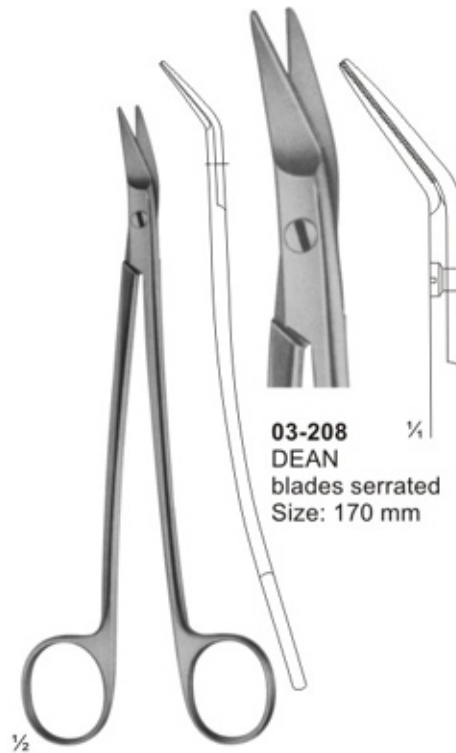

03-208
DEAN
blades serrated
Size: 170 mm

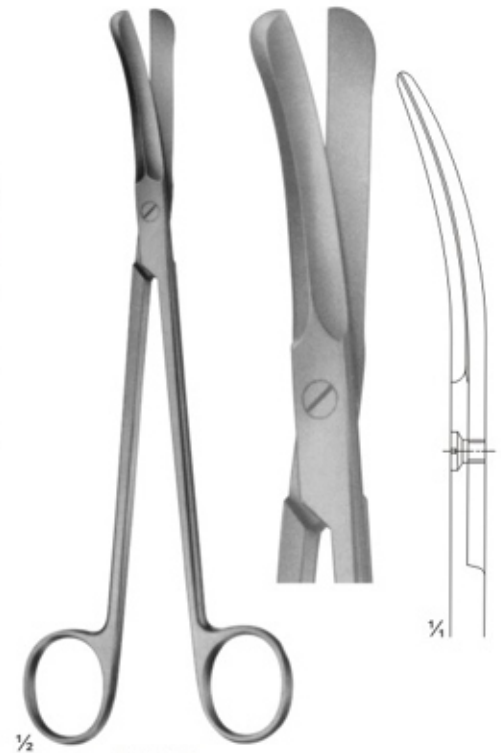

03-209
GOOD
Size: 195 mm

Bone Shears

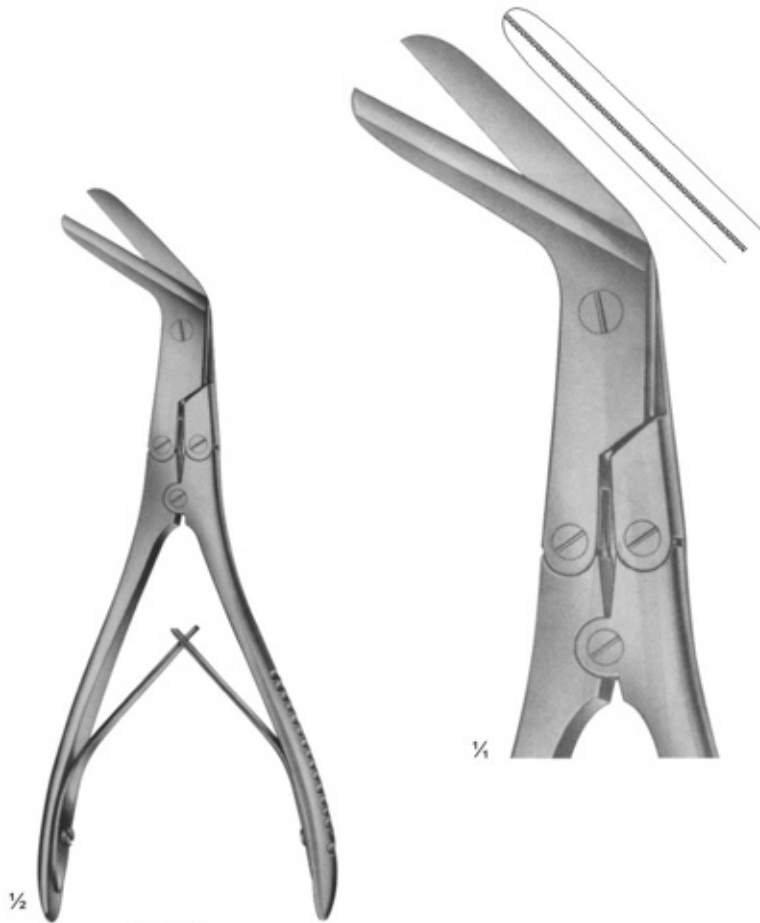

03-210
KILLIAN
Size: 200 mm



03-211 - 03-212

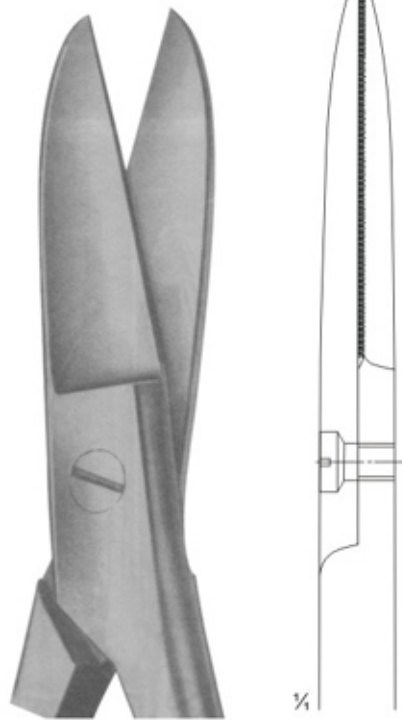

03-211
195 mm



03-212
225 mm

Scissors for deep operations and for Gynaecology

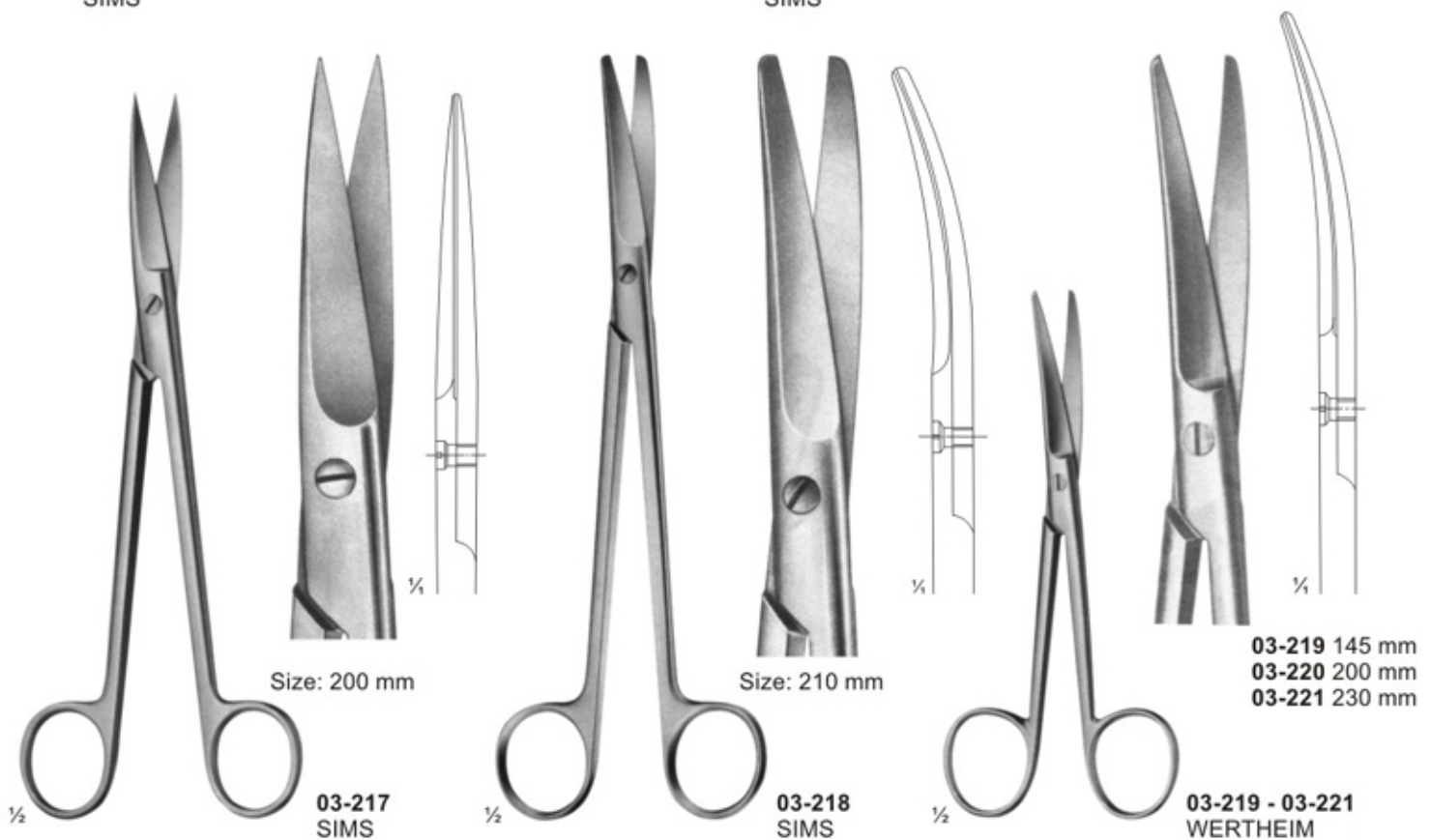
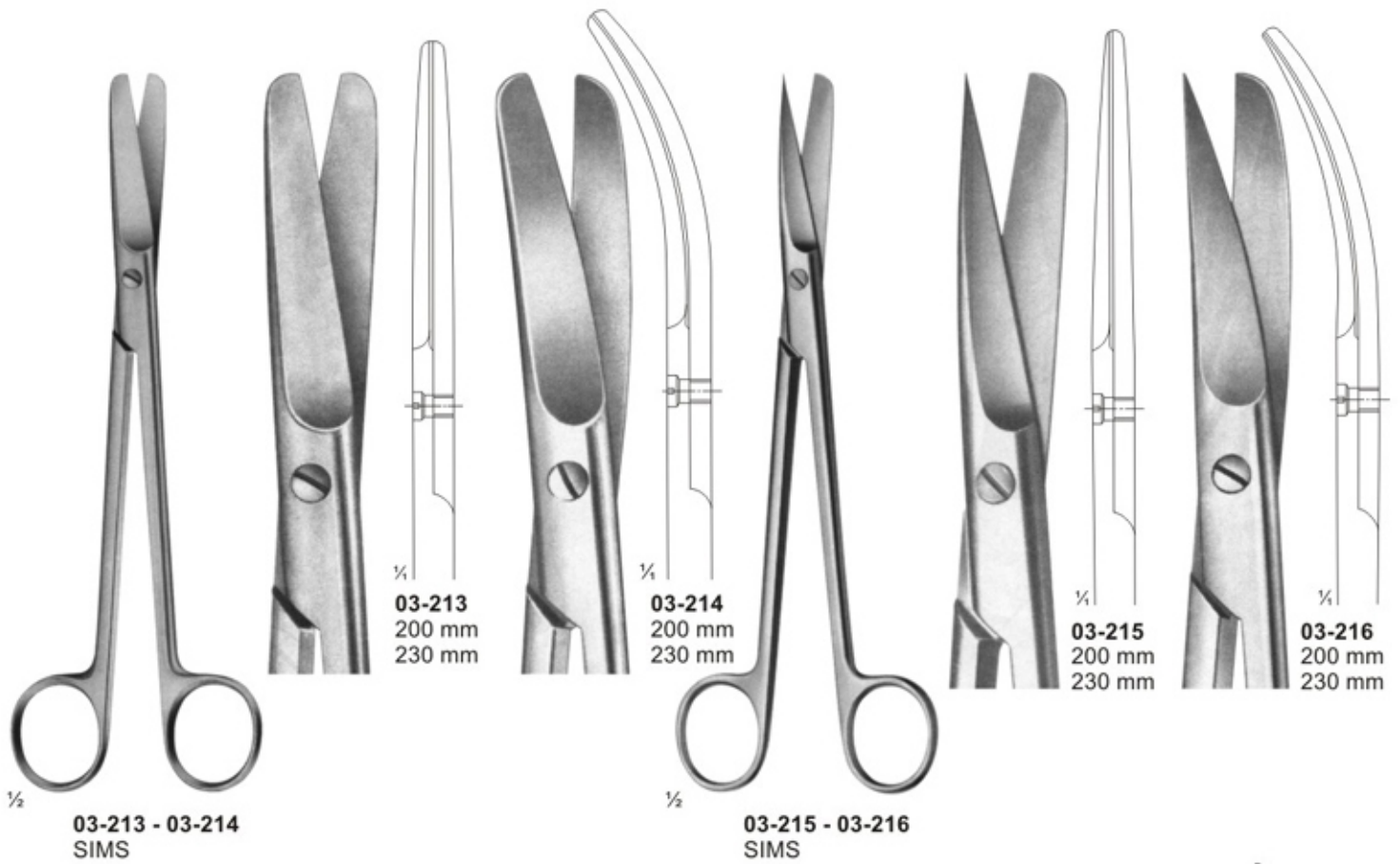

Scissors for Obstetrics



03-222
SCHUMACHER
 Umbilical cord scissors
 Size: 155 mm

03-223
 Umbilical cord scissors
 Size: 105 mm

03-224
 Umbilical cord scissors

135 mm



03-225 - 03-226
BRAUN-STADLER
 Episiotomy scissors

03-225
 145 mm

03-226
 200 mm

03-227
 Episiotomy scissors
 240 mm

Wire and Plate Scissors

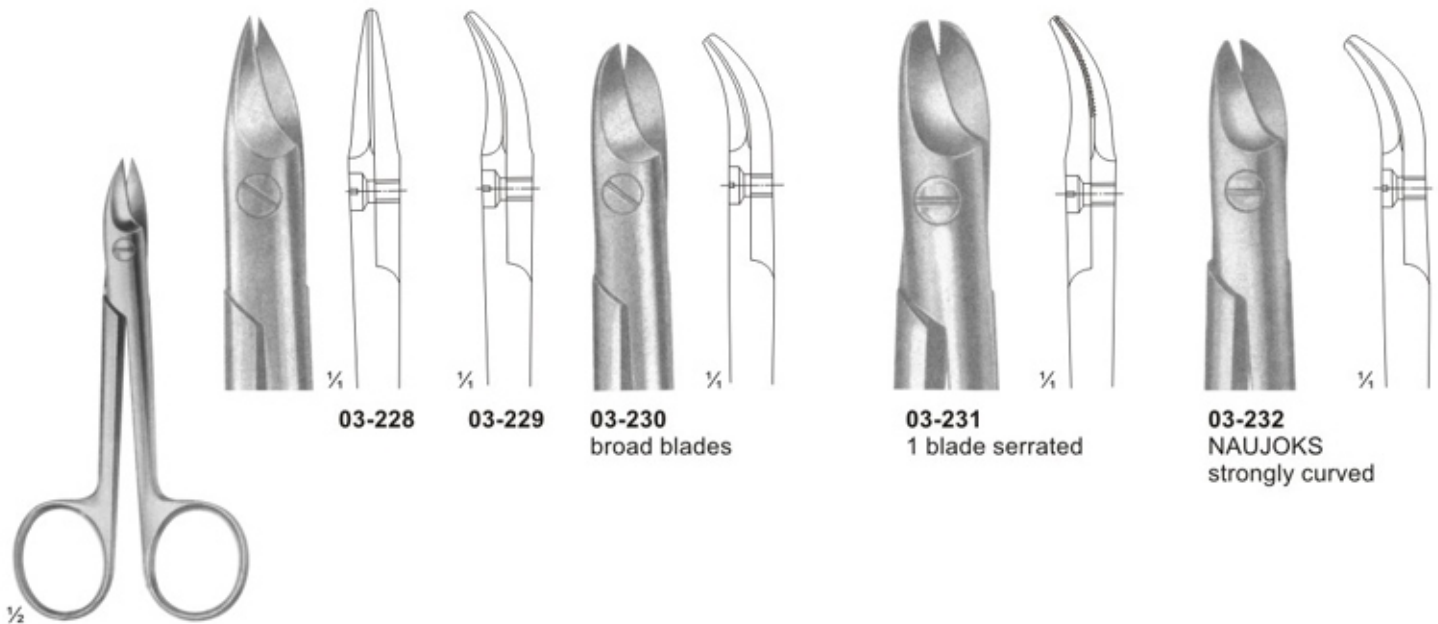

03-228 - 03-232
BEEBE
Size: 110 mm

03-228

03-229

03-230
broad blades

03-231
1 blade serrated

03-232
NAUJOKS
strongly curved

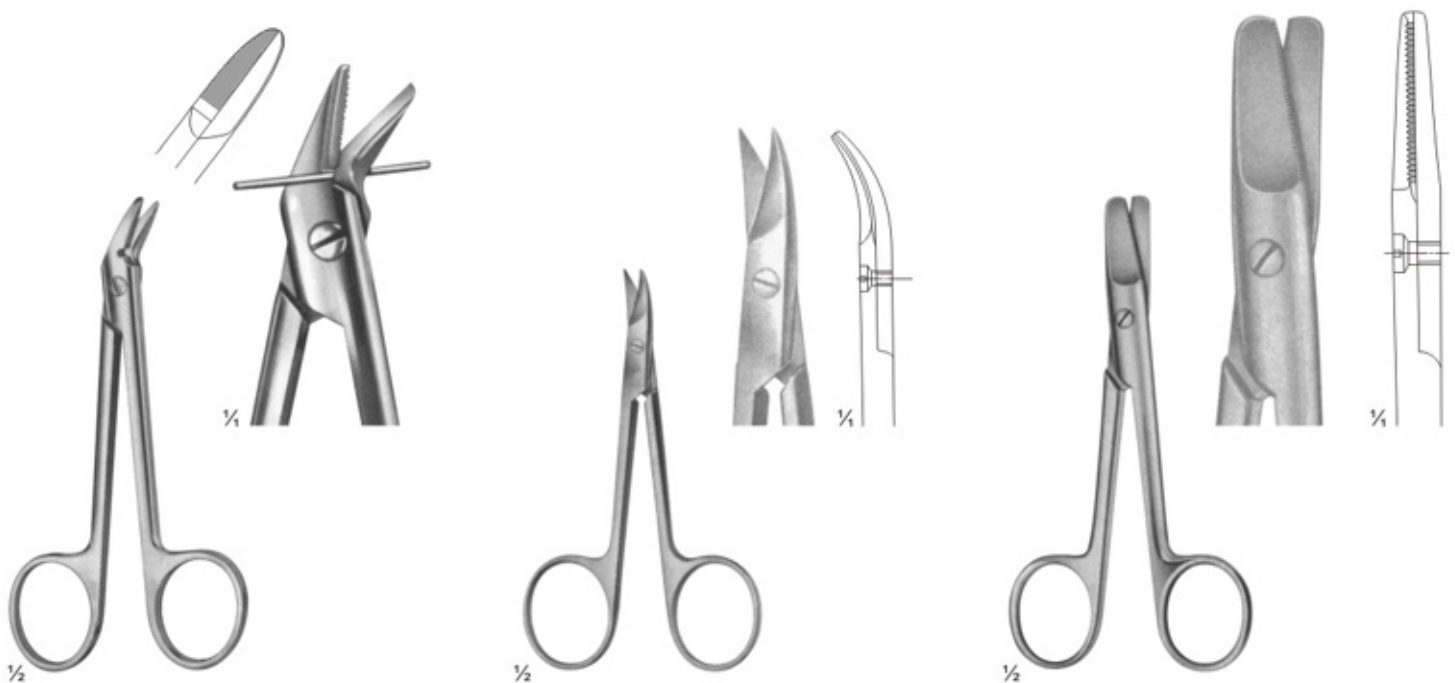

03-233
1 blade serrated
Size: 120 mm

03-234
STRACK
Size: 100 mm

03-235
HARVEY
blades serrated
Size: 125 mm

Bandage and Cloth Scissors



03-236
 Universal bandage and cloth scissors,
 with toothed edges
 180 mm



03-237
 LISTER
 Universal bandage and cloth scissors,
 with toothed edges
 Size: 145 mm

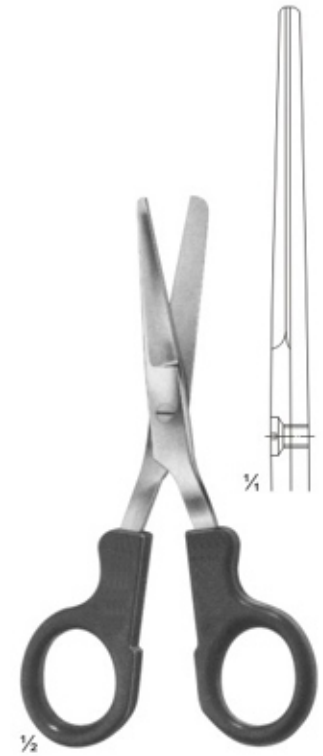

03-238
 LISTER
 Nurse's scissors
 Size: 145 mm

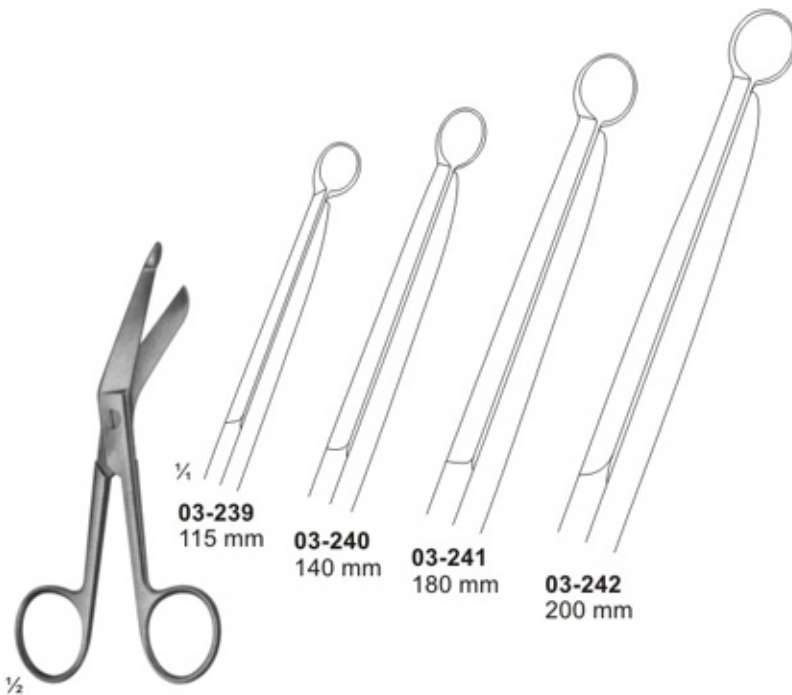

03-239 - 03-242
 LISTER

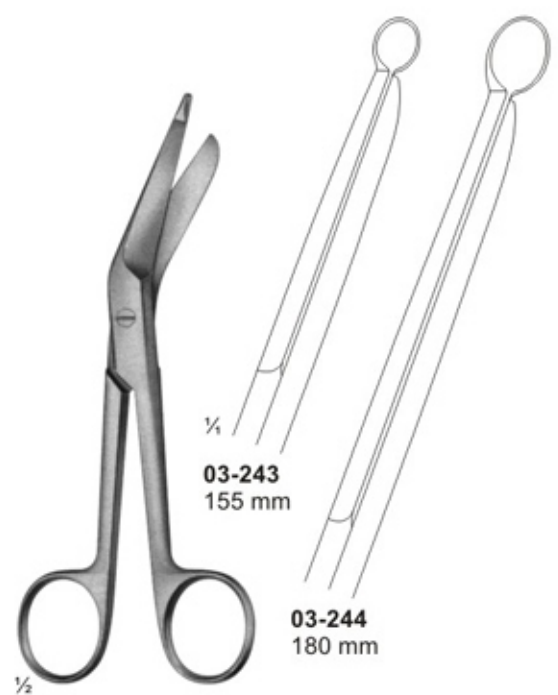

03-243 - 03-244
 LISTER

Bandage-, Cloth-, and Plaster Scissors



03-245
CLOTH SCISSORS
205 mm

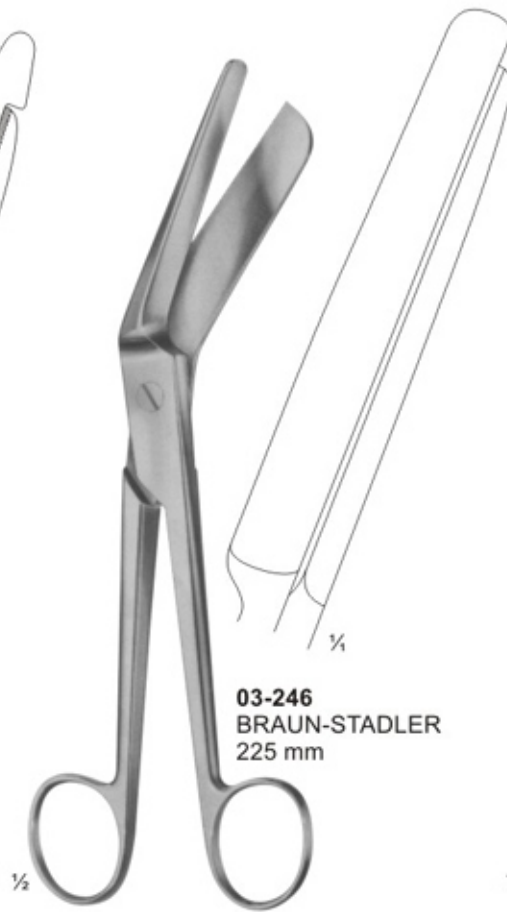

03-246
BRAUN-STADLER
225 mm



03-247
SEUTIN
230 mm

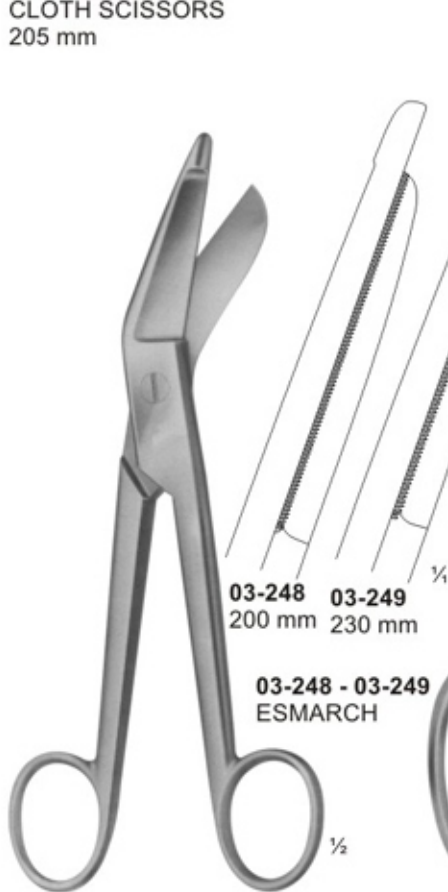

03-248 200 mm
03-249 230 mm

03-248 - 03-249
ESMARCH

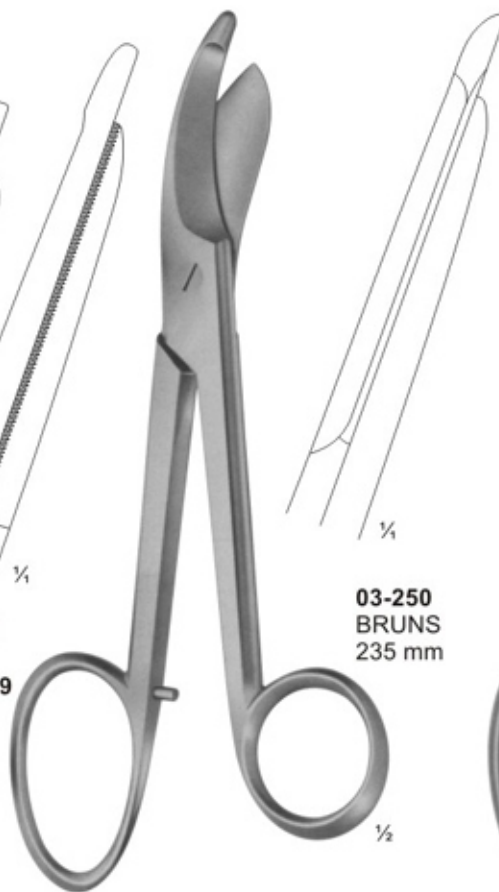

03-250
BRUNS
235 mm

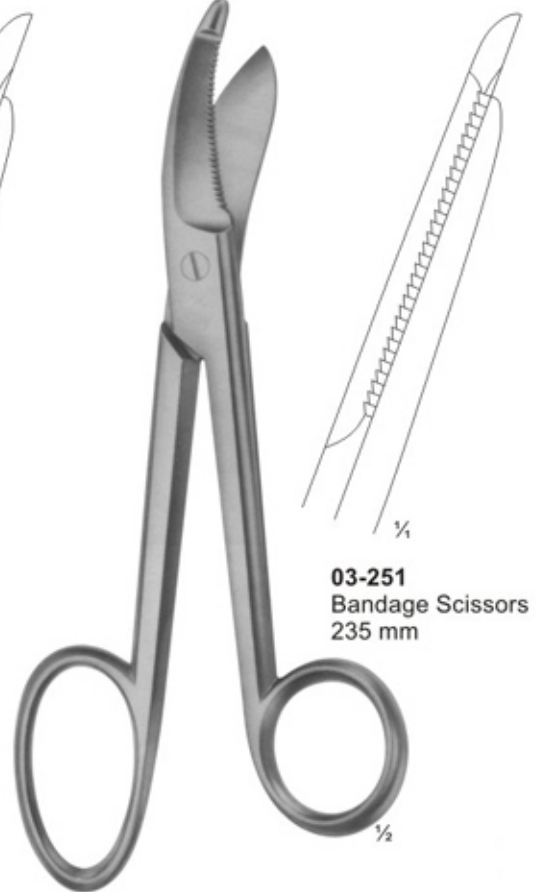

03-251
Bandage Scissors
235 mm

Forceps for grasping tissue, tumors etc.

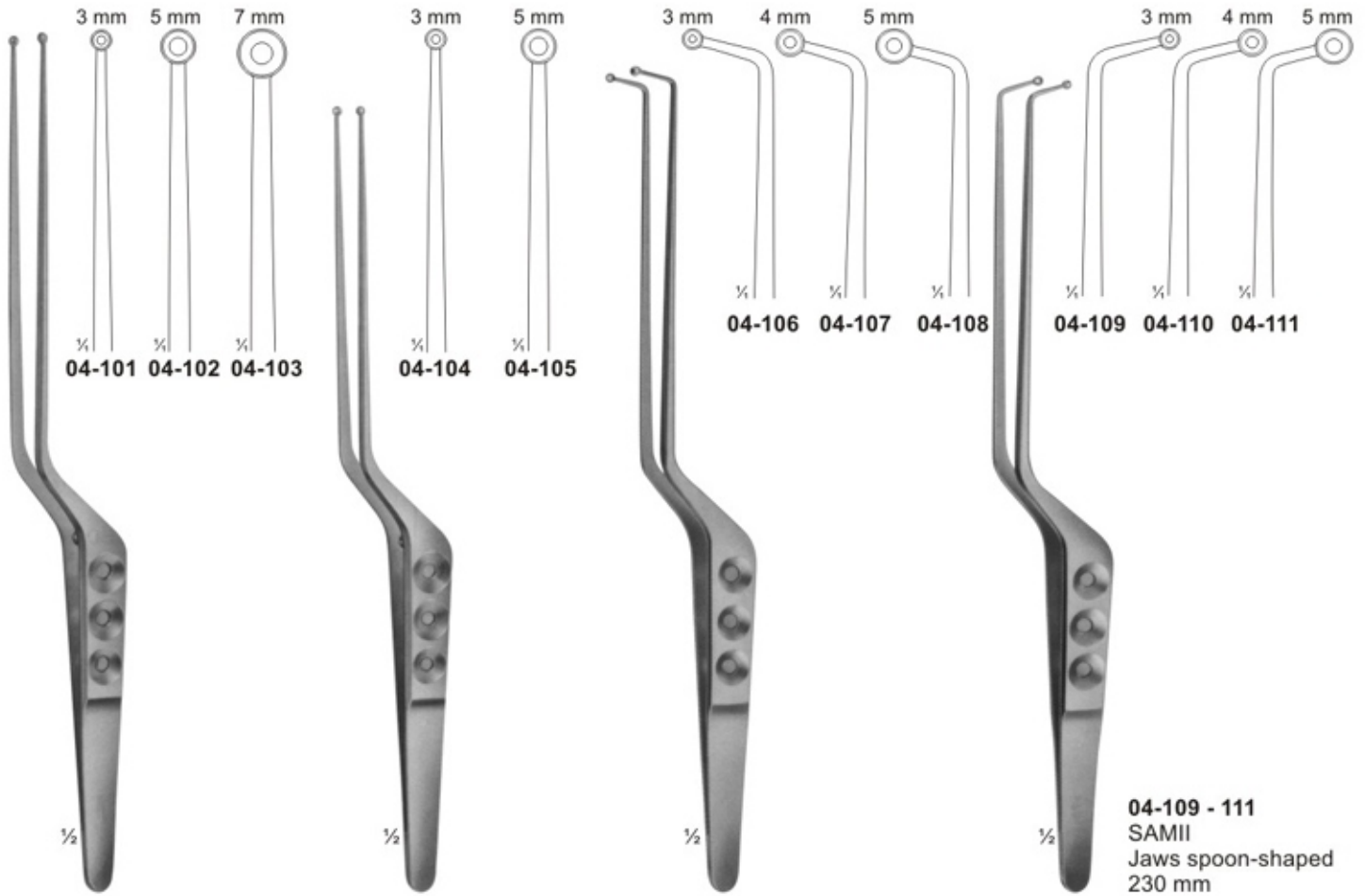

04-101 - 103
YASARGIL-SAMII
Jaws spoon-shaped
240 mm

04-104 - 105
YASARGIL
Jaws spoon-shaped
220 mm

04-106 - 108
SAMII
Jaws spoon-shaped
230 mm

04-109 - 111
SAMII
Jaws spoon-shaped
230 mm

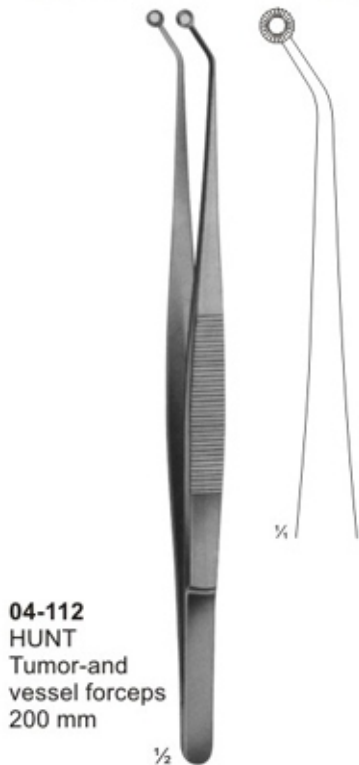

04-112
HUNT
Tumor-and
vessel forceps
200 mm



04-113
HUNT
Tumor-and
vessel forceps
200 mm

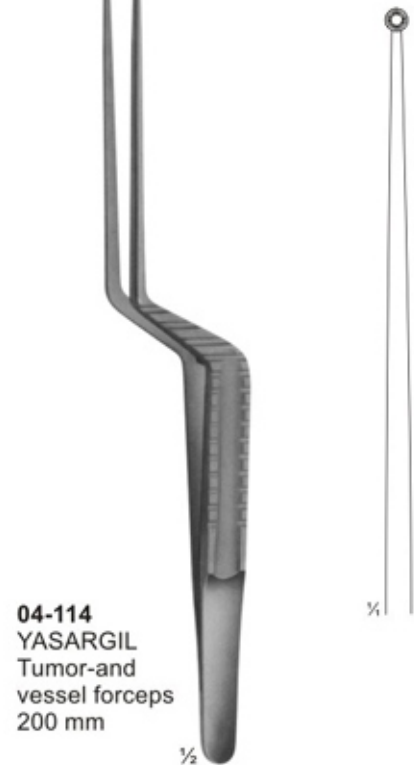

04-114
YASARGIL
Tumor-and
vessel forceps
200 mm

Delicate Dissecting, Microscopic, Sterilizing Forceps



04-115
THORPE
Corneal forceps
120 mm

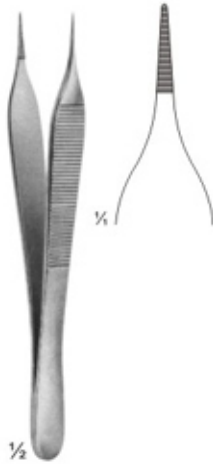

04-116
MICRO-ADSON
120 mm

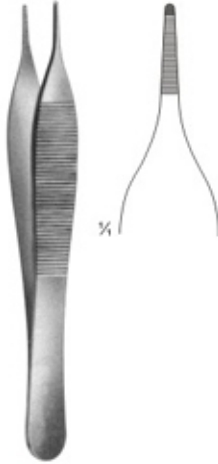

04-117
ADSON
120 mm



04-118
MICRO-ADSON
150 mm

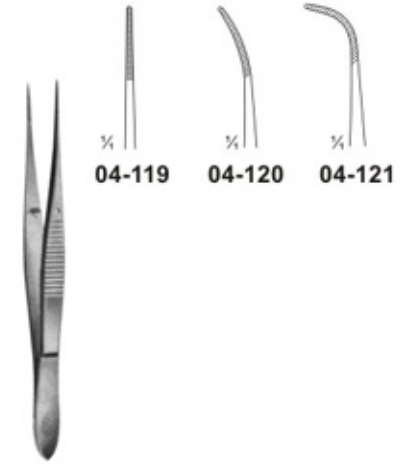

04-119 - 121
100 mm

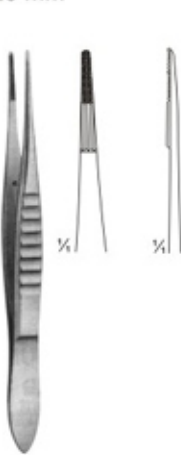

04-122
BONACCOLTO
110 mm

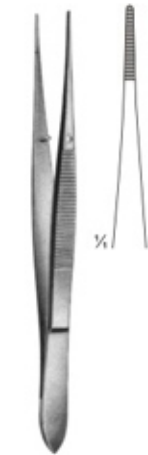

04-123
115 mm

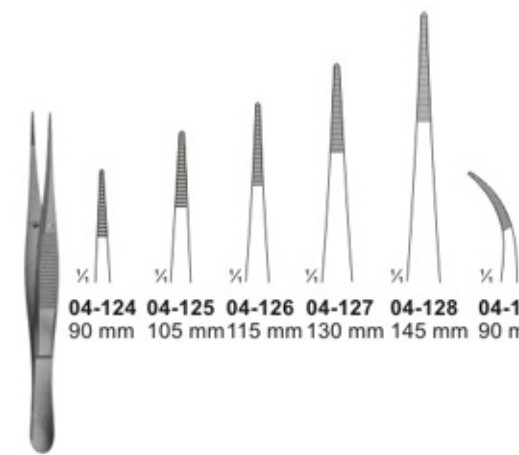

04-124 - 133

04-124 90 mm **04-125** 105 mm **04-126** 115 mm **04-127** 130 mm **04-128** 145 mm **04-129** 90 mm **04-130** 105 mm **04-131** 115 mm **04-132** 130 mm **04-133** 145 mm

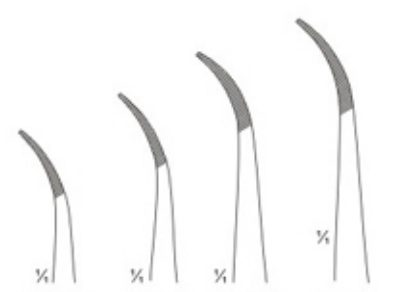

04-137
KUHNE
Cover glass forceps, 105 mm

04-138
160 mm



04-134
100 mm

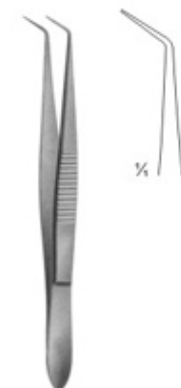

04-135
100 mm



04-136
100 mm

Delicate Dissecting Forceps

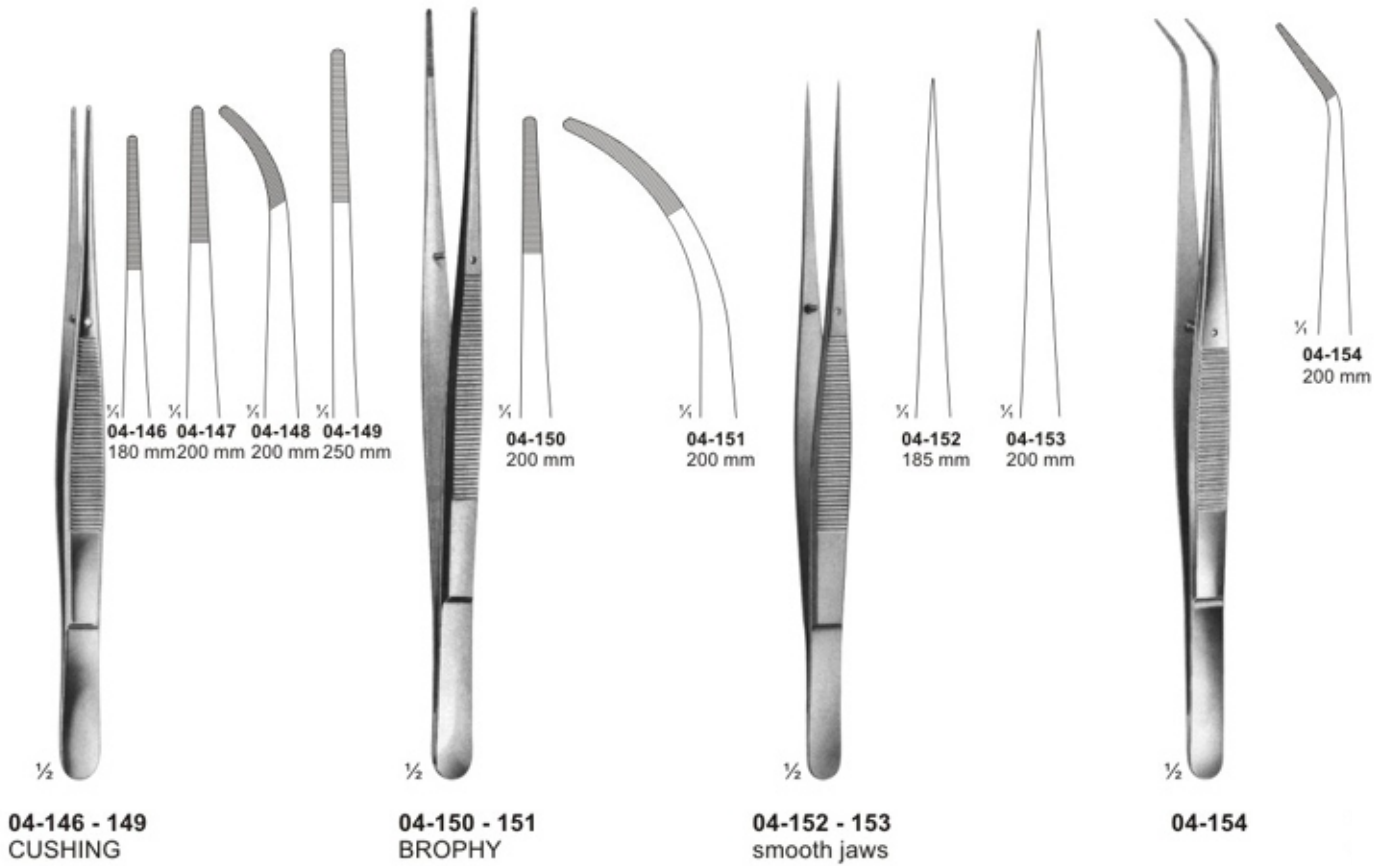
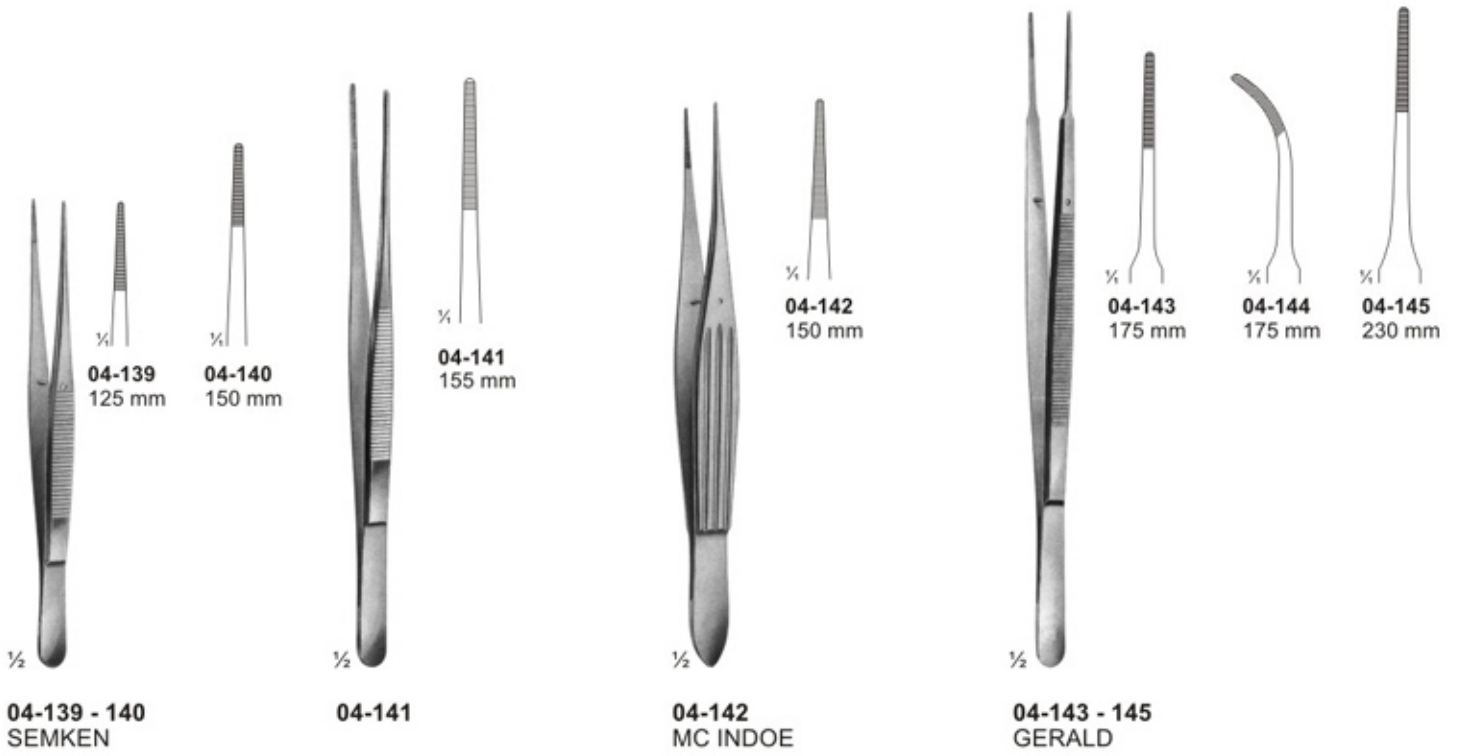

Dissecting Forceps

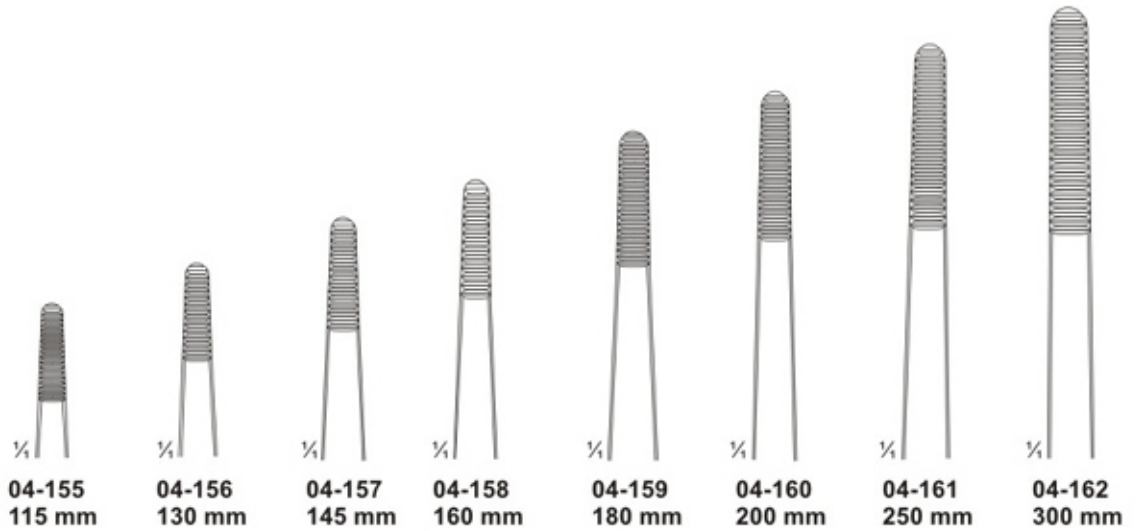

04-155 - 04-162
STANDARD

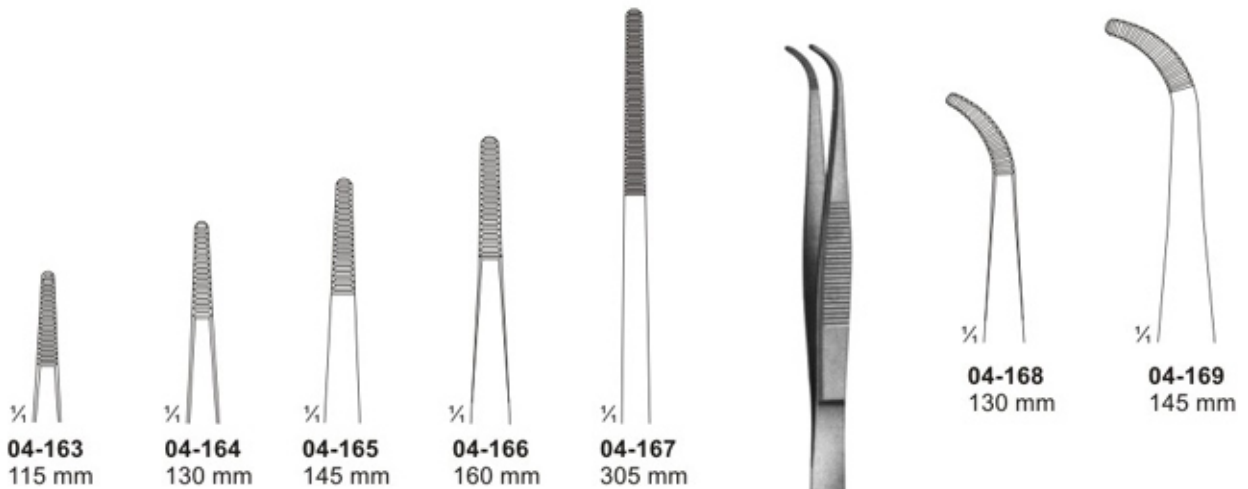

04-163 - 04-167
MEDIUM

04-168 - 04-169
MEDIUM

Forceps

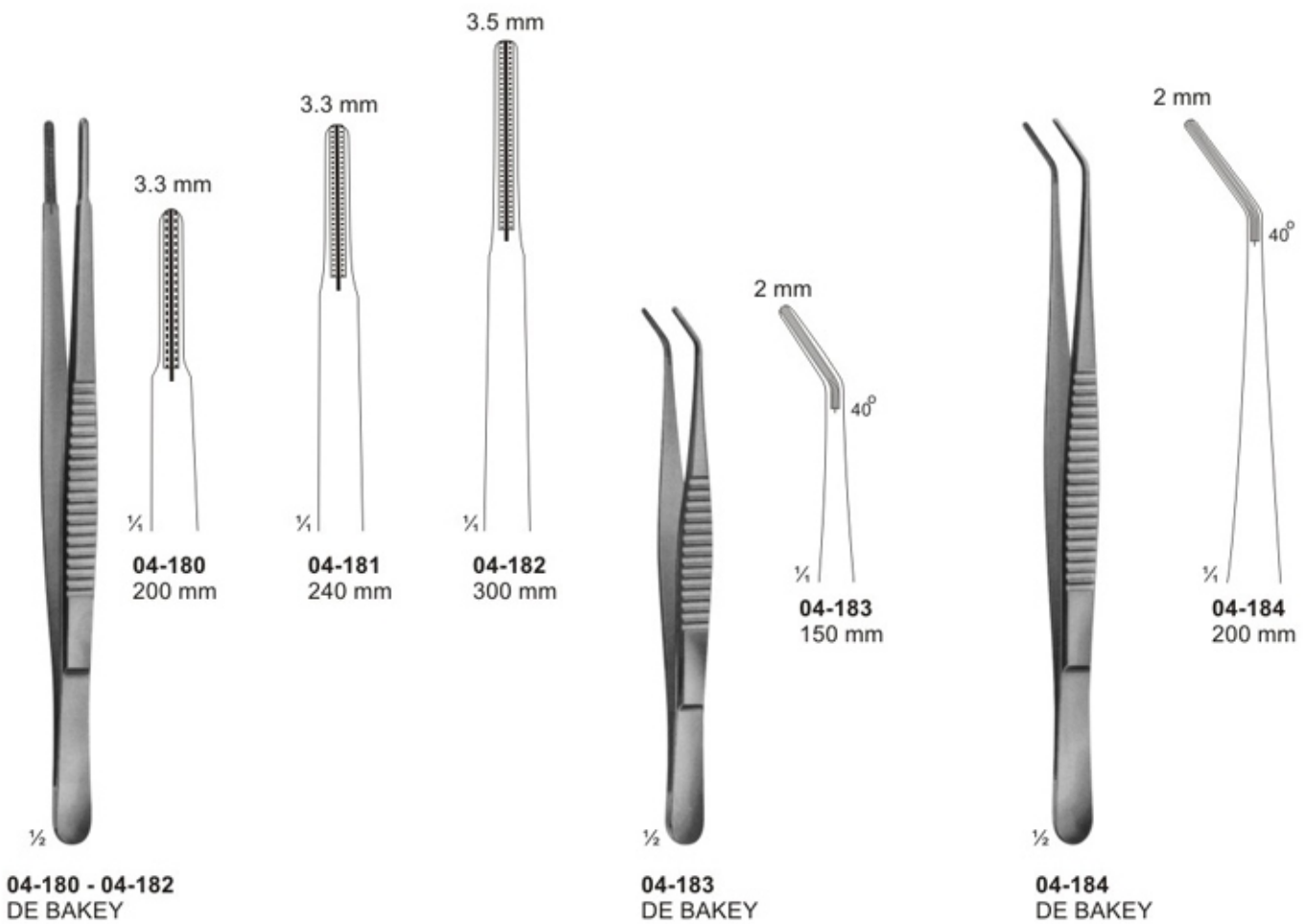
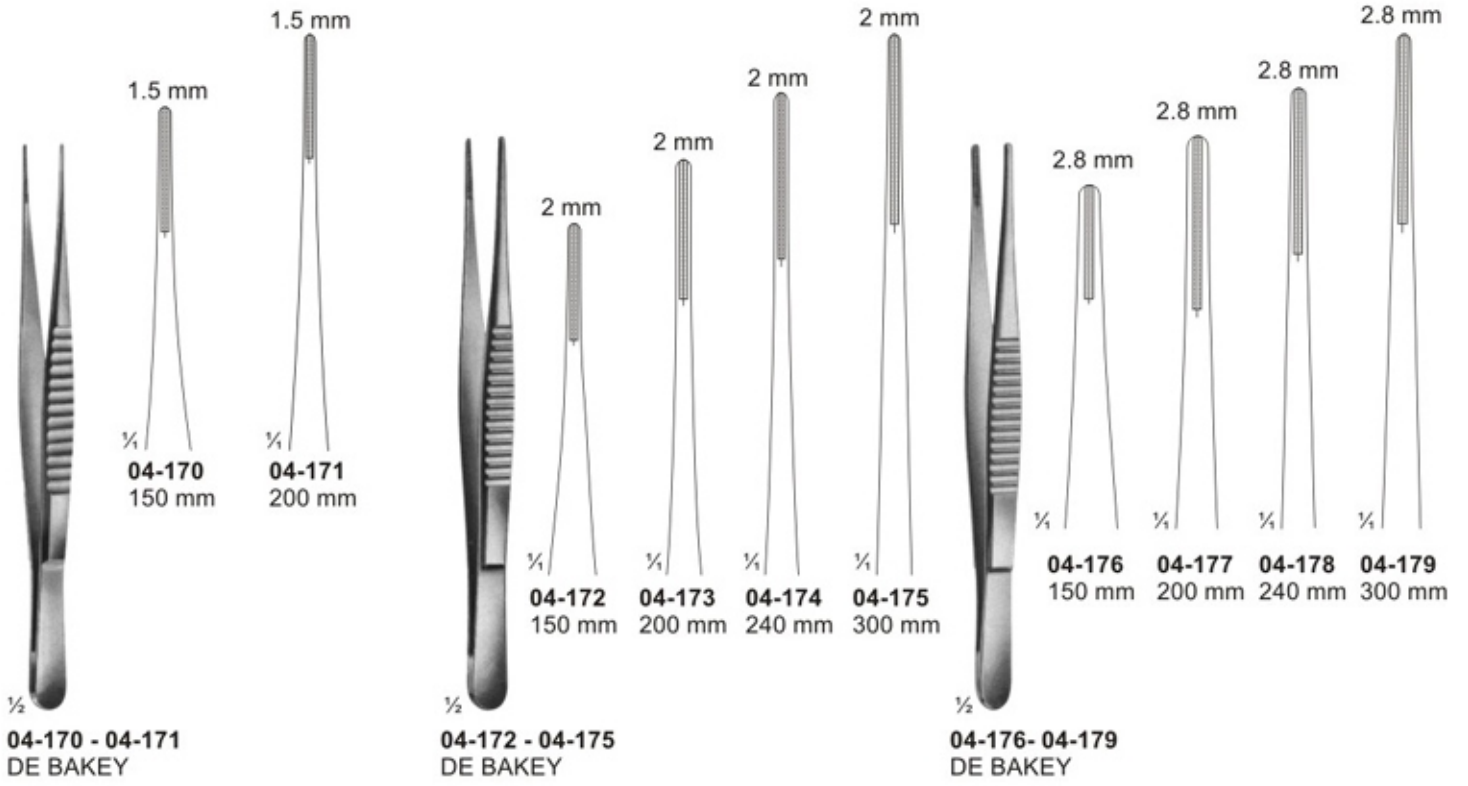

Delicate Tissue Forceps

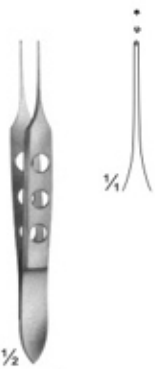

04-185
BISHOP-HARMON
85 mm

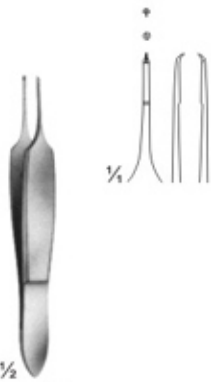

04-186
ST.MARTIN
80 mm

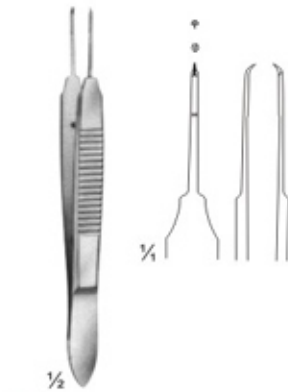

04-187
CASTROVIEJO
teeth 0.9 mm
100 mm

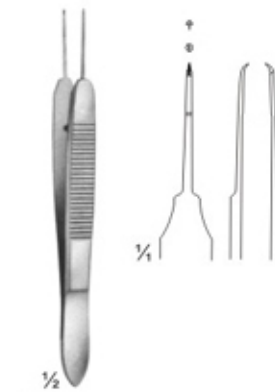

04-188
CASTROVIEJO
teeth 0.5 mm
100 mm

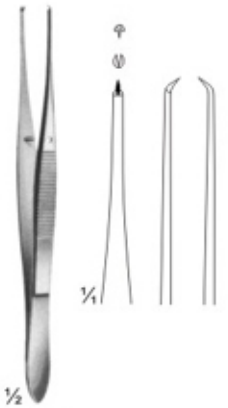

04-189
ELSCHING
110 mm

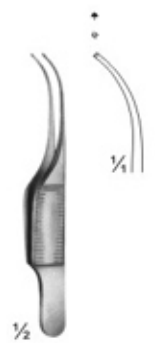

04-190
GILL
75 mm



04-191
GILL - HESS
75 mm

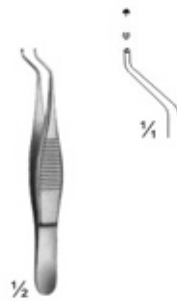

04-192
HESS
70 mm

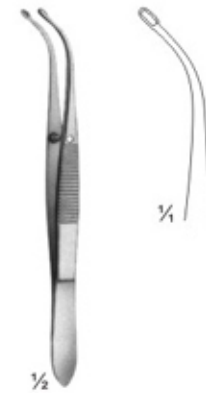

04-193
ARRUGA
100 mm

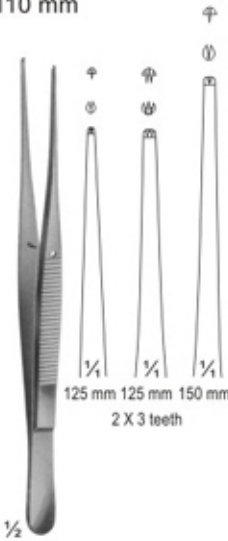

04-194
SEMKEN
125 mm
125 mm
150 mm
2 X 3 teeth

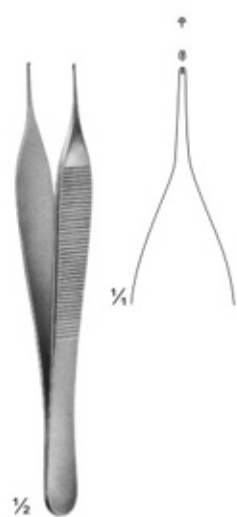

04-195
MICRO-ADSON
120 mm

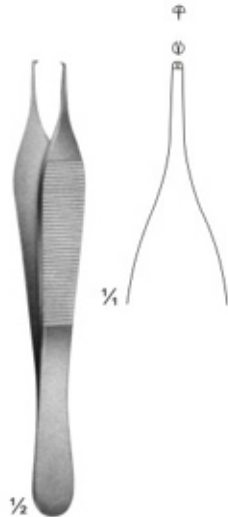

04-196
ADSON
120 mm



04-197
ADSON
120 mm

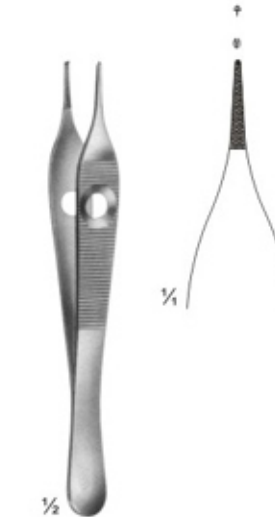

04-198
ADSON
120 mm

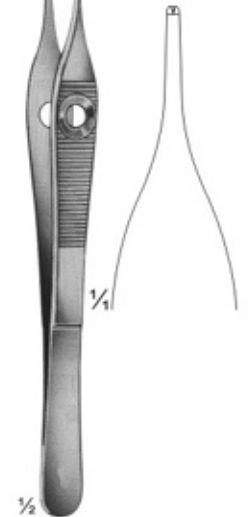

04-199
ADSON
150 mm

Tissue Forceps

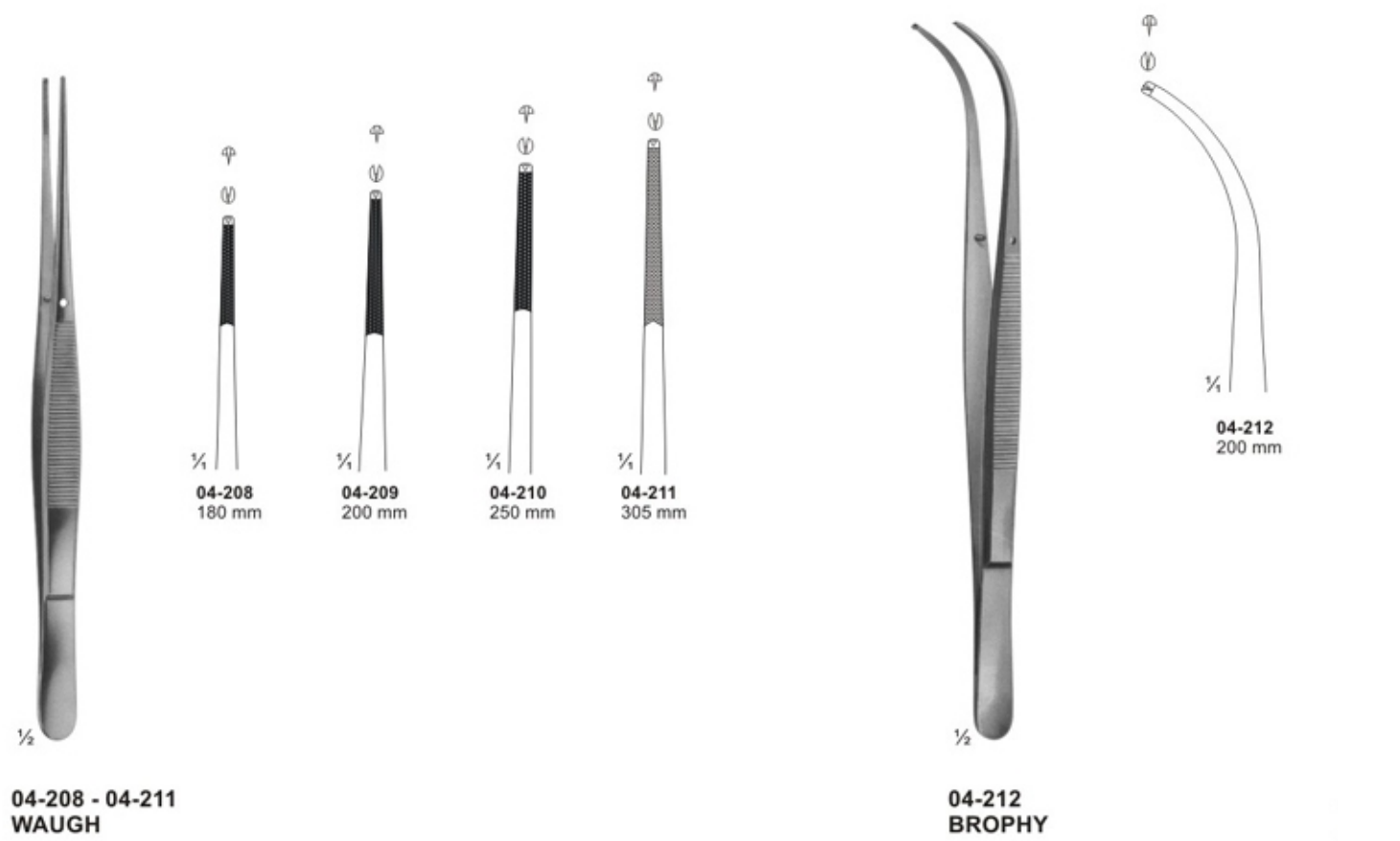
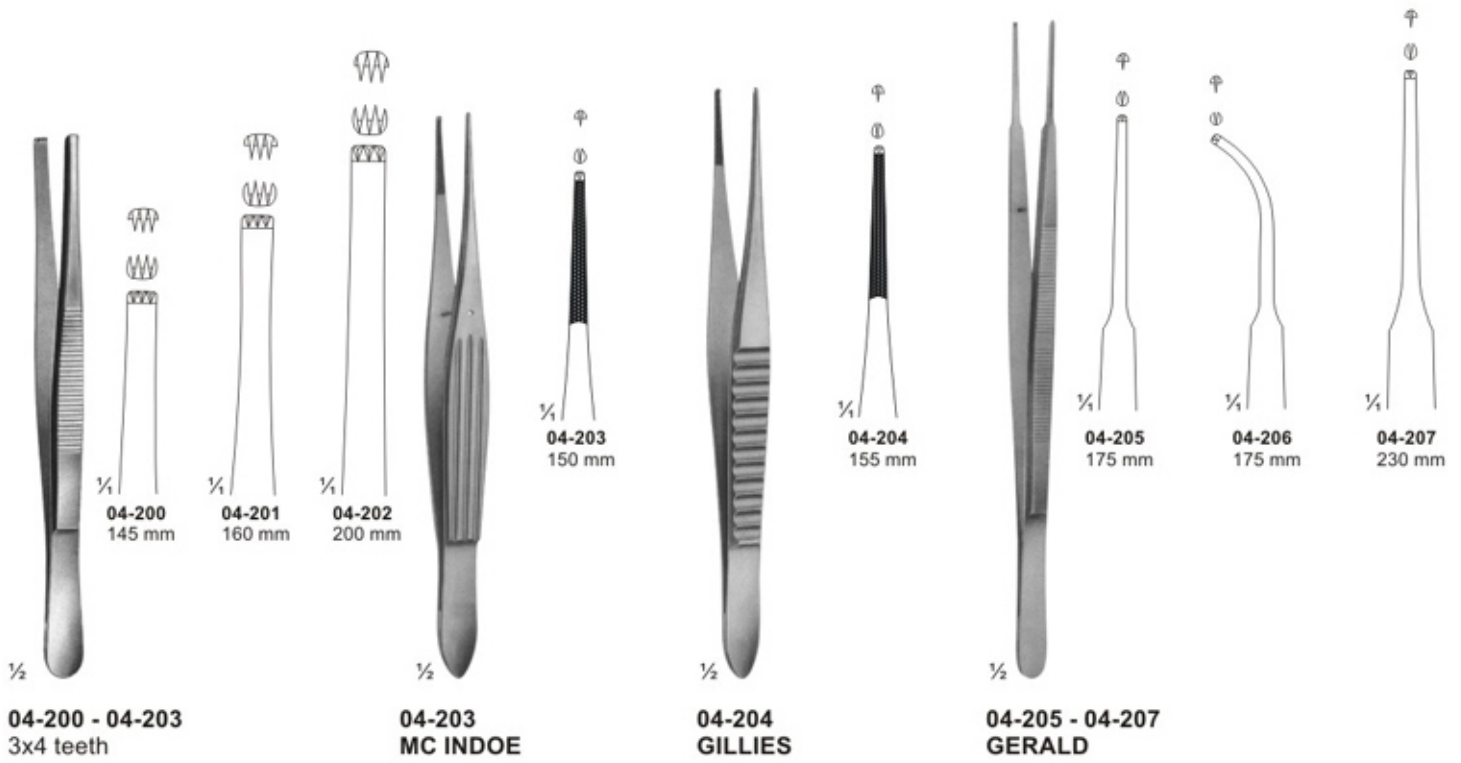

Tissue Forceps

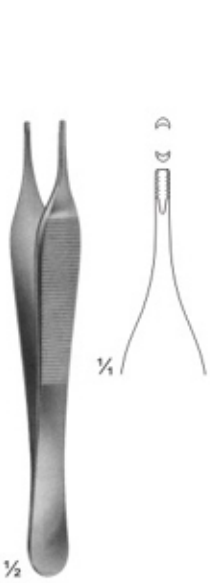

04-213
ADSON - BROWN
Non-traumatic
120 mm

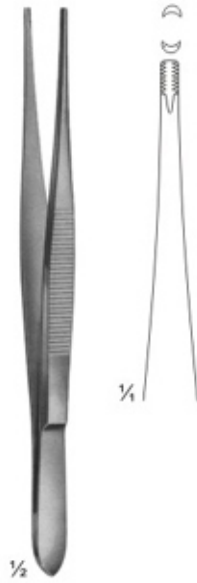

04-214
BROWN
120 mm



04-215
GRAEFE
110 mm

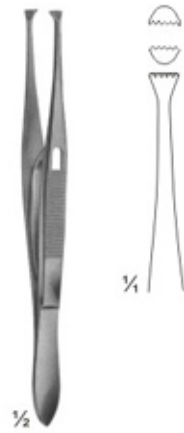

04-216
GRAEFE
With Catch
110 mm

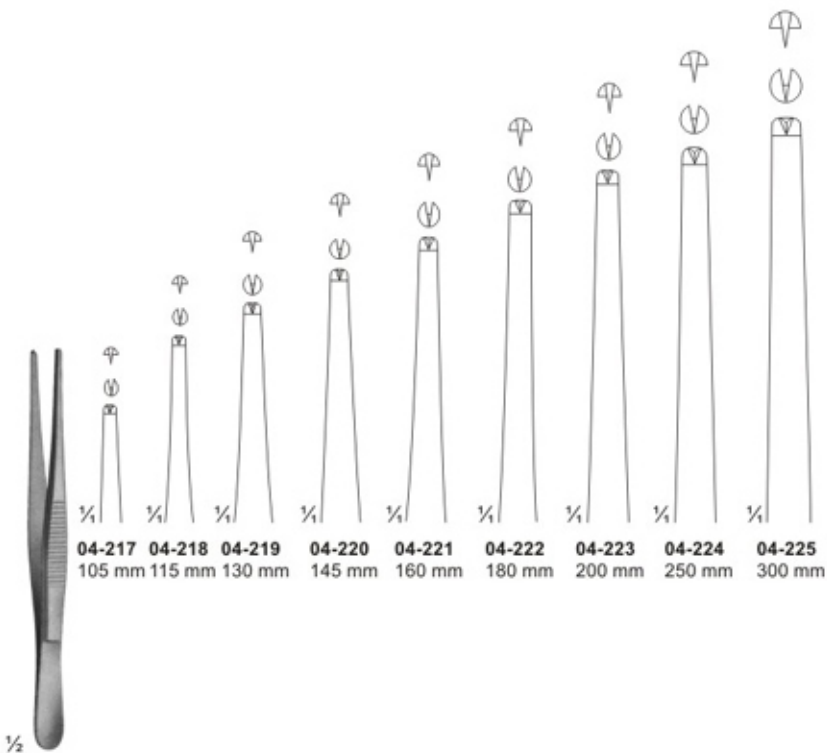

04-217 - 04-225
STANDARD

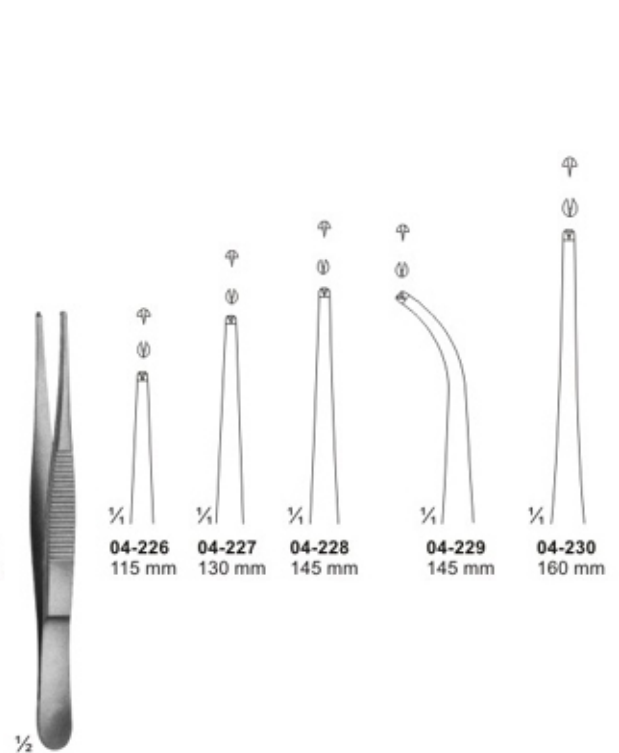

04-226 - 04-230
GRAEFE
110 mm

Forceps, Bayonet - Shaped

INSTRUMENTS Co.



04-231
LUCAE
140 mm



04-232
LUCAE
1x2 teeth
140 mm



04-233
COTTLE
Forceps with
jaws toothed
and serrated
140 mm



04-234
JANSEN
160 mm

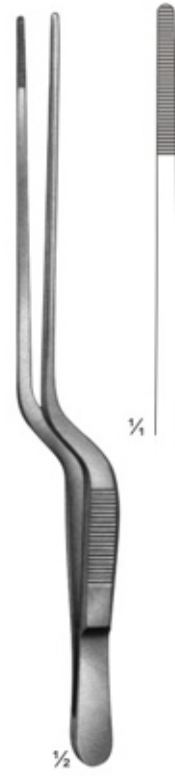

04-235
GRUENWALD
200 mm



04-236
1x2 teeth
200 mm



04-237
TROELTSCH
100 mm

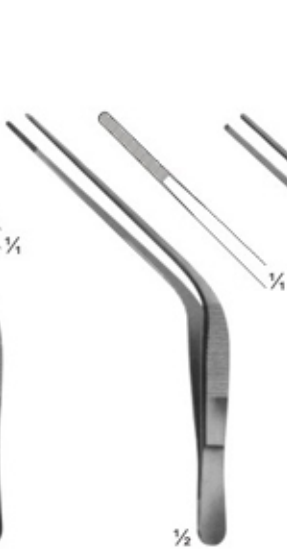

04-238
TROELTSCH
115 mm

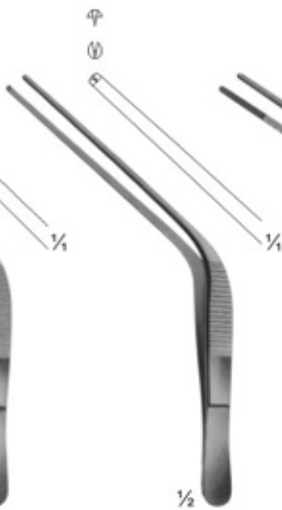

04-239
TROELTSCH
1X2 teeth
115 mm

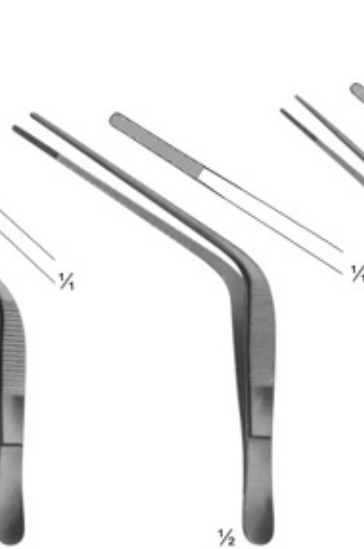

04-240
WILDE
115 mm

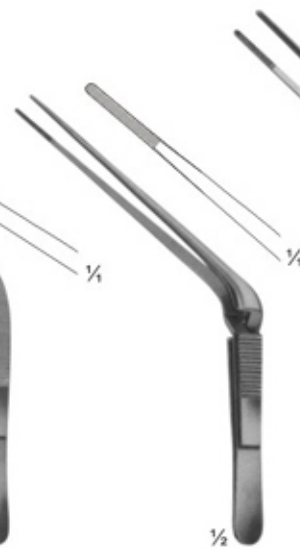

04-241
TROELTSCH
Cross action
120 mm

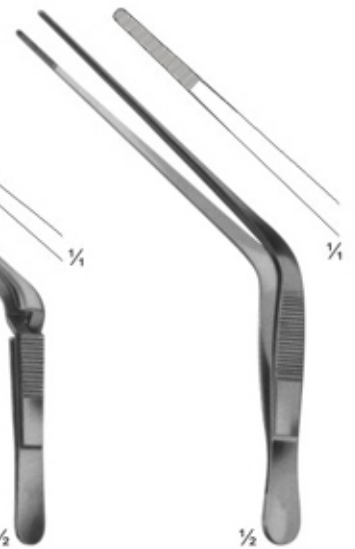

04-242
TROELTSCH
140 mm

Tissue Forceps, Lung Dissecting Forceps

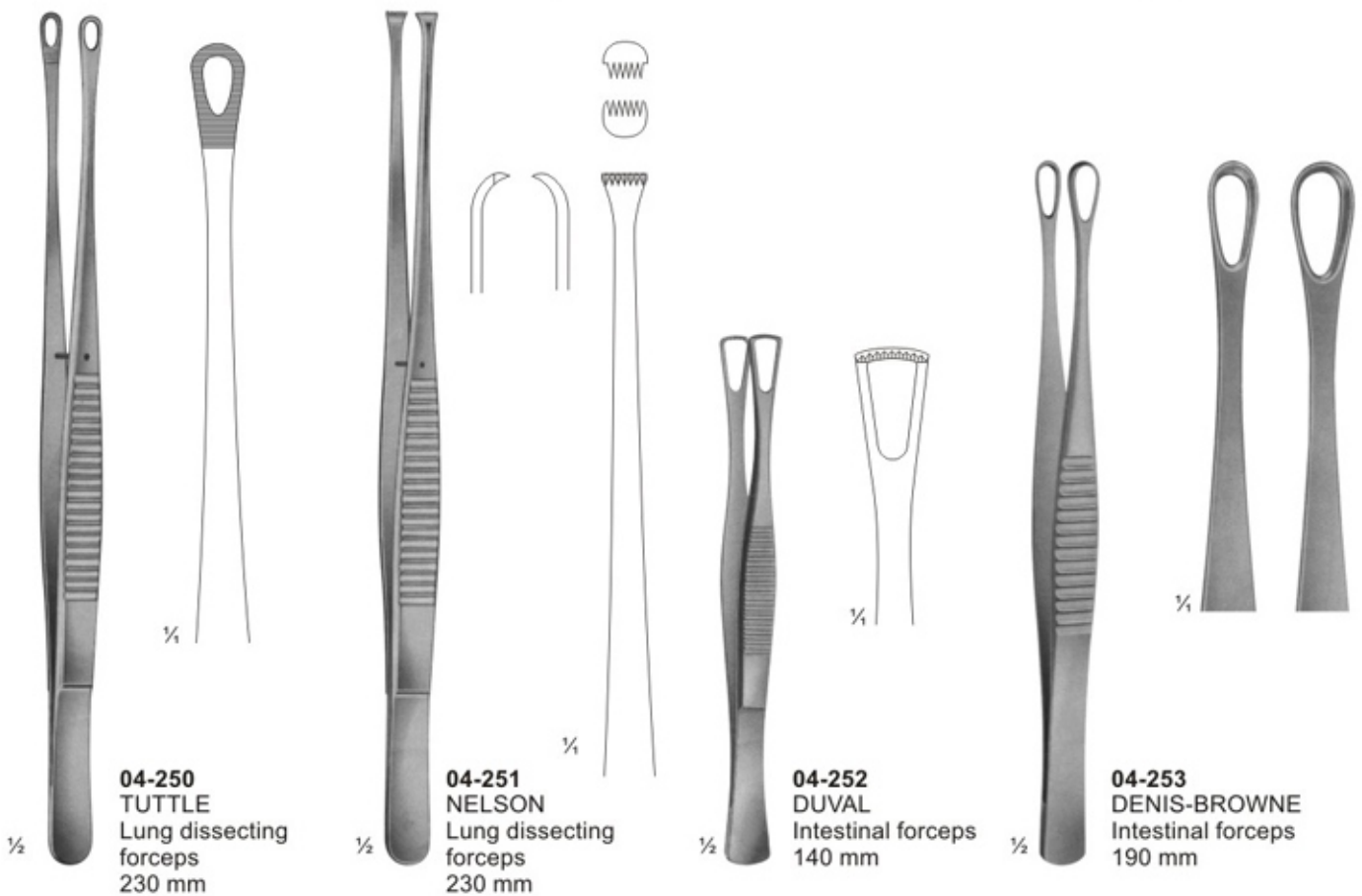
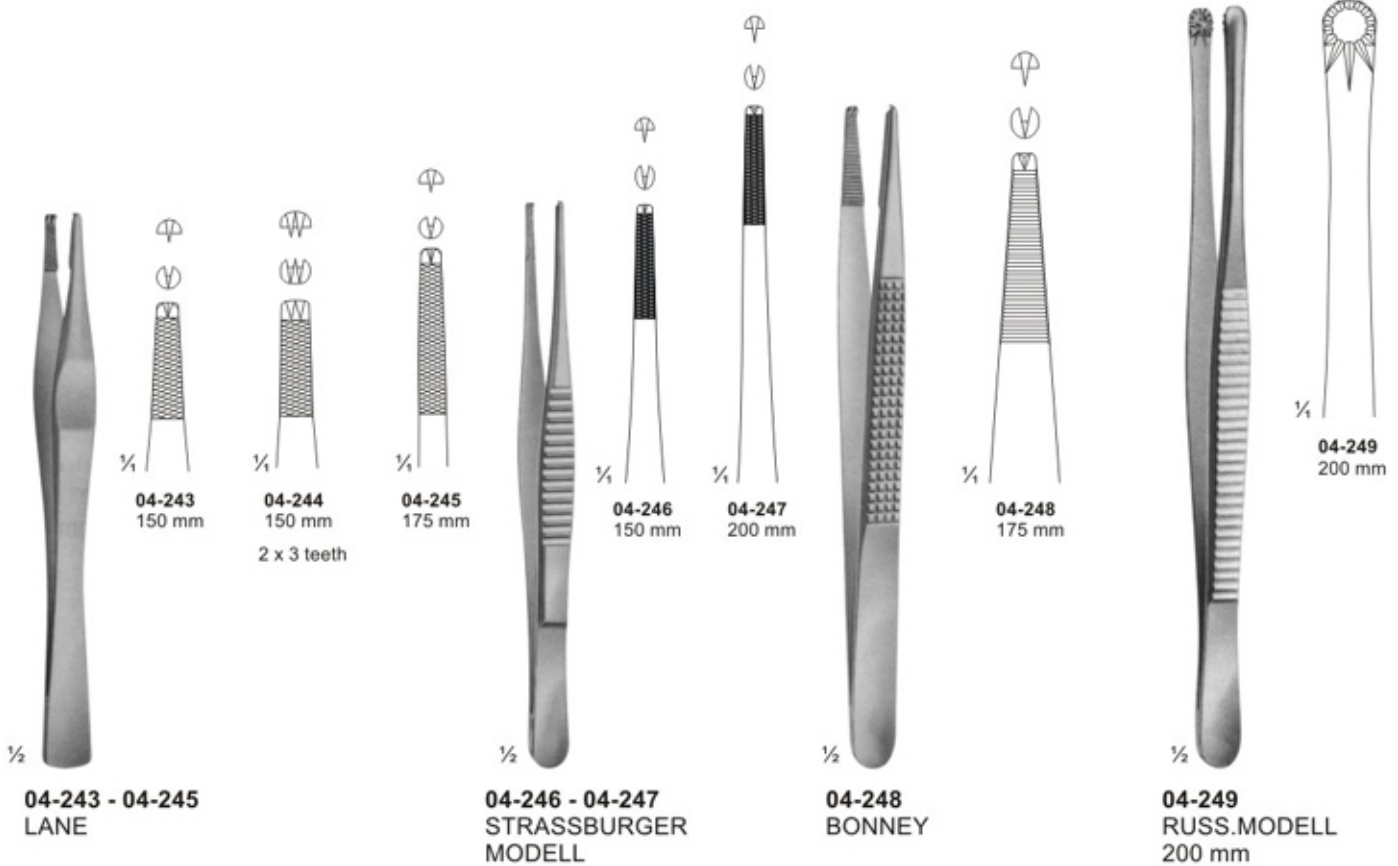

Splinter and Cilia Forceps

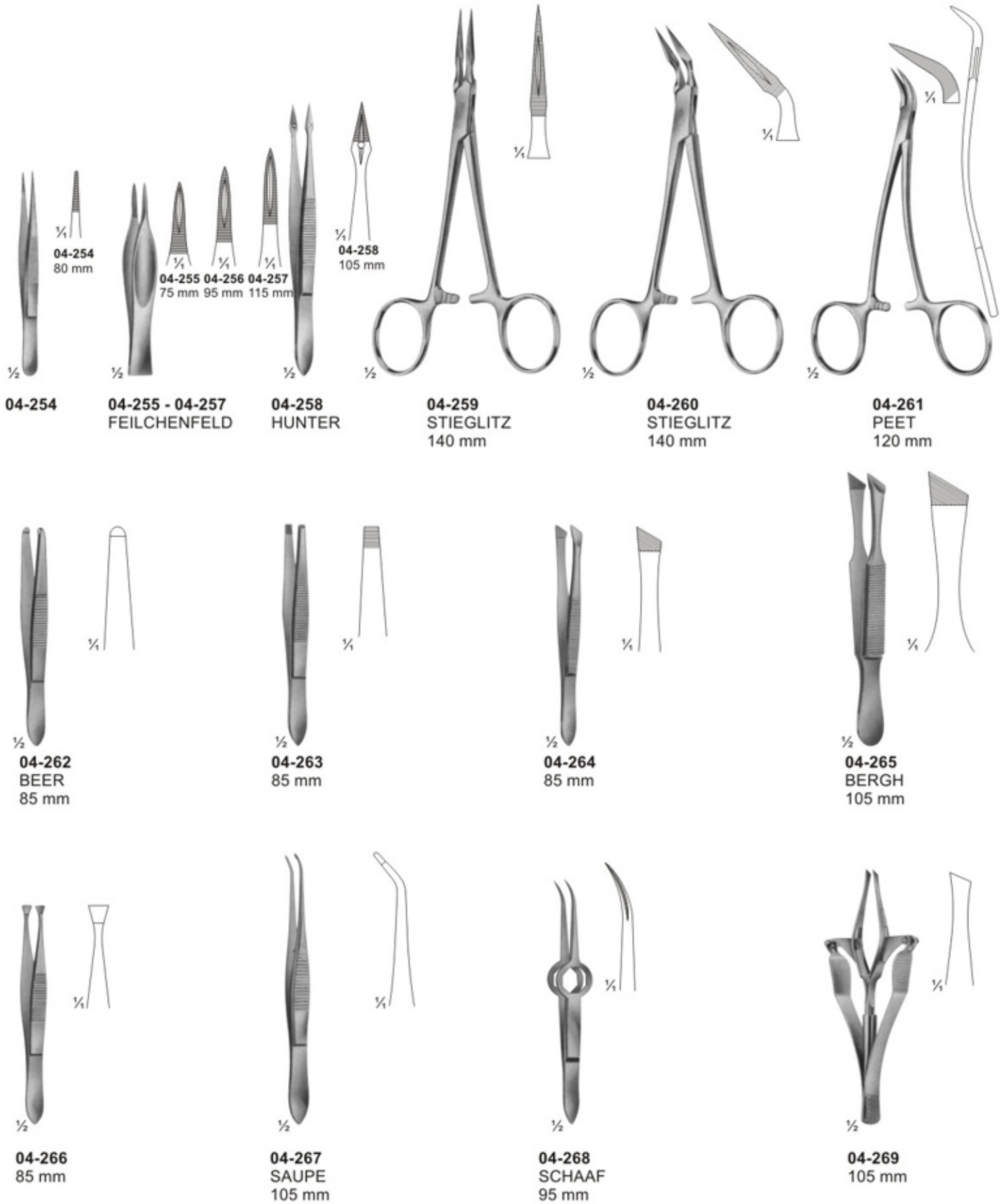

Sponge and Dressing Forceps

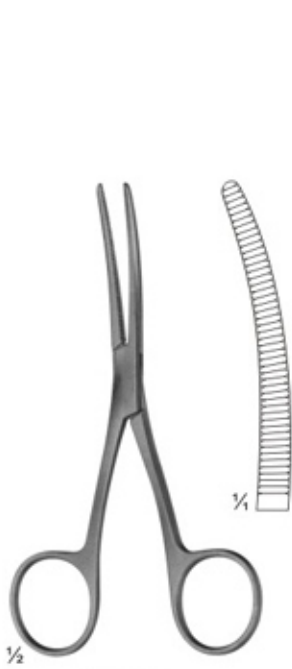

04-270
BRYANT
130 mm



04-271 - 04-273
LISTER
Sinus forceps

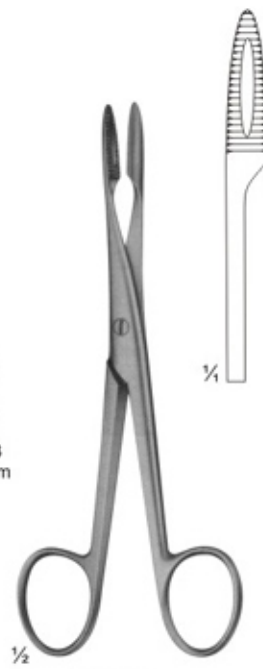

04-274
without ratchet
145 mm

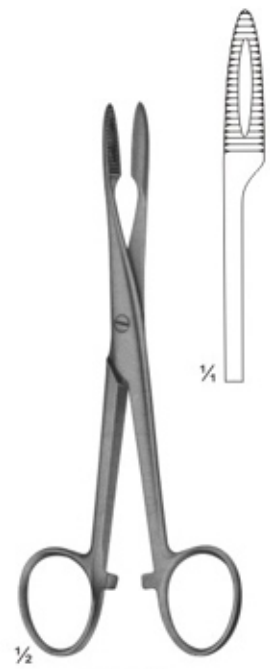

04-275
with ratchet
145 mm

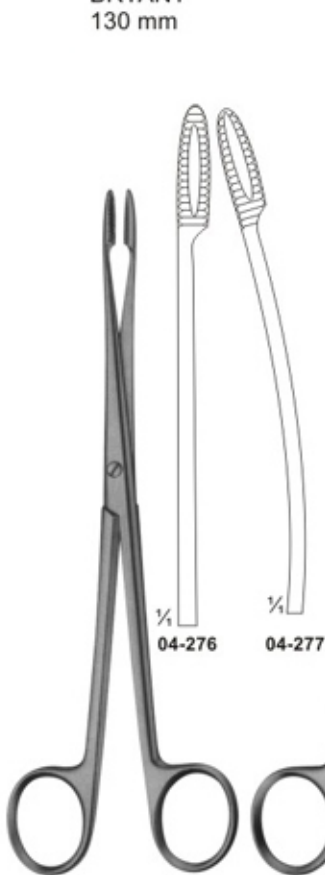

04-276 - 04-277
GROSS
without ratchet
180 mm

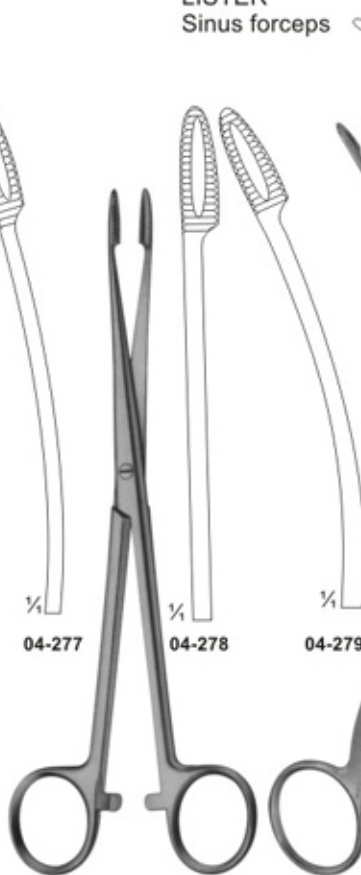

04-278 - 04-279
GROSS
with ratchet
180 mm

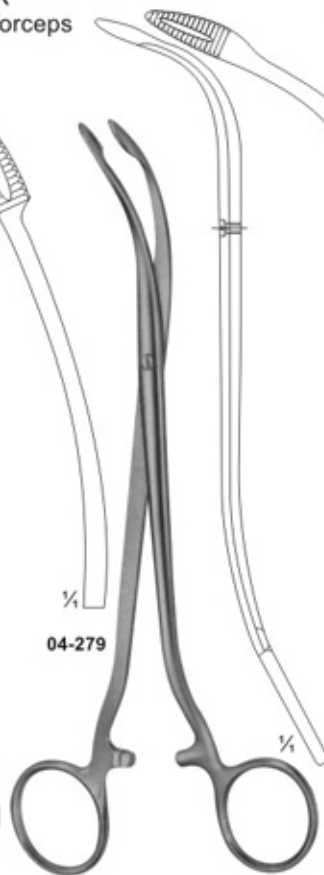

04-280
DUPLAY
190 mm

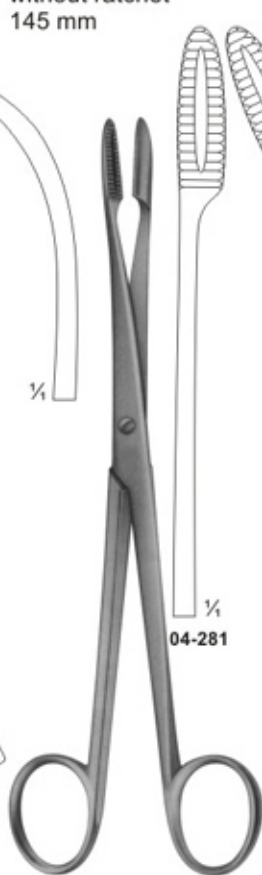

04-281 - 04-282
GROSS
without ratchet
200 mm

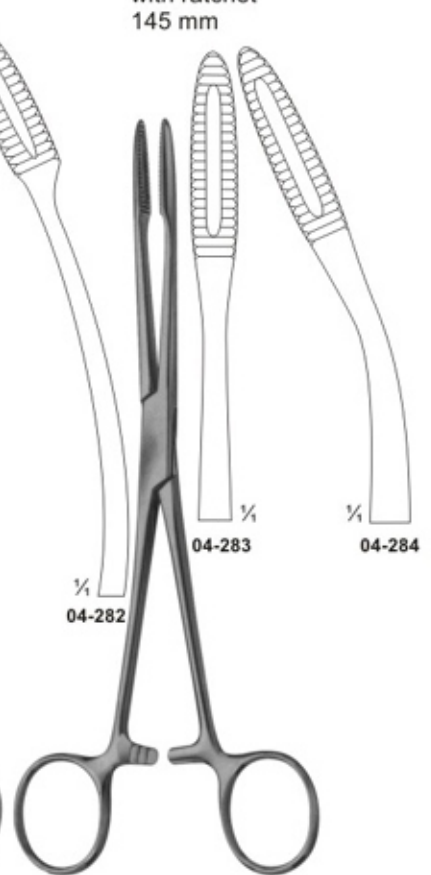

04-283 - 04-284
GROSS
200 mm

Dressing-, Sponge holding-, Organ- and Tissue Grasping Forceps

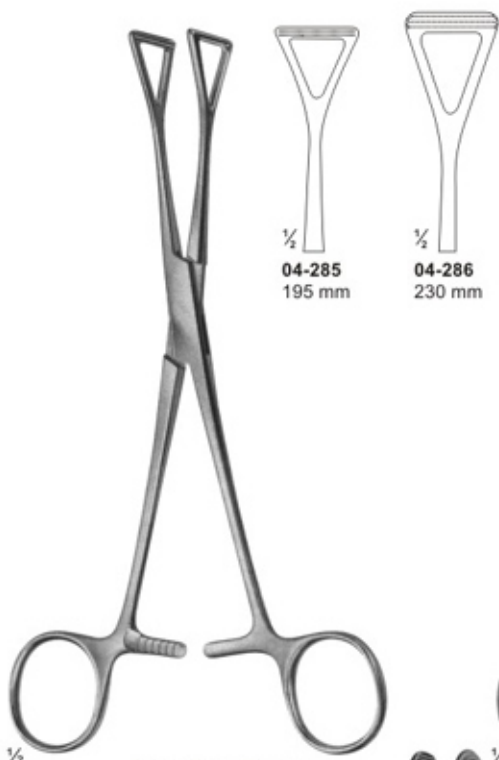

1/2
04-285
195 mm

1/2
04-286
230 mm

04-285 - 04-286
COLLIN



1/2
04-287
160 mm

1/2
04-288
160 mm

1/2
04-289
170 mm

04-287 - 04-289
COLLIN

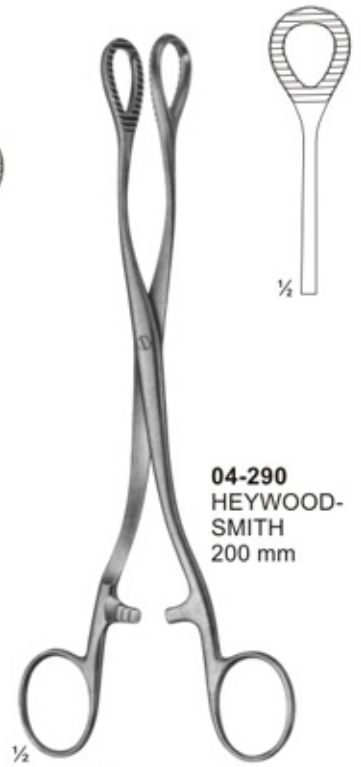

04-290
HEYWOOD-SMITH
200 mm



1/2
04-291
NOTO
280 mm

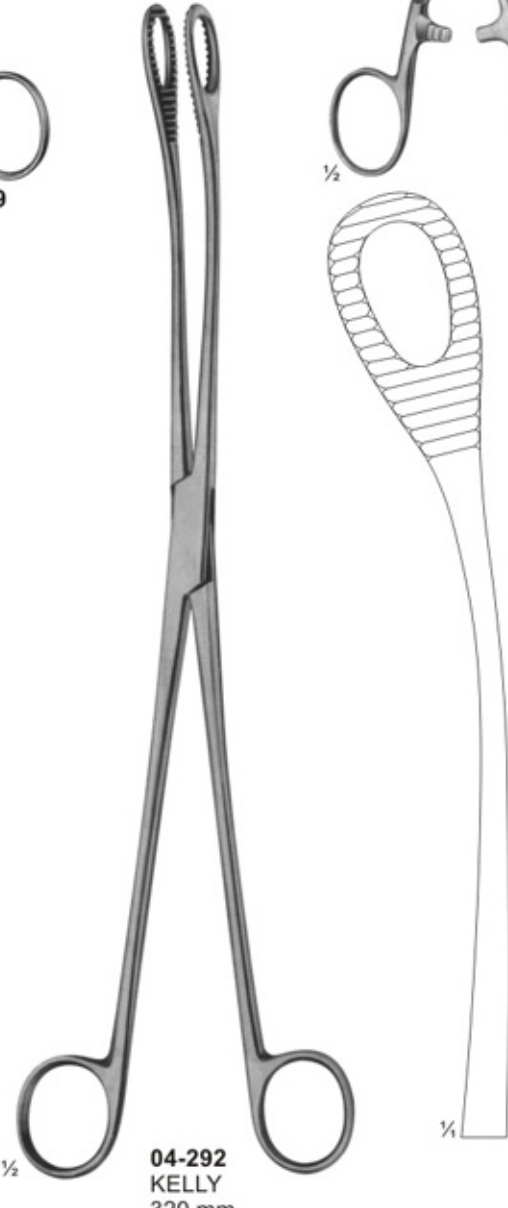

1/2
04-292
KELLY
320 mm

Dressing, Sponge holding, Organ and Tissue Grasping Forceps

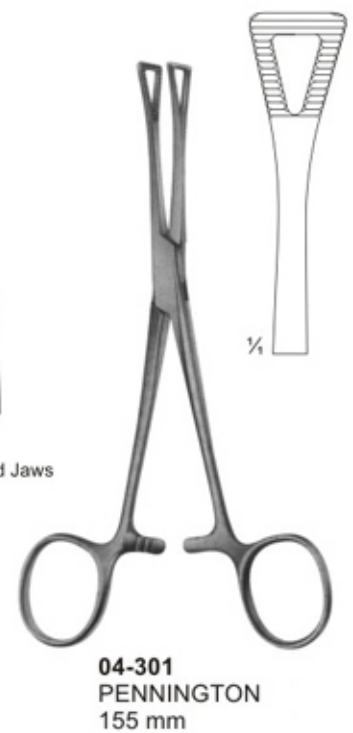
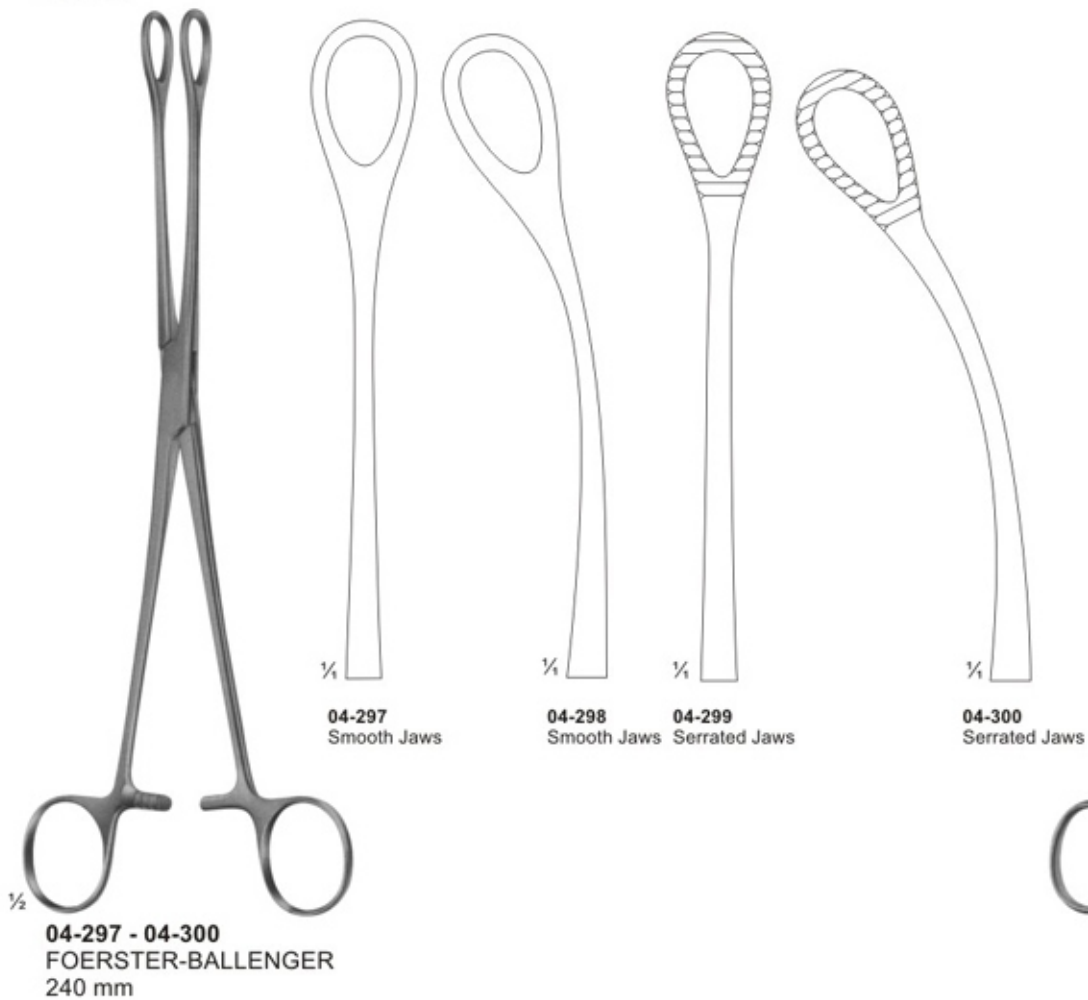
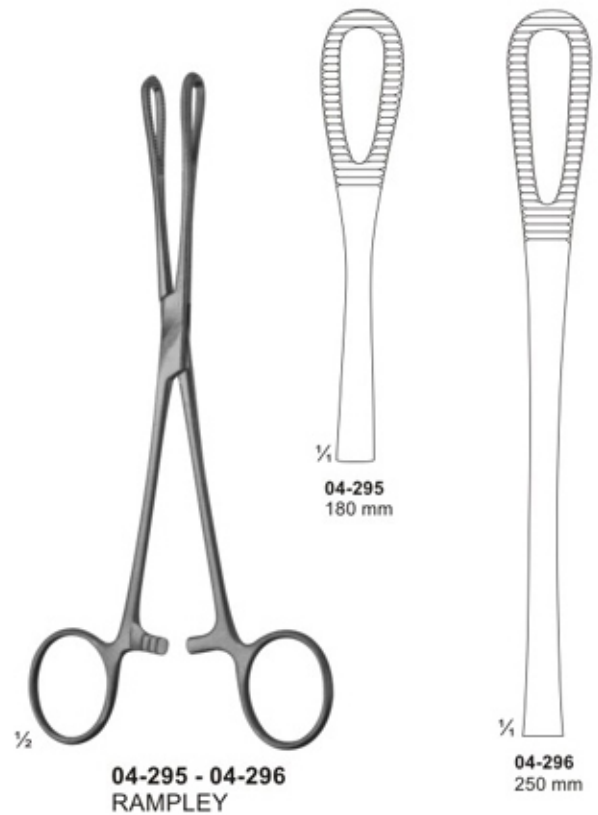
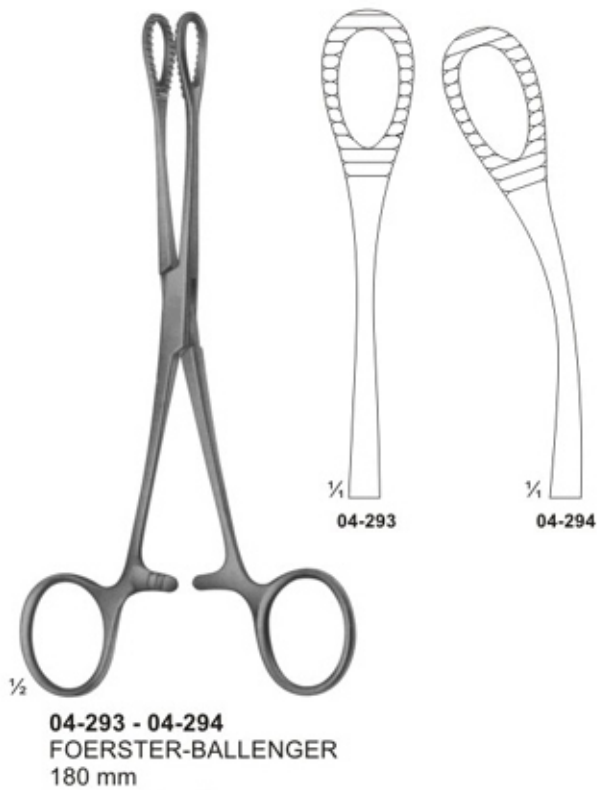

Intestinal Grasping Forceps

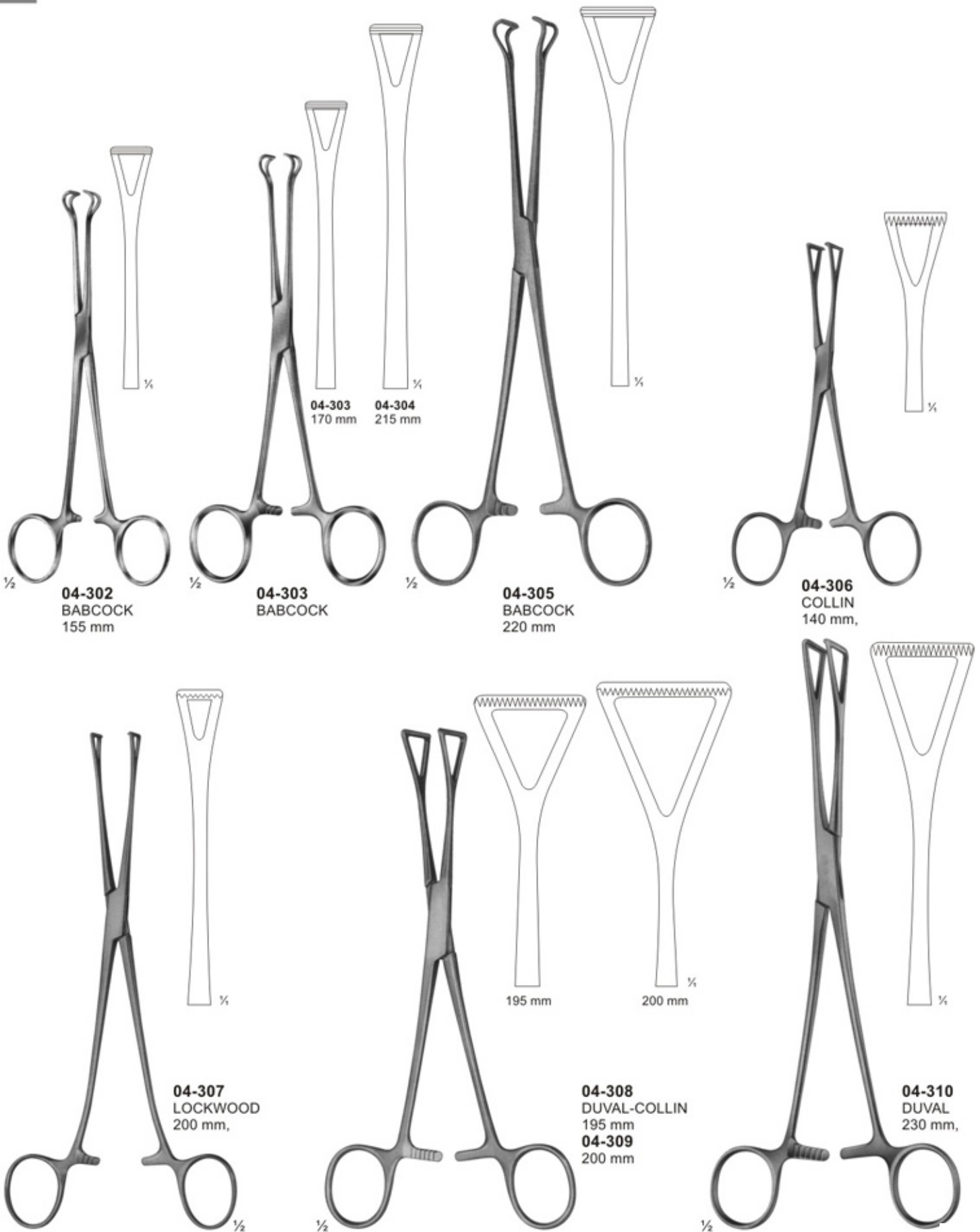

Artery Traction - and Tissue Grasping Forceps

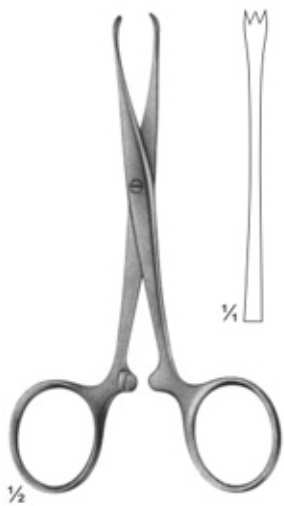

04-311
CHAPUT
 2 x 3 teeth
 125 mm

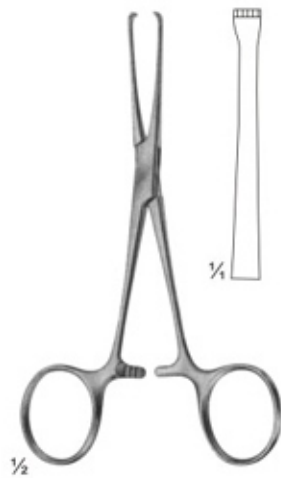

04-312
BABY-ALLIS
 4 x 5 teeth
 130 mm

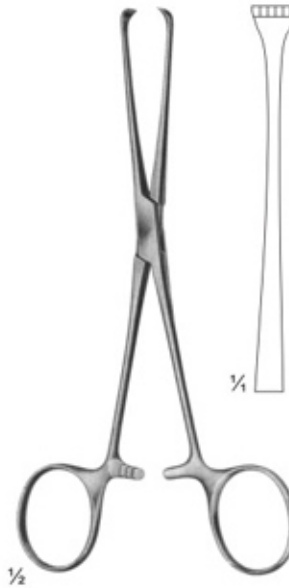

04-313
BOYS-ALLIS
 5 x 6 teeth sharp
 155 mm

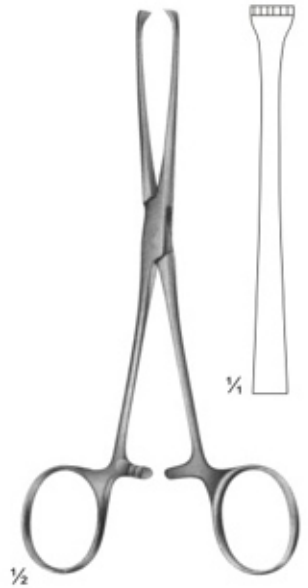

04-314
ALLIS
 5 x 6 teeth
 155 mm



04-315
LAHEY
 155 mm

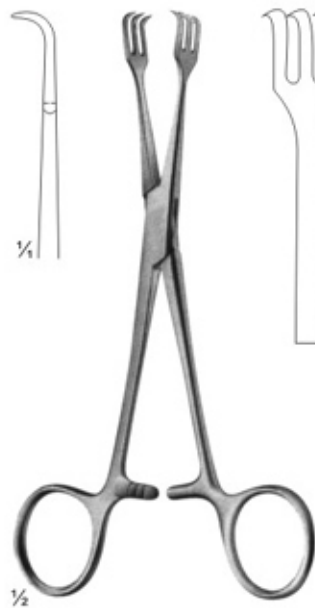

04-316
LAHEY
 155 mm

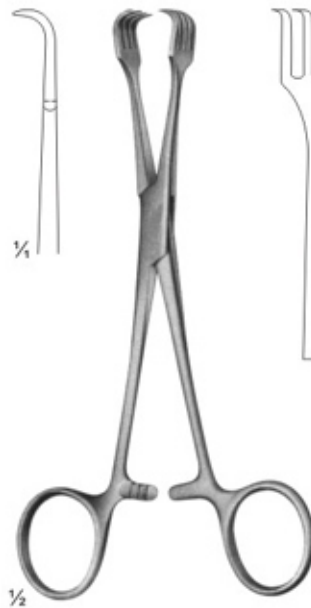

04-317
BRAUN
 155 mm

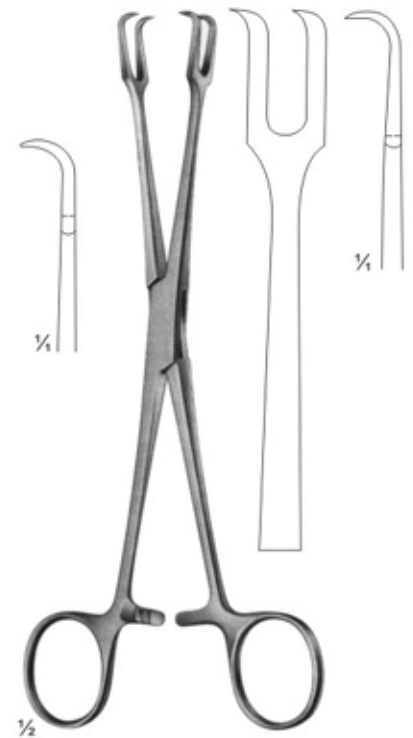

04-318
MUSEUX
 200 mm

Towel Clamps

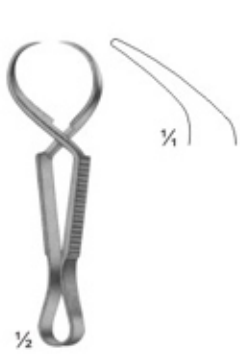

04-319
JONES
85 mm



04-320
ENGL. MOD.
85 mm

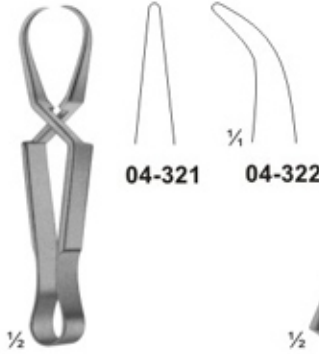

04-321 - 04-322
SCHAEDEL
85 mm



04-323
DOYEN
110 mm



04-324
DOYEN
180 mm

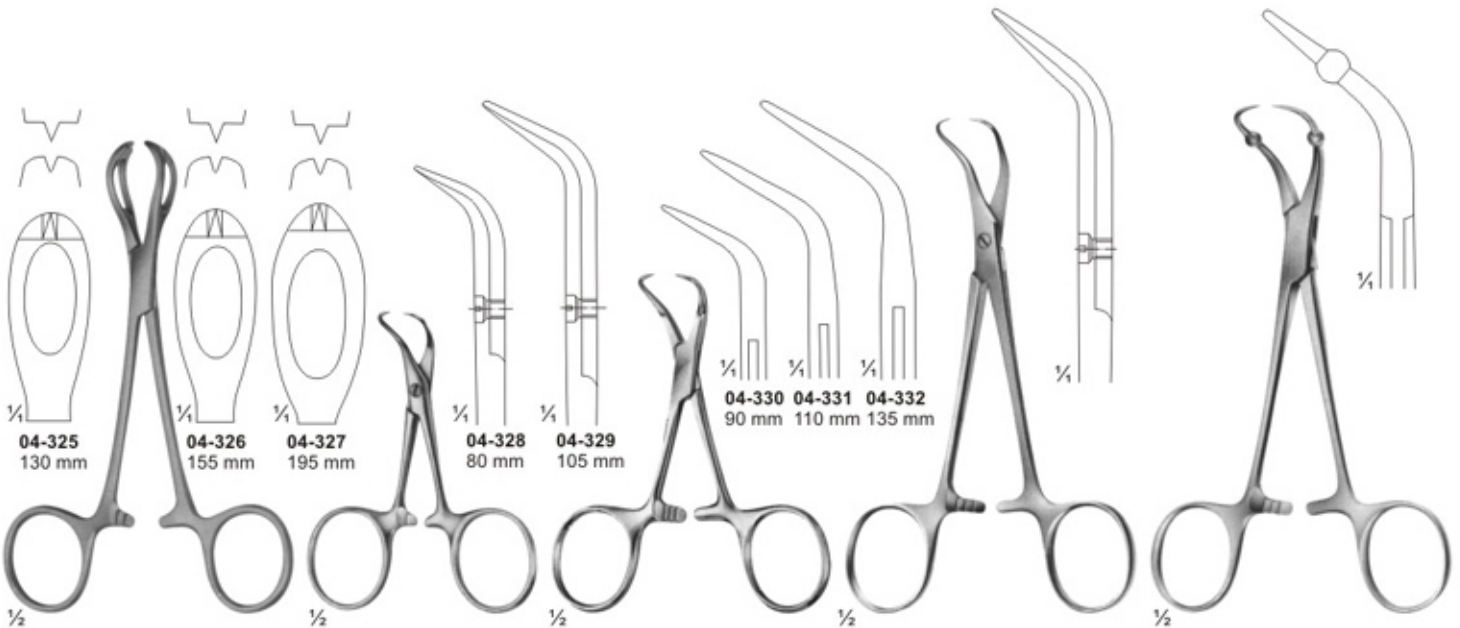

04-325 - 04-327
LANE

04-328 - 04-329
BACKHAUS

04-330 - 04-332
BACKHAUS

04-333
BACKHAUS-KOCHER
135 mm

04-334
ROEDER
135 mm

Muller Vessel Clips and Bulldog Clamps

Closing force

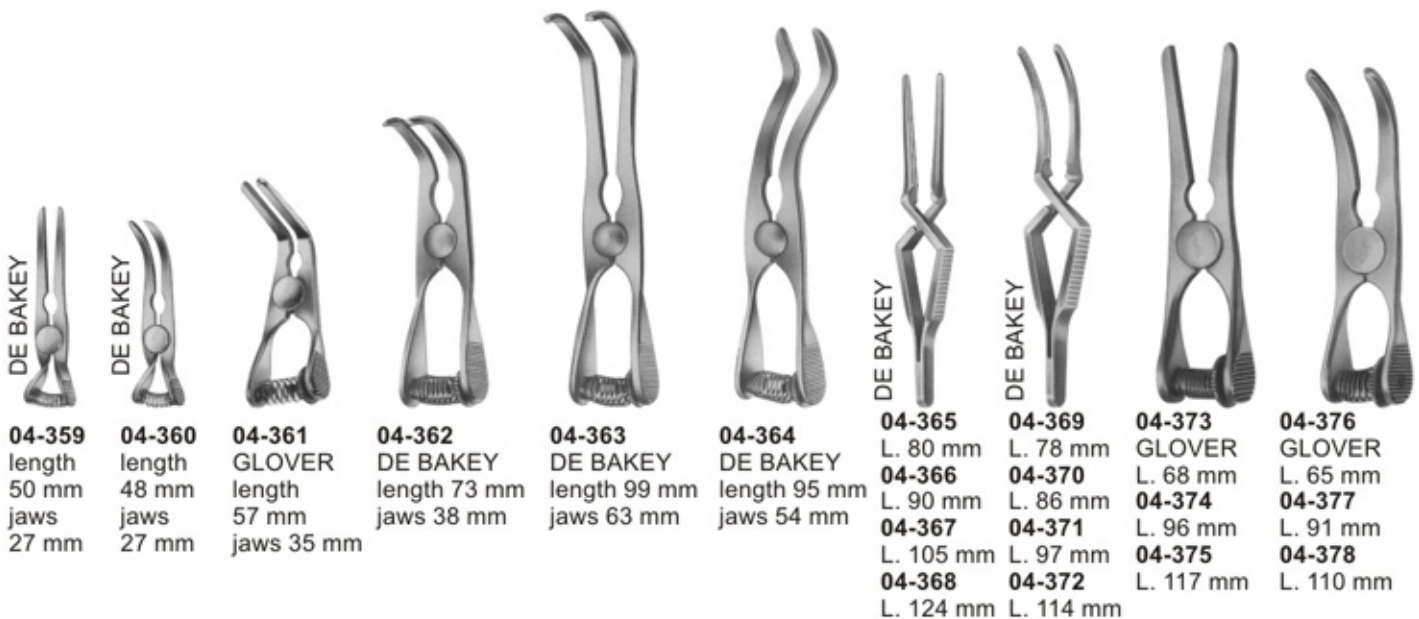
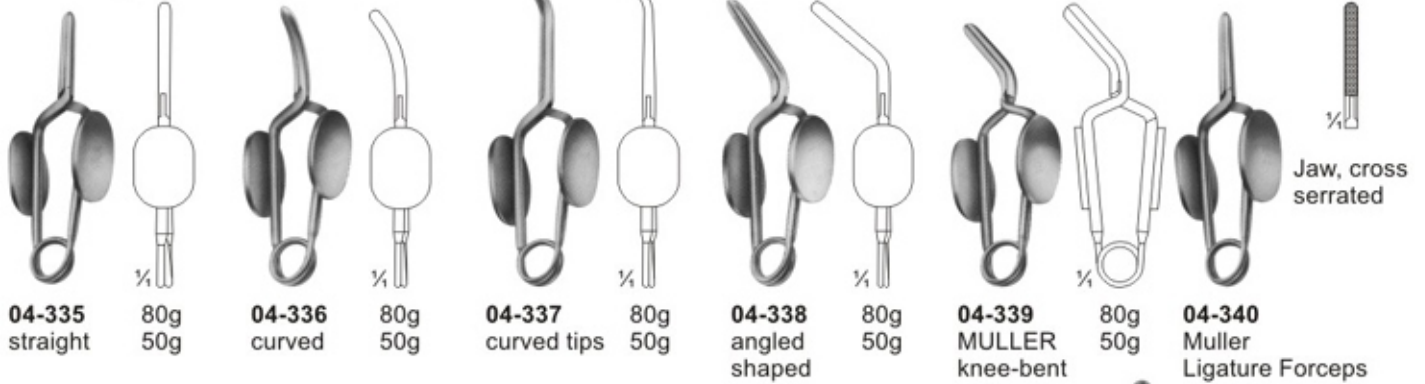

Delicate Haemostatic Forceps

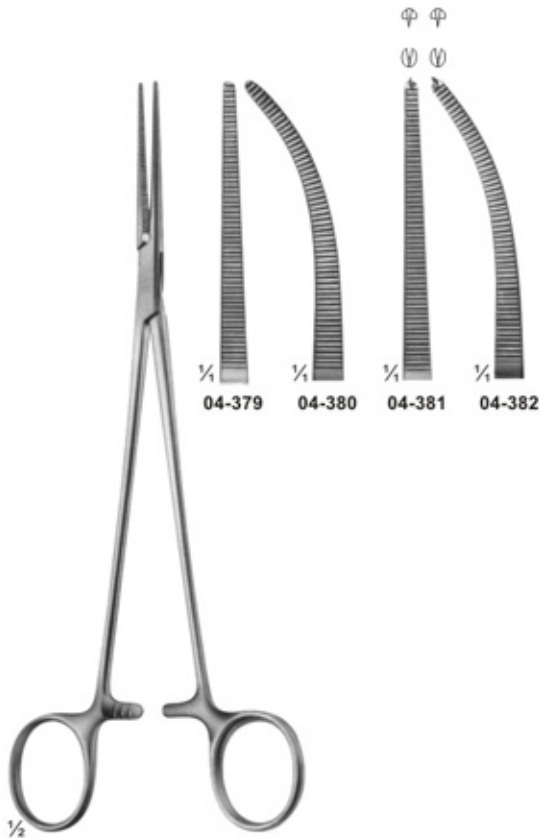

04-379 - 04-382
HALSTED-MOSQUITO
200 mm

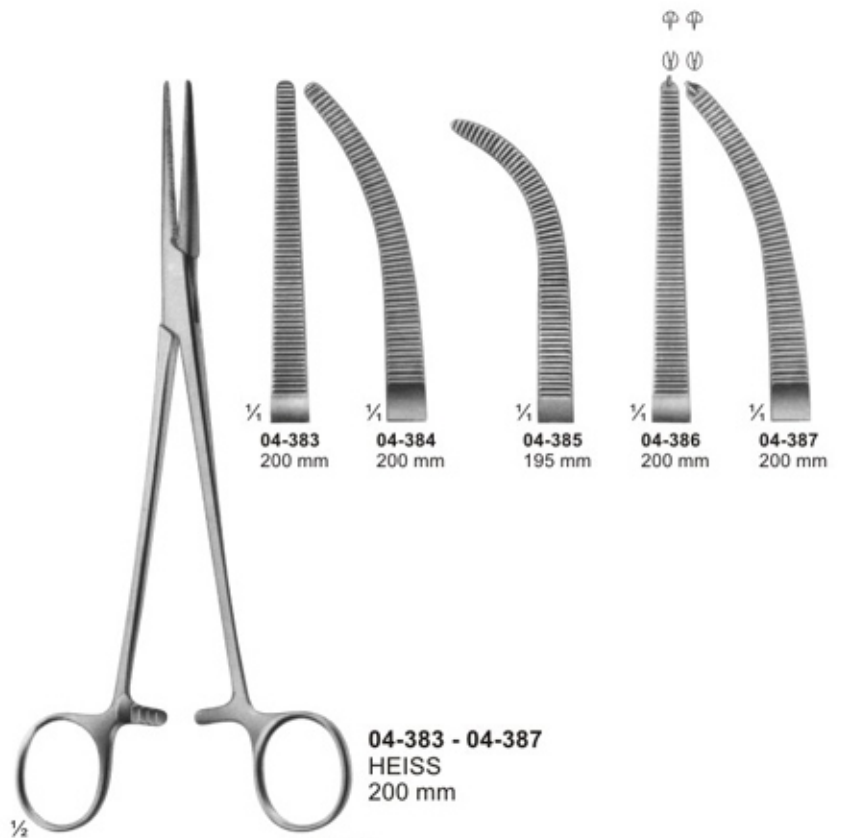

04-383 - 04-387
HEISS
200 mm



04-388 - 04-389
HALSTED
215 mm

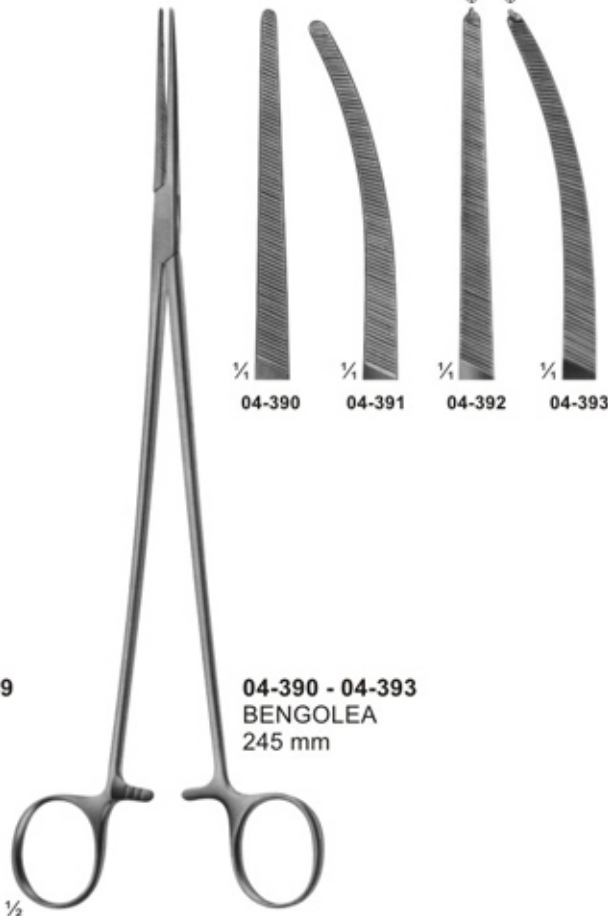

04-390 - 04-393
BENGOLEA
245 mm



04-394
CRAFOORD
245 mm

Delicate Haemostatic Forceps



04-395
CARREL
85 mm



04-396 - 04-399
BABY-MOSQUITO
(HARTMANN)
100 mm

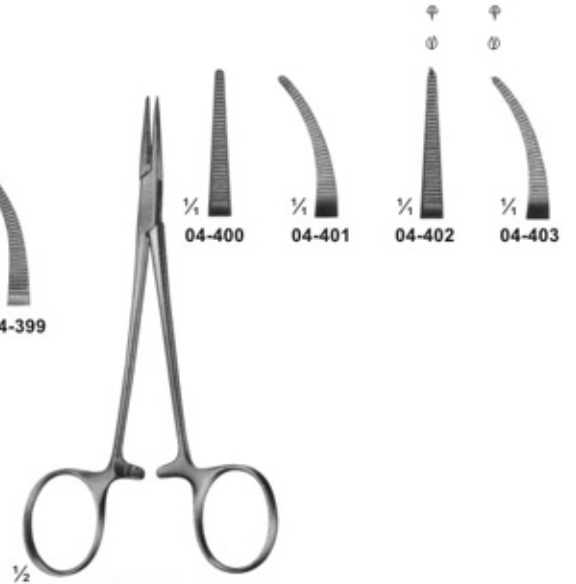

04-400 - 04-403
MICRO-HALSTED
125 mm

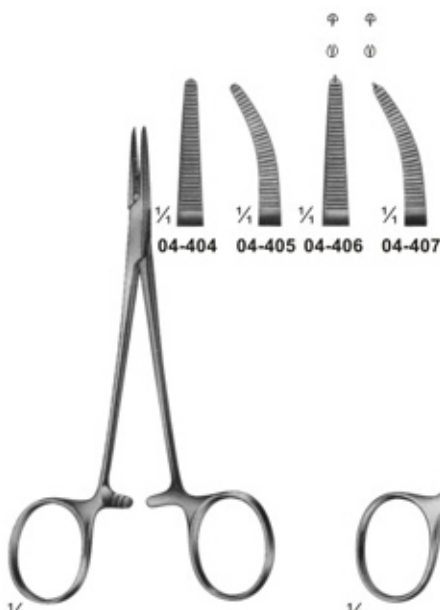

04-404 - 04-407
HALSTED-MOSQUITO
125 mm

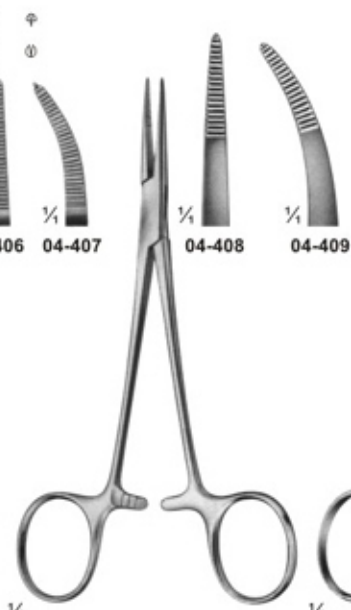

04-408 - 04-409
PROVIDENCE-HOSPITAL
140 mm



04-410 - 04-411
KELLY
140 mm

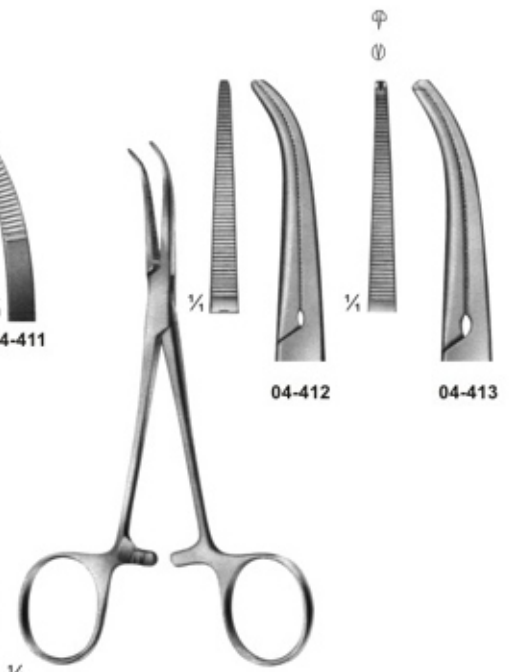

04-412 - 04-413
DANDY
Curved sideways
140 mm

Delicate Haemostatic Forceps

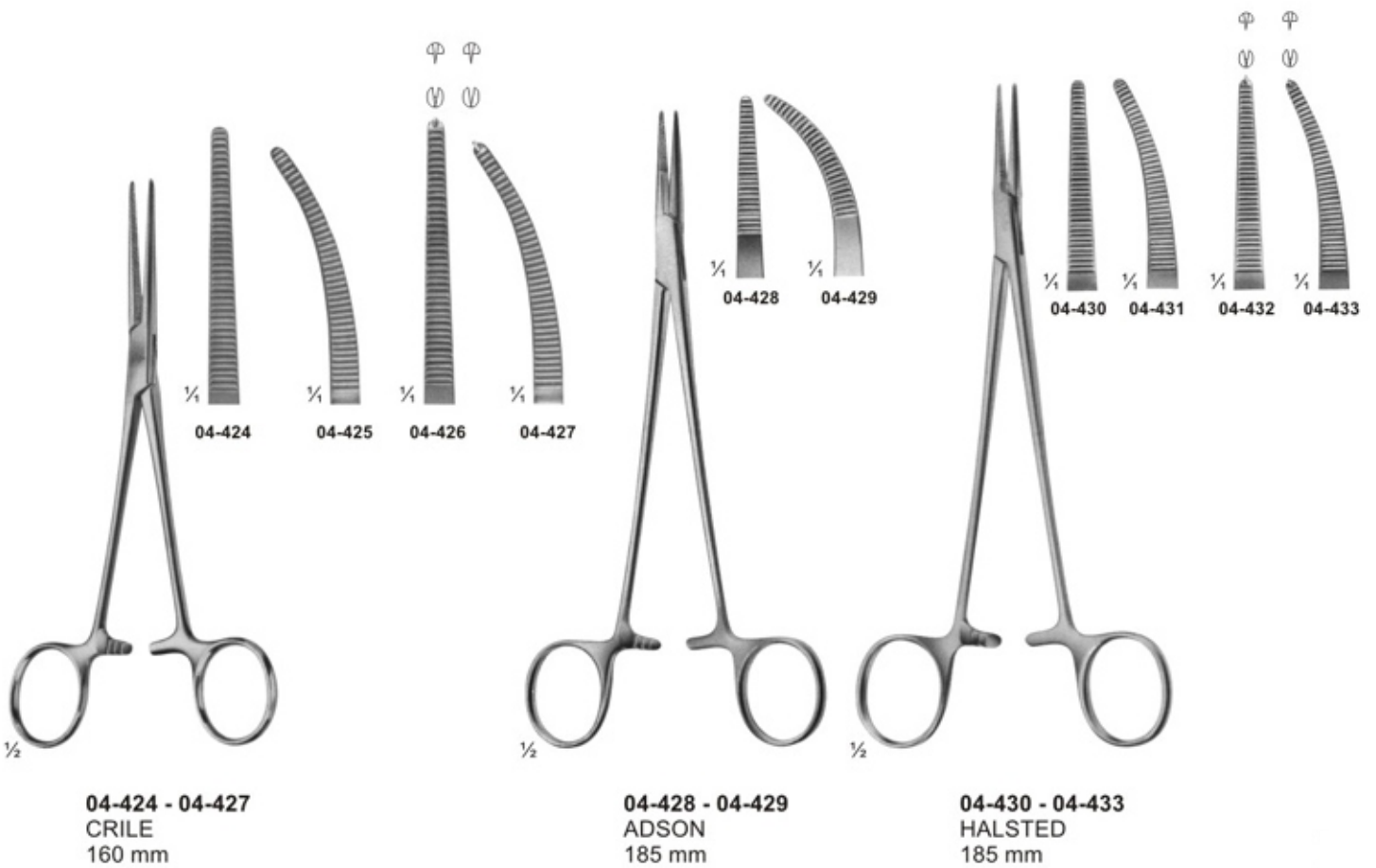
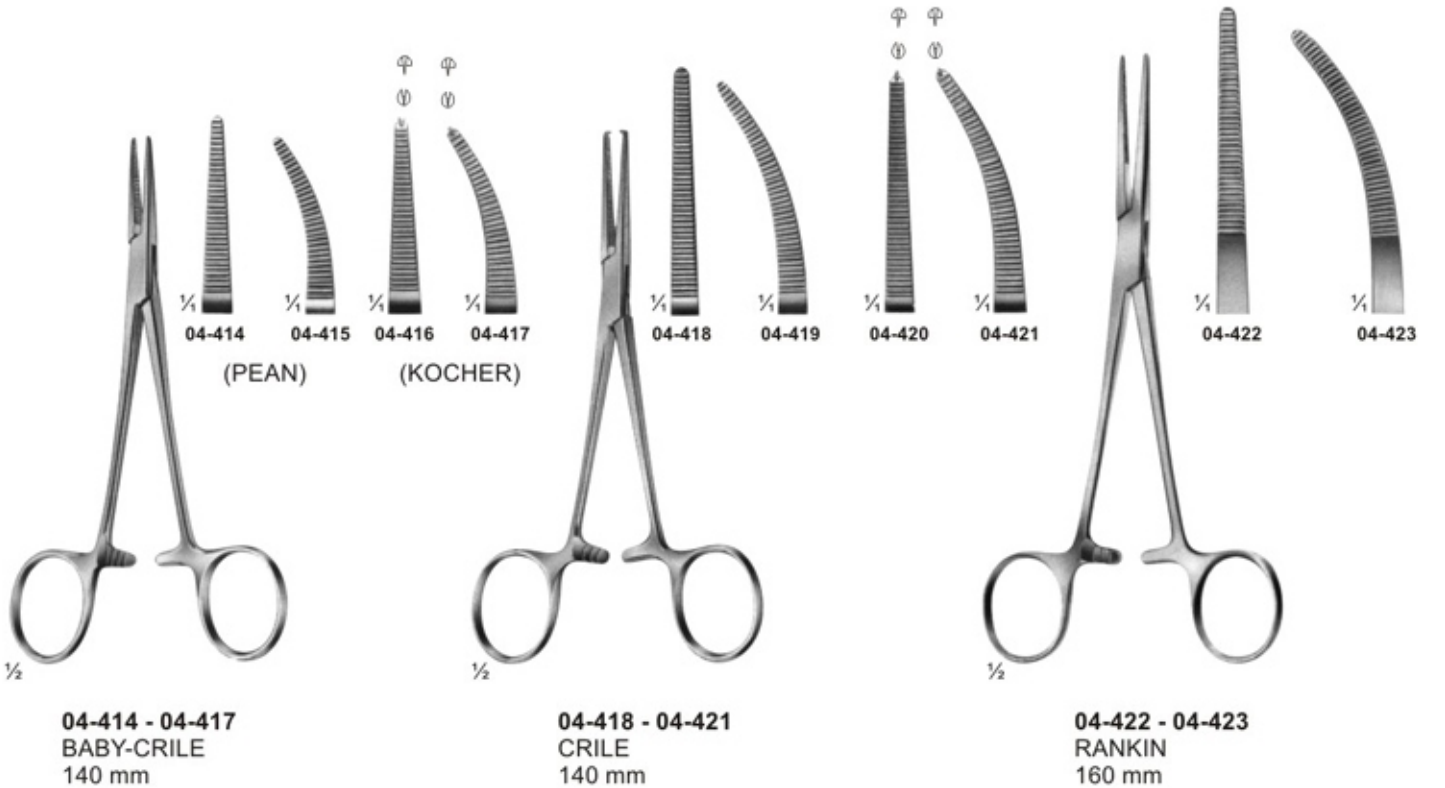

Haemostatic Forceps

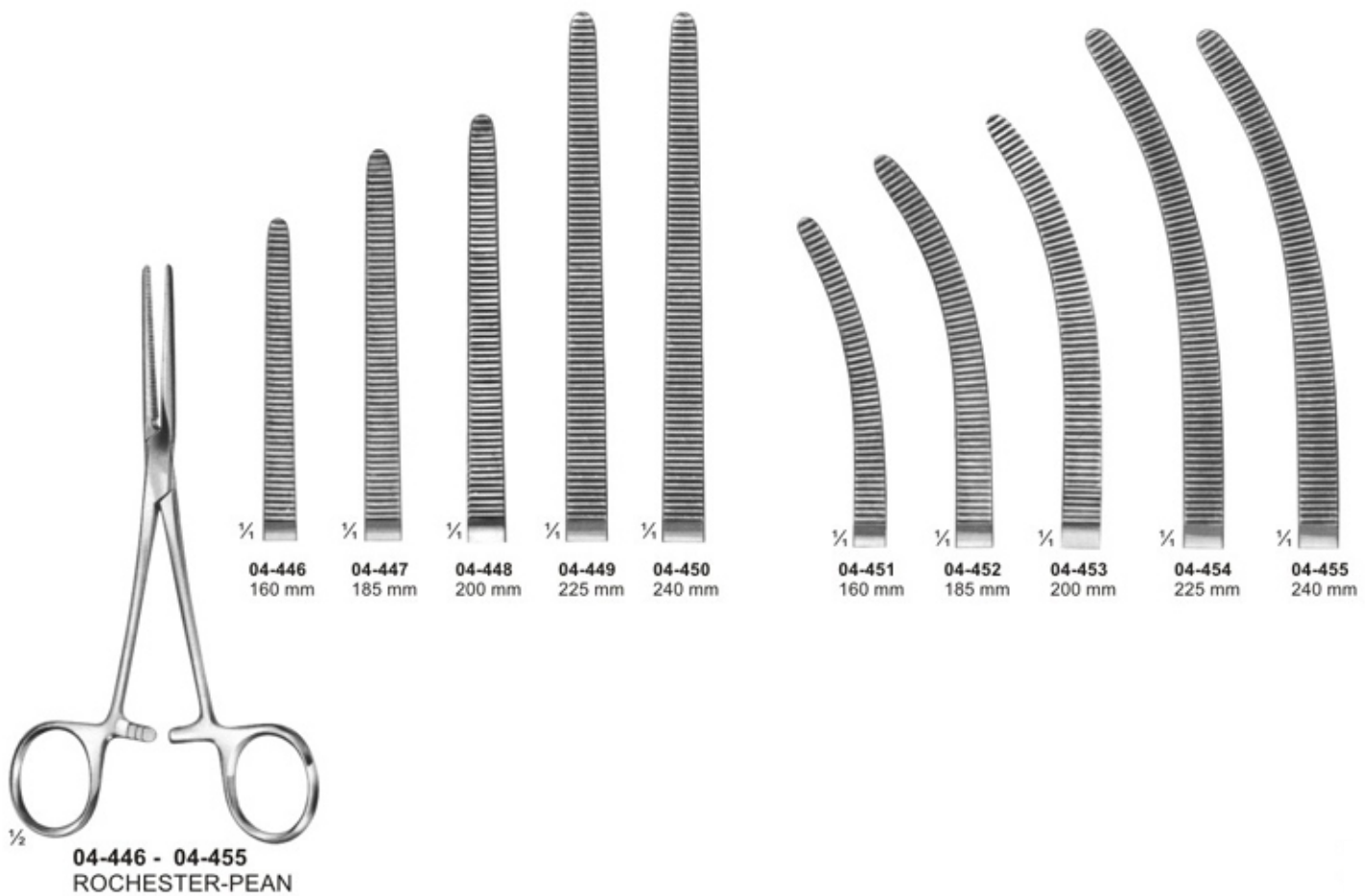

Haemostatic Forceps



04-456 - 04-461
PEAN

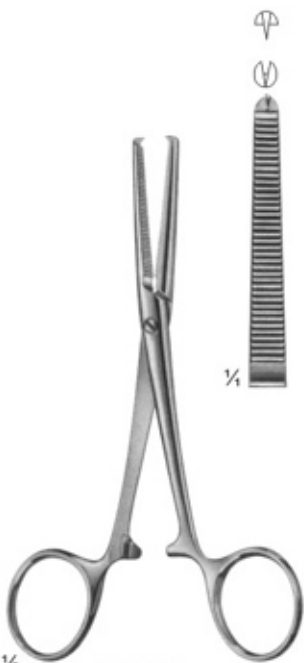
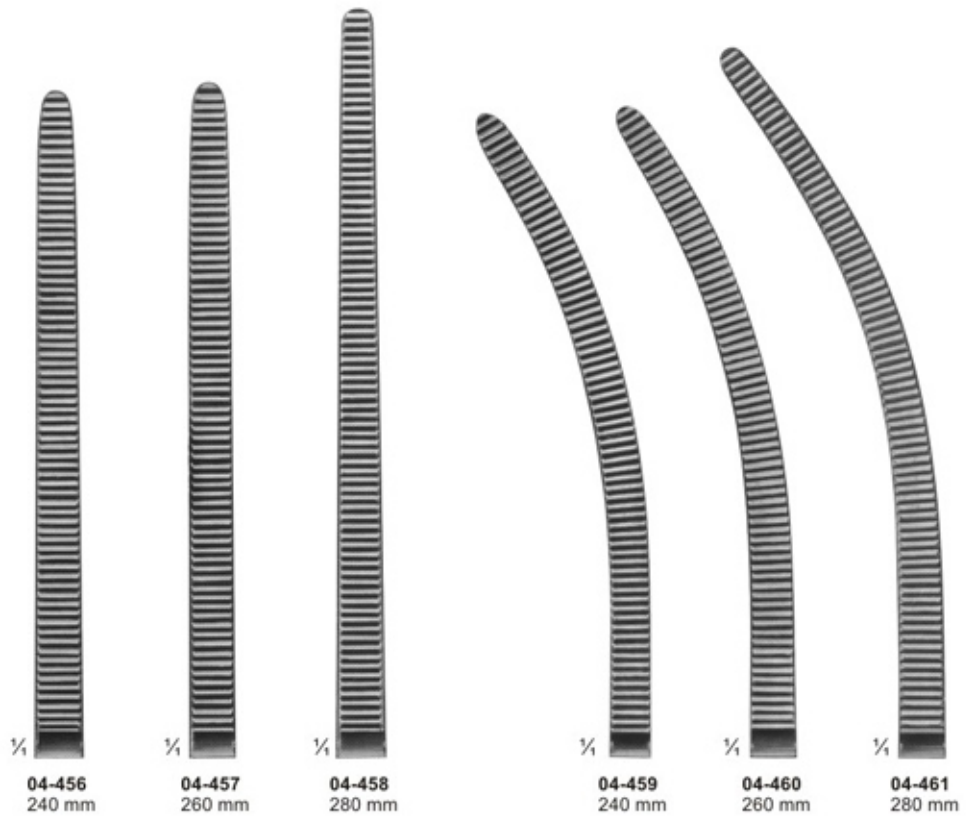

04-462
KOCHER
Strong Pattern
145 mm

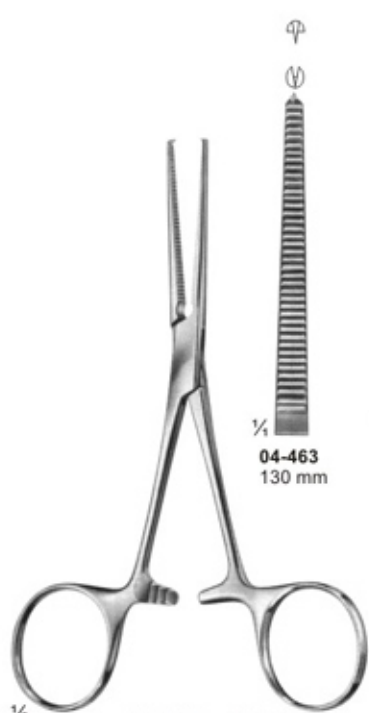

04-463 - 04-465
KOCHER

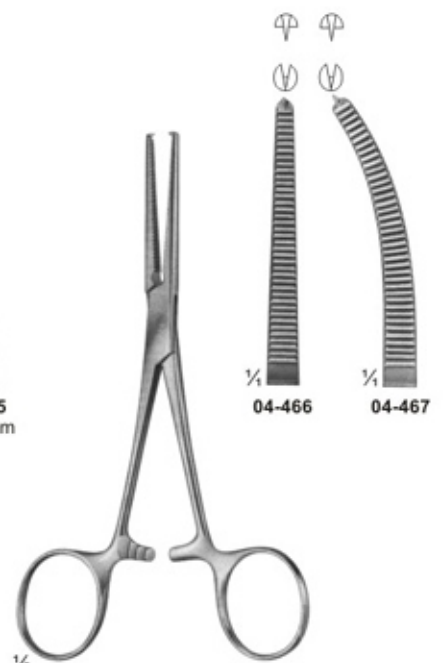

04-466 - 04-467
ROCHESTER-OCHSNER
140 mm

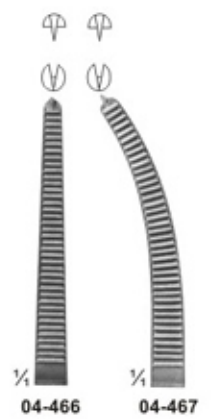

Haemostatic Forceps

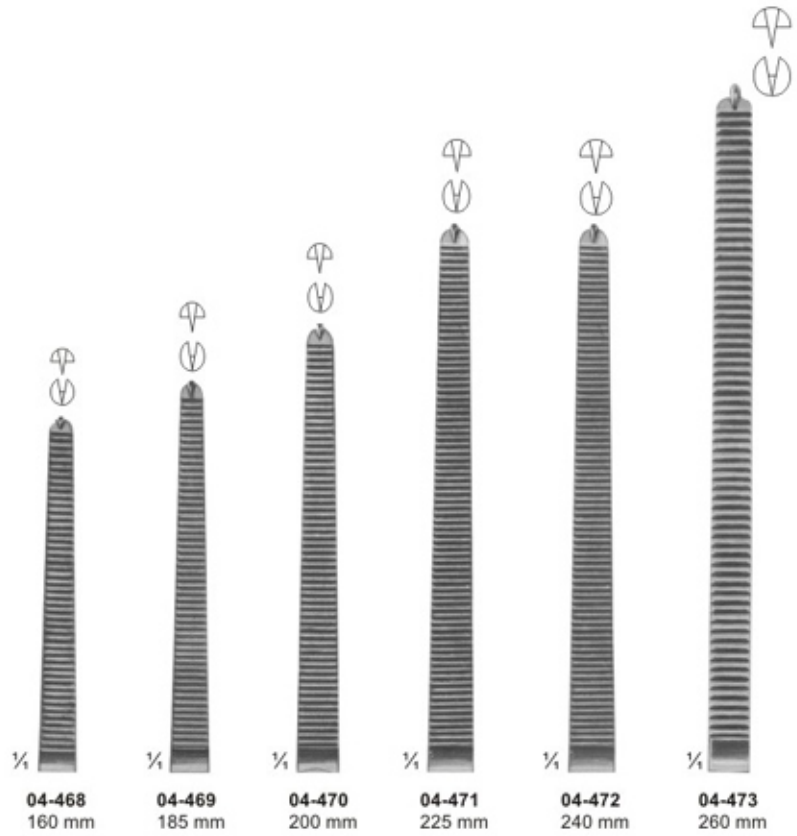

04-468 - 04-479
KOCHER-OCHSNER

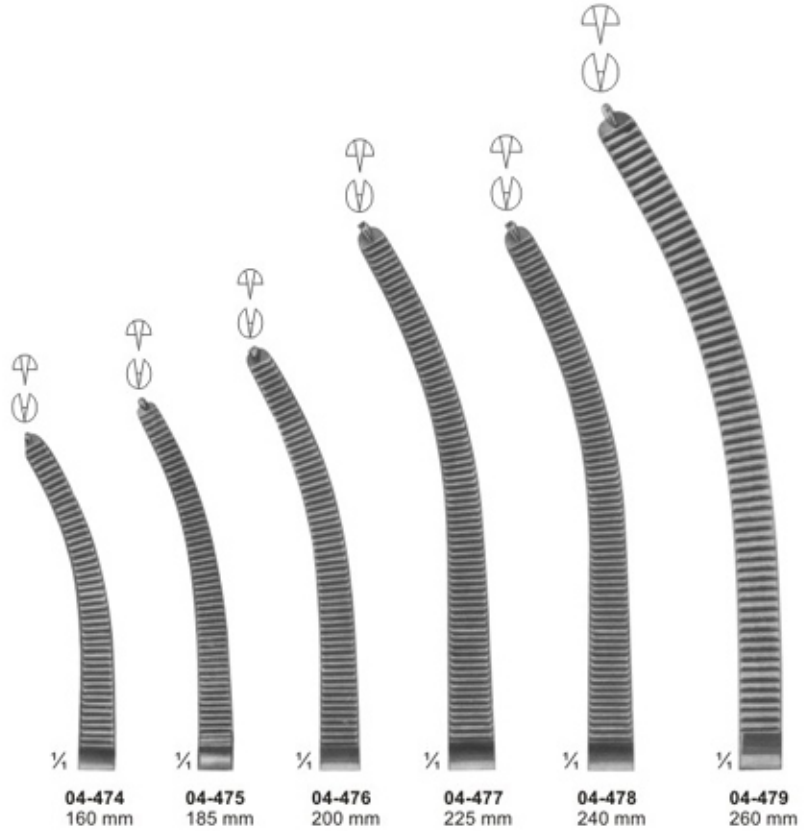

Haemostatic Forceps

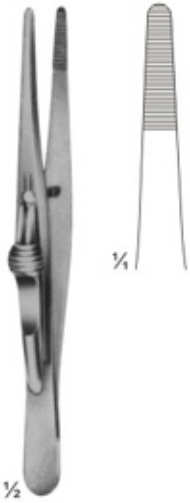

04-480
FRICKE
Artery forceps
130 mm



04-481
KRONLEIN
130 mm

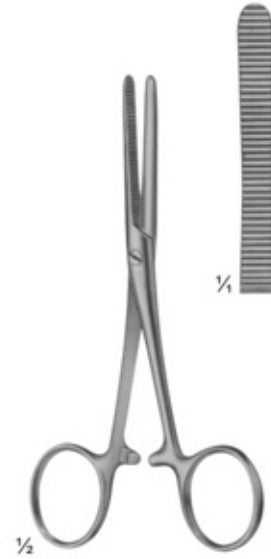

04-482
PEAN
125 mm



04-483
125 mm



04-484
140 mm

04-483 - 04-484
PEAN

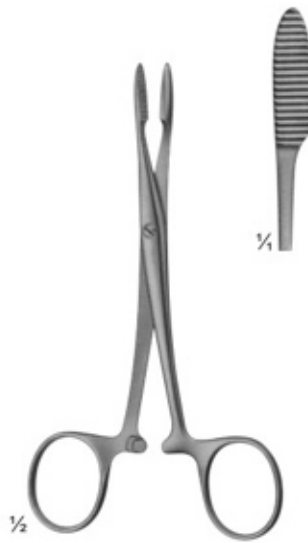

04-485
PEAN
125 mm

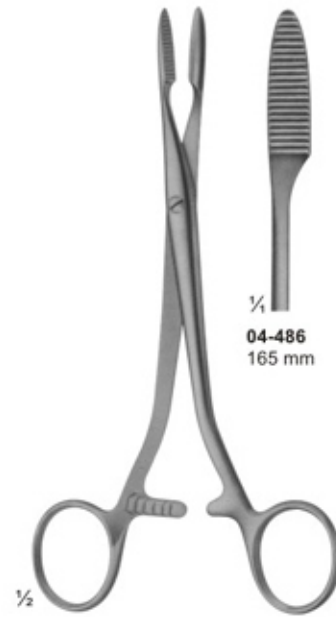

04-486
165 mm



04-487
185 mm

04-486 - 04-487
PEAN

Haemostatic Forceps, Special Pattern, Tonsil Forceps

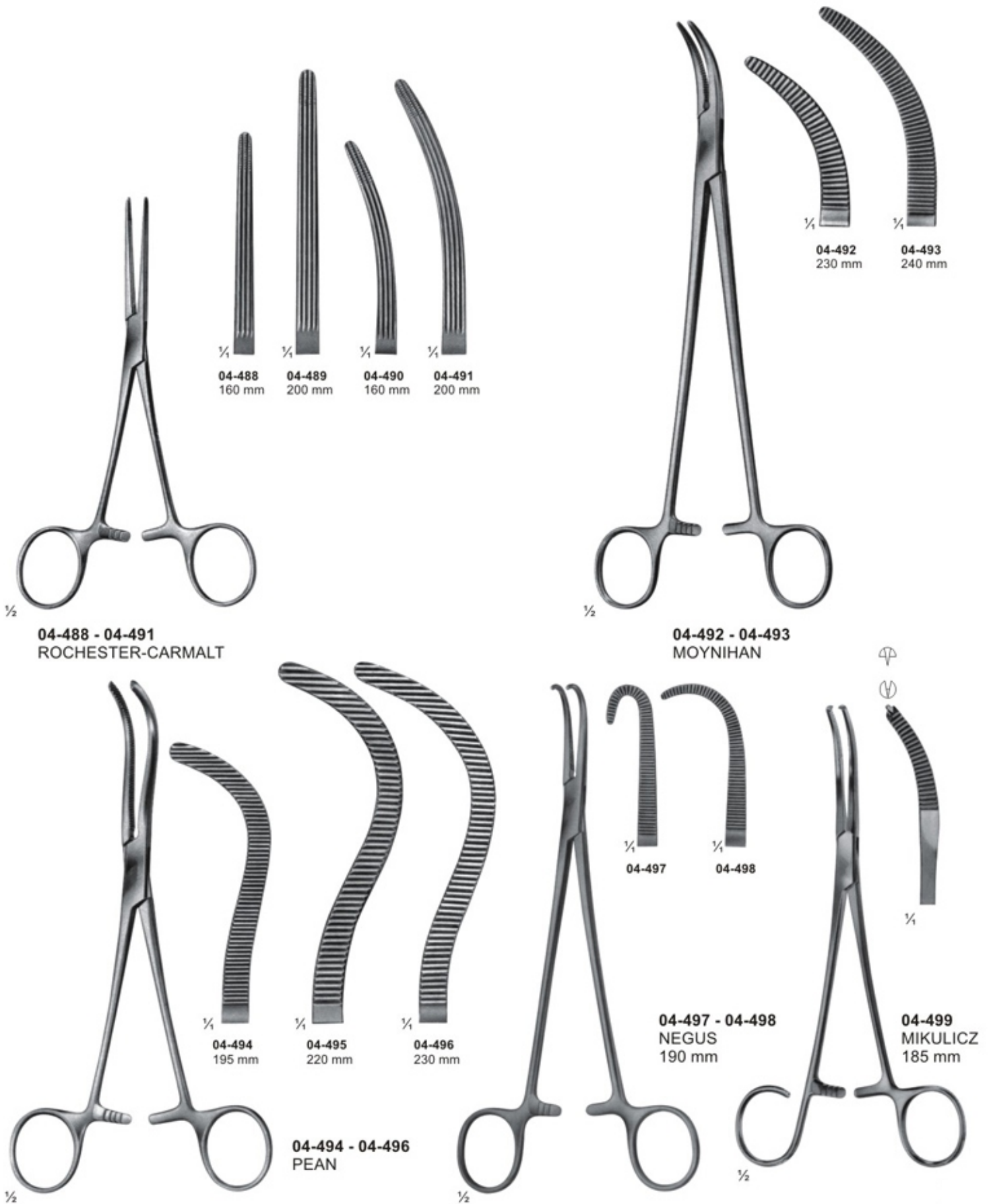

Dissecting- and Ligature Forceps



04-500
MIXTER-O'SHAUGHNESSY
190 mm



04-501
HEISS
195 mm

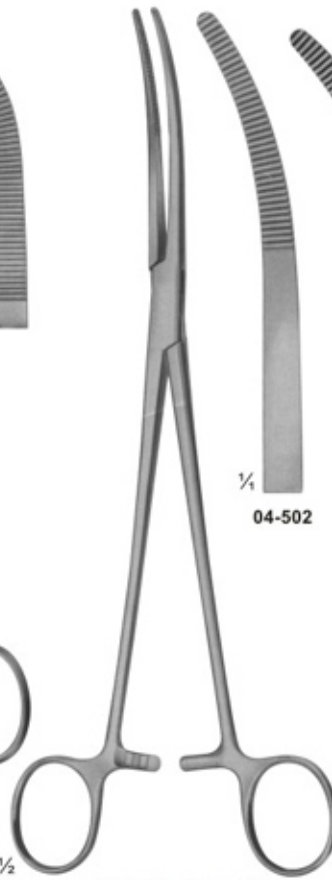

04-502 - 04-506
RUMEL
240 mm

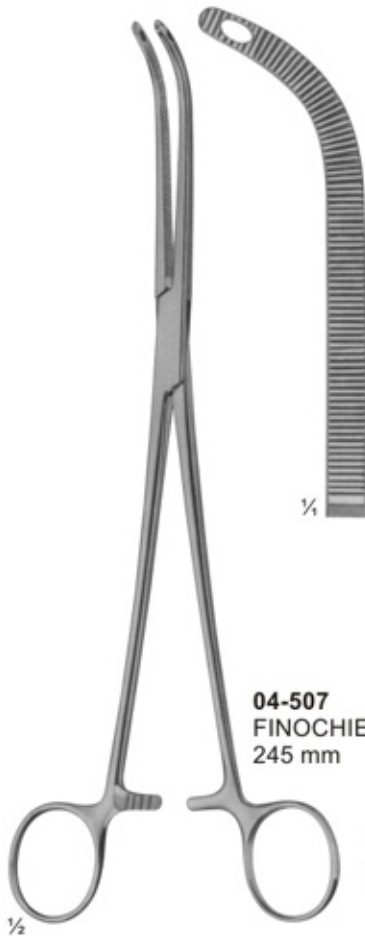

04-507
FINOCHIETTO
245 mm

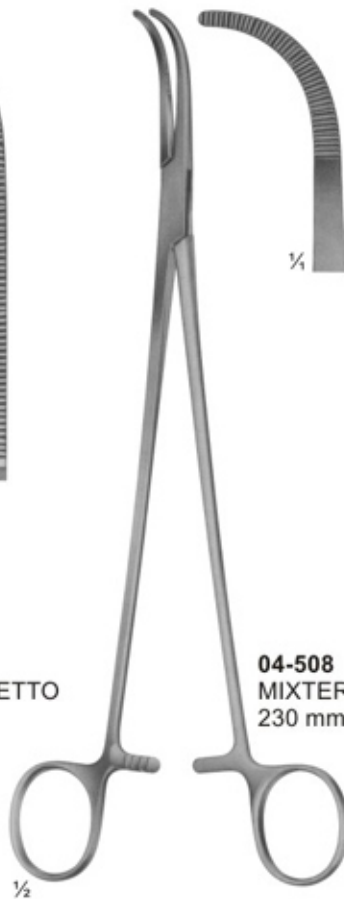

04-508
MIXTER
230 mm



04-509
LAWRENCE
270 mm

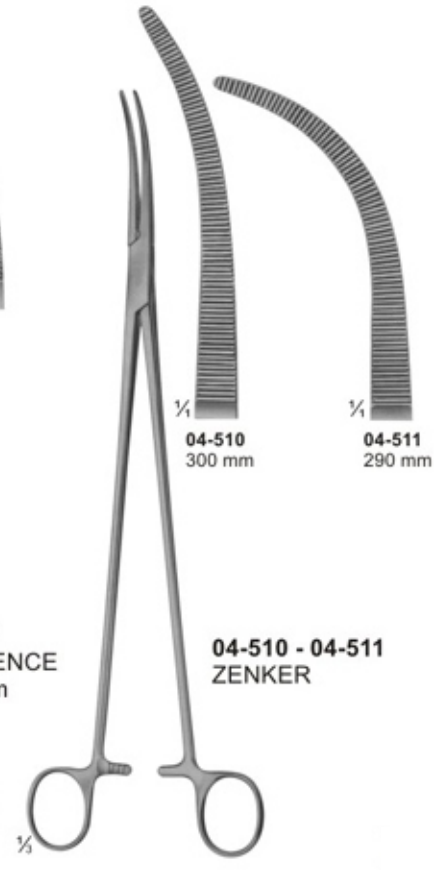

04-510 - 04-511
ZENKER

Hysterectomy Forceps, Vaginal Clamps and Compression Forceps



04-512
WERTHEIM
Hysterectomy forceps
255 mm

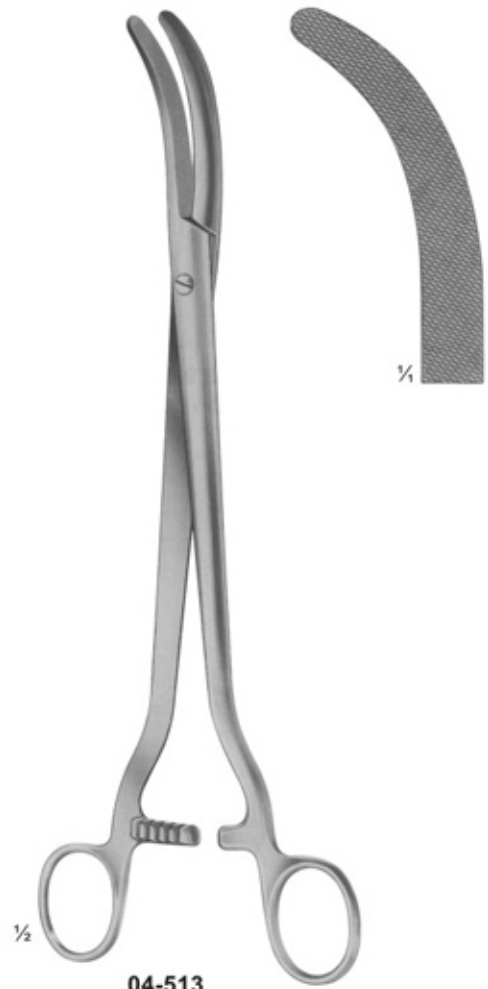

04-513
WERTHEIM
Parametrium clamp
260 mm

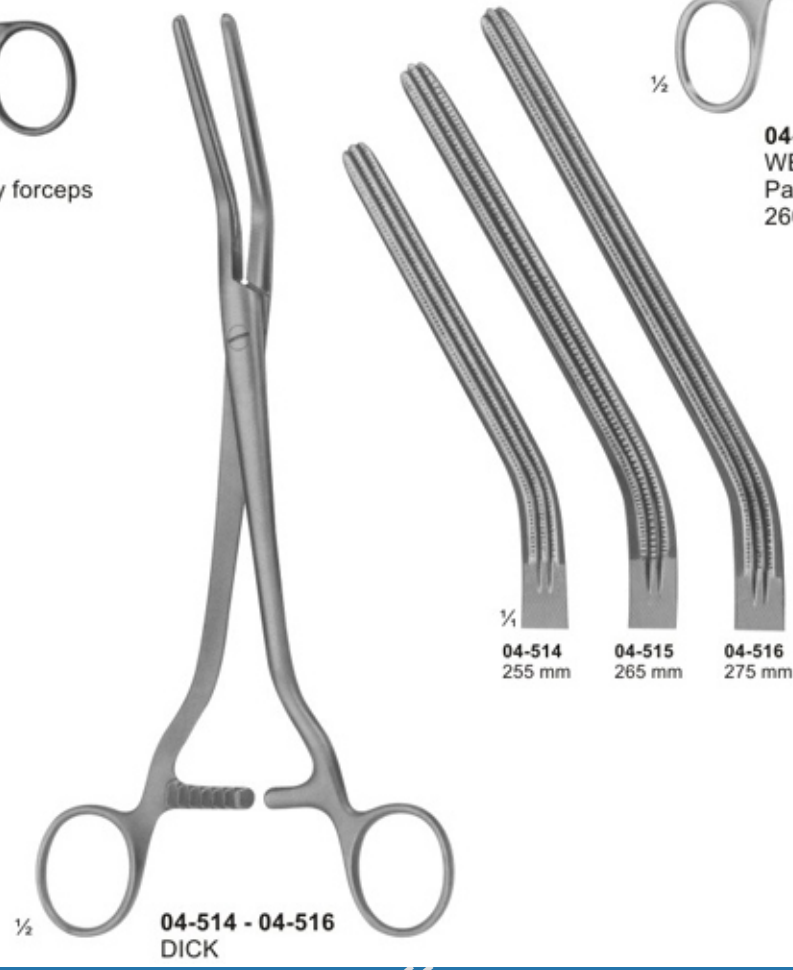

04-514 - 04-516
DICK

04-514 255 mm
04-515 265 mm
04-516 275 mm

Hysterectomy Forceps, Vaginal Clamps and Compression Forceps

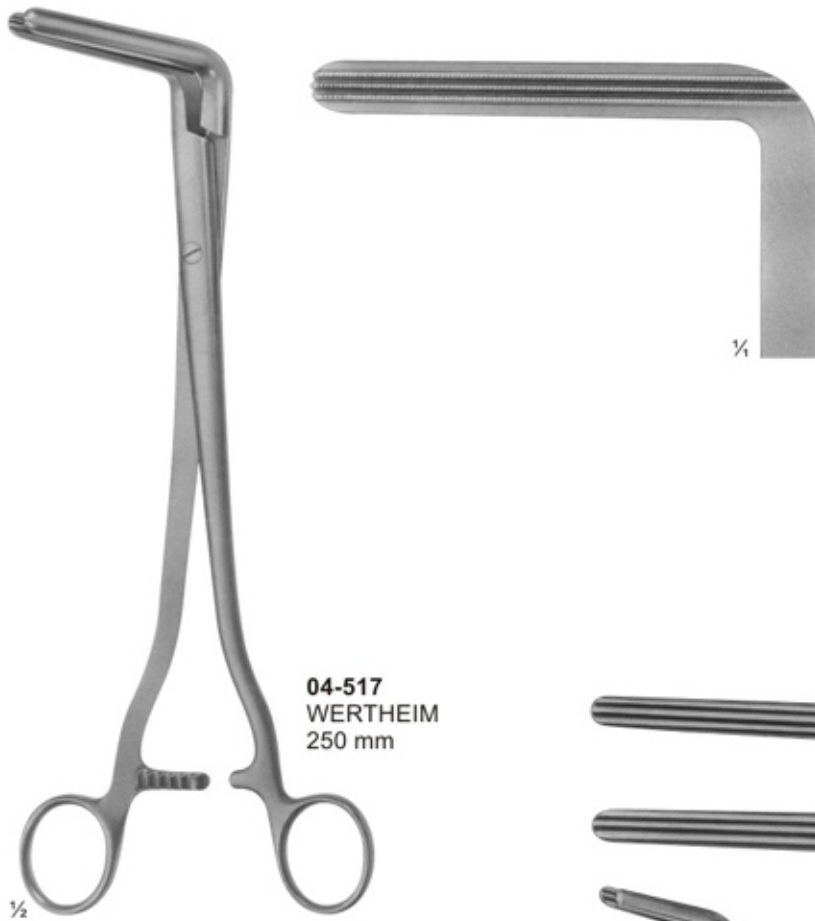

04-517
WERTHEIM
250 mm

1/2

1/4

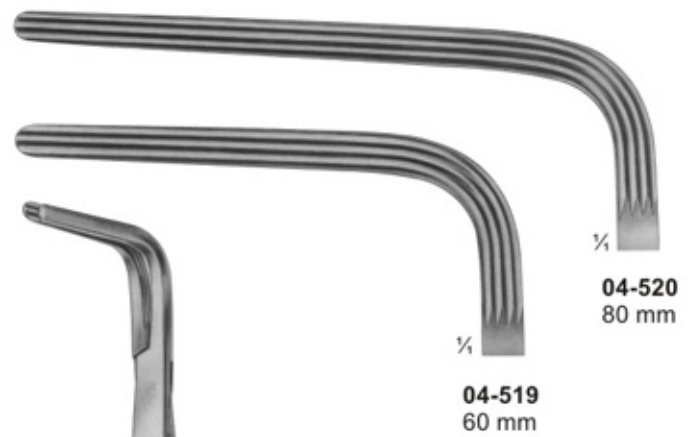

1/4

1/4

04-520
80 mm

04-519
60 mm



04-518
WERTHEIM-CULLEN
215 mm

1/2

1/4



04-519 - 04-520
230 mm

1/2

Needle Holders for micro surgery



05-101
ROHRSCHEIDER
with copper inserts
100 mm



05-102
KALT
with catch
135 mm



05-103
ARRUGA
with catch
135 mm



05-104 - 105
CASTROVIEJO
with catch
145 mm



05-106 - 107
without Catch
160 mm



05-108 - 109
without catch
185 mm



05-110 - 111
JACOBSON
without catch
185 mm

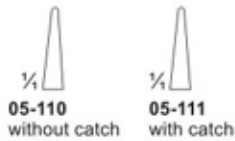

05-112
without catch
195 mm



05-113 - 114
YASARGIL
with catch
200 mm



Needle Holders

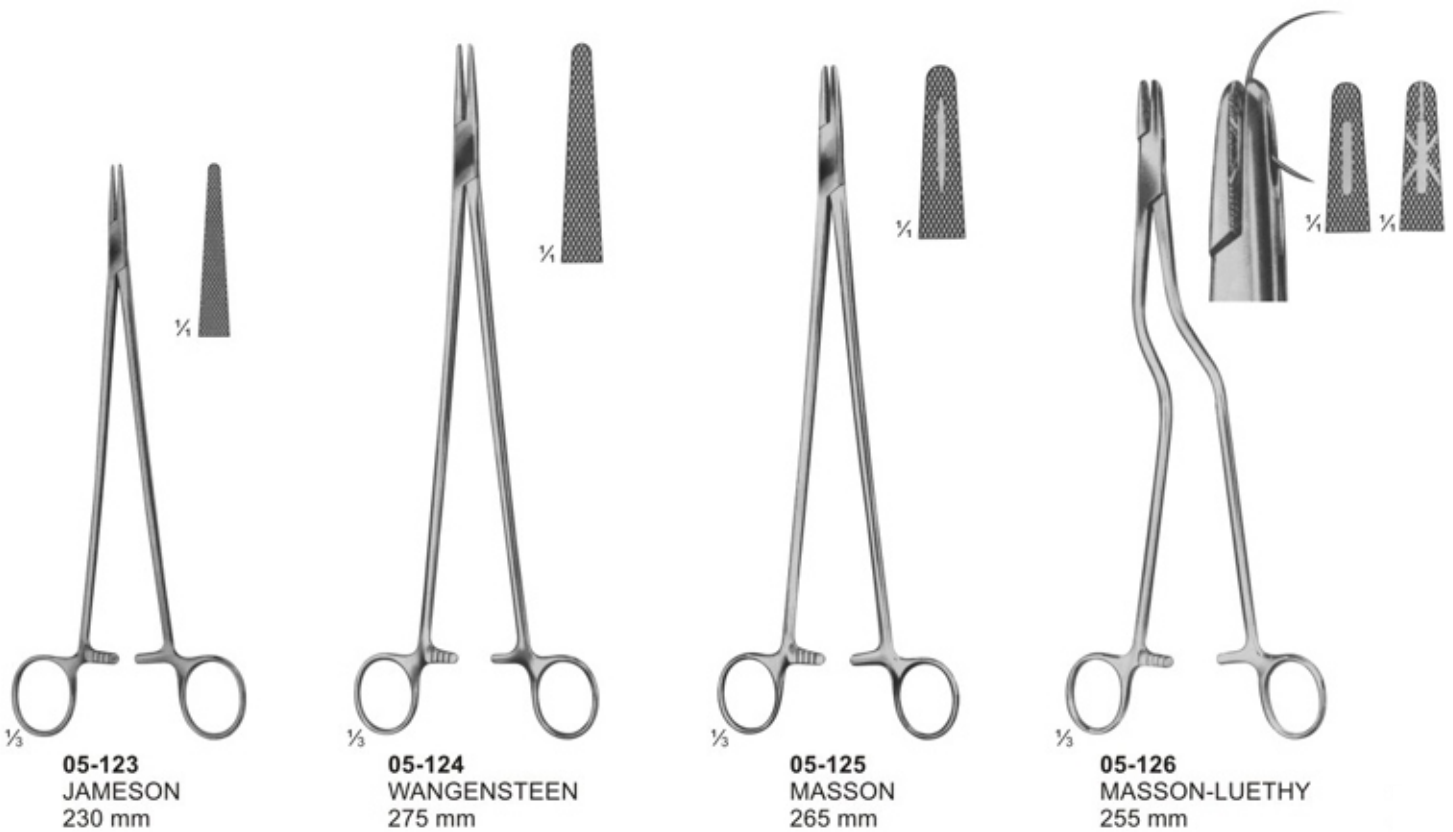

Needle Holders

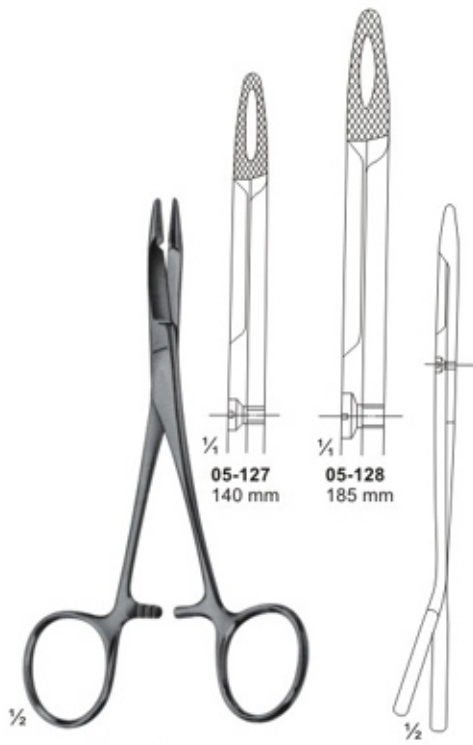

05-127 - 128
HEGAR-OLSEN
255 mm

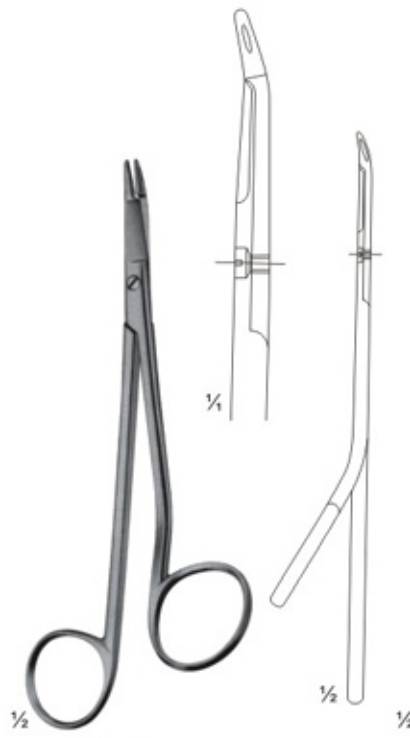

05-129
GILLIES
150 mm



05-130
GILLIES
160 mm



05-131
EISELSBERG
115 mm

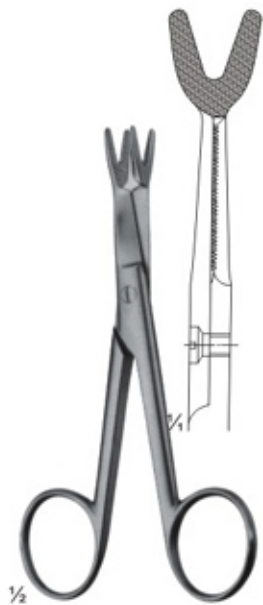

05-132
SCHOEMAKER-LOTH
125 mm



05-133
CRILE
150 mm



05-134
TOENNIS
Elastic pattern for dura-or
intestinal suture. 180 mm

Needle Holders

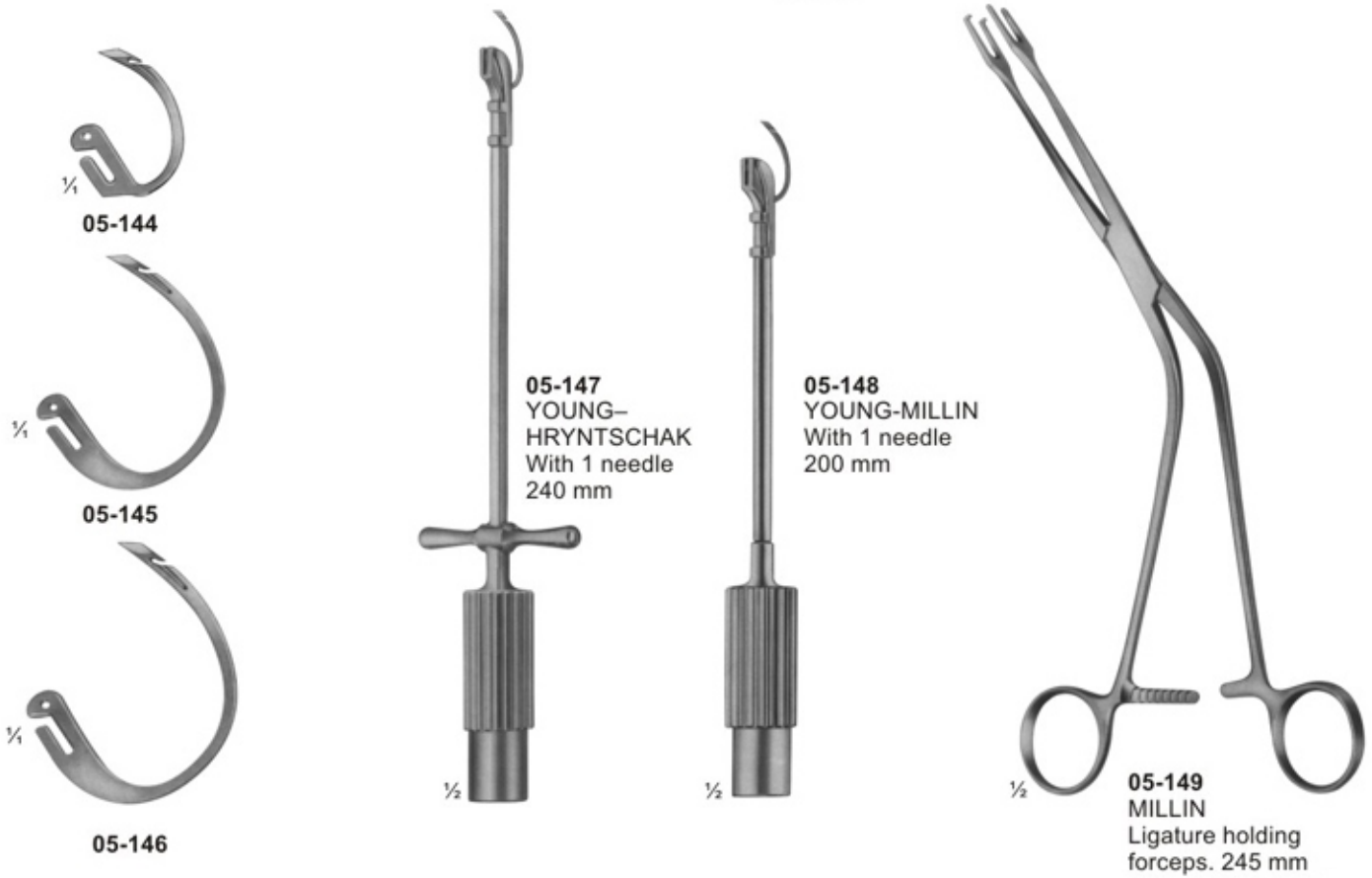
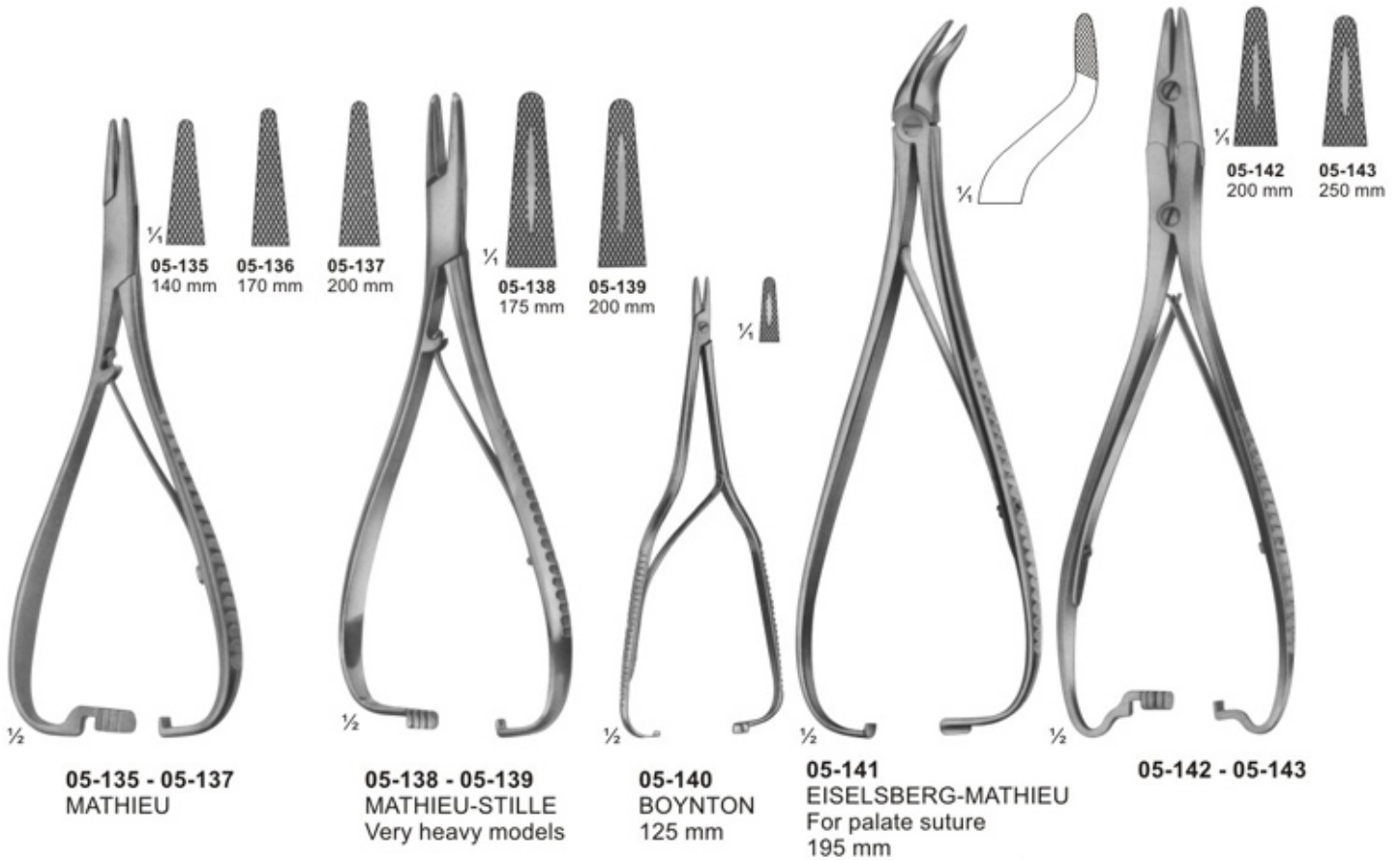

Suture Instruments - Reverdin Needles

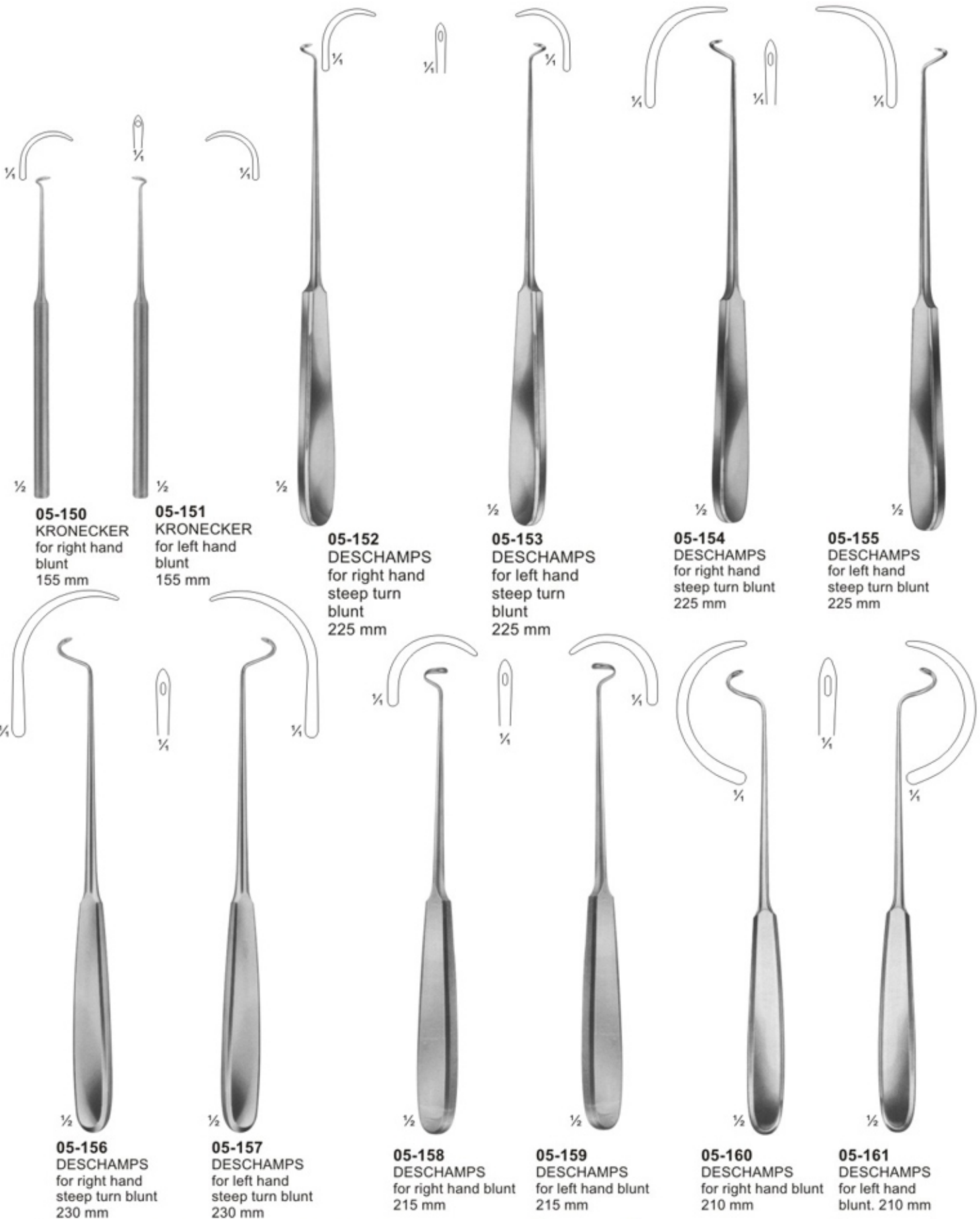

Probes



05-162 130 mm
05-163 145 mm
05-164 160 mm
 Directors



05-165
DOYEN
 145 mm
 Directors

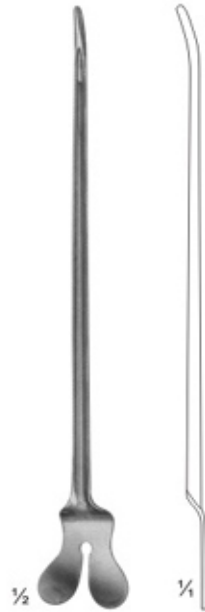

05-166
NELATON
 160 mm
 Directors



05-167
 Director with tip
 Diam. Of tip 3,3 mm
 140 mm

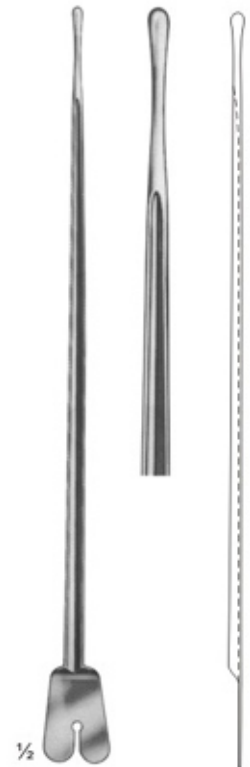

05-168
BRODIE
 Director with tip,
 Diam. Of tip 3,5 mm
 200 mm

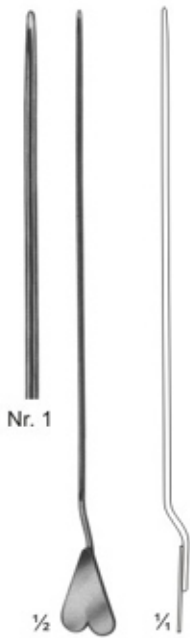

05-169
LOCKHART-MUMMERY
 165 mm

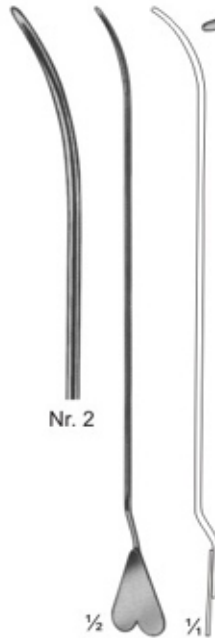

05-170
LOCKHART-MUMMERY
 165 mm

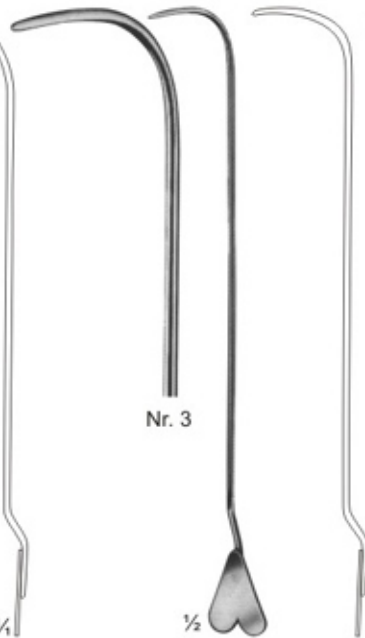

05-171
LOCKHART-MUMMERY
 165 mm

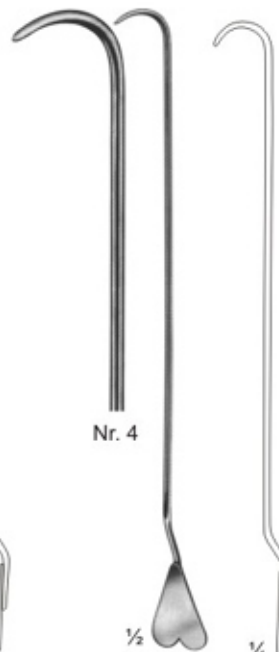

05-172
LOCKHART-MUMMERY
 165 mm



05-173
 Director with wire
 loop, malleable
 190 mm

Probes



05-174
2,5 mm
05-175
2,5 mm
05-176
3,0 mm

1/2

05-174 145 mm
05-175 160 mm
05-176 200 mm
Probes with eye



1,5 mm

1/2

05-177
Myrtle leaf probe
145 mm



2,0 mm

1/2

05-178 130 mm
05-179 145 mm
05-180 160 mm
05-181 180 mm
05-182 200 mm



1/2

05-183
Probes



1/2

05-184
Double ended probe,
malleable, diam. of tips
3 mm with hole
190 mm



05-185

Double ended probes,
tin, malleable,
diam. of tips
3,5 mm with hole
250 mm, 300 mm



1/4

05-186
Double ended probes,
tin, malleable,
diam. of tips 4 mm
400 mm



1/4

05-187 1,5 mm
05-188 2,0 mm
05-189 2,5 mm
300 mm

Suturing Instrument Set, Pocket Instrument Set



05-190

Suturing instruments set, in metal case consisting of: Scissors, curved, sharp/sharp, 115mm
25 MICHEL clip, 16 x 3mm
1 Delicate tissue forceps, 130mm
1 Scalpel, bellied
1 MATHIEU needle holder, 140mm
1 Perforated metal case, stainless containing:
1 Suture needle
1 item 1 item



05-191

Pocket instrument set, in metal case consisting of:

Bottom tray

1 MATHIEU needle holder, 140mm
1 MICHEL clip forceps, combined
1 Myrtle leaf probe, 130mm
1 Sharp double curette
1 Skin hook
1 Detachable scalpel handle, no.4
1 Perforated metal case, containing
6 Scalpel blades
1 Perforated metal case, stainless, containing
1 Suture needle
1 item
1 item

Top tray

1 Tissue forceps, 130mm
1 KOCHER haemostatic forceps, 130mm
1 Straight surgical scissors, 130mm
1 Dissecting forceps, 130mm
1 FEILCHENFELD splinter forceps, 115mm
25 MICHEL clip, 16 x 3mm
1 Flacon of suture skin, sterile in alcohol



05-192

Pocket instrument set, in metal case consisting of:

Bottom tray











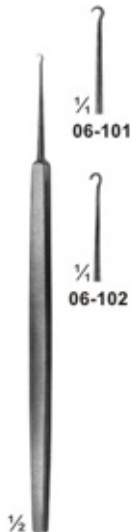
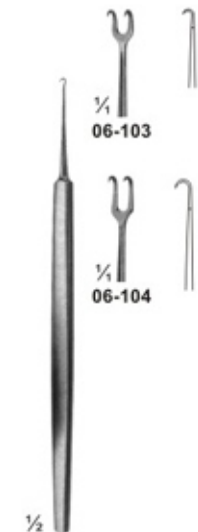





1 MAYO-HÉGER needle holder, 150mm
1 MICHEL clip forceps, combined
1 Myrtle leaf probe, 130mm
1 Sharp double curette
1 Skin hook
1 Detachable scalpel handle, no. 4
1 Perforated metal case, consisting
6 Scalpel blades
1 Perforated metal case, stainless, consisting:
1 Suture needle
1 item, & 1 item

Top tray

1 Tissue forceps, 130mm
1 CRILE haemostatic forceps, 140mm
1 Straight surgical scissors, 130mm
1 Dissecting forceps, 130mm
1 FEILCHENFELD splinter forceps, 115mm
25 MICHEL clip, 16 x 3mm
1 Flacon of suture silk, sterile in alcohol



Fine Wound Retractors (Dura- and Skin Retractors)

 <p>06-101 Sharp 06-102 Blunt GRAEFE 125 mm</p>	 <p>06-103 125 mm 06-104 130 mm sharp GUTHRIE</p>	 <p>06-105 130 mm 06-106 135 mm sharp ROLLET 06-107 135 mm blunt</p>	 <p>06-108 FRAZIER Dura retractors 130 mm</p>	 <p>06-109 TONNIS Dura retractors 150 mm</p>	 <p>06-110 KILNER 160 mm</p>	 <p>06-111 FREER 150 mm</p>			
 <p>06-112 MULLER 150 mm</p>	 <p>06-113 MULLER 150 mm</p>	 <p>06-114 COTTLE 160 mm</p>	 <p>06-115 COTTLE 160 mm</p>	 <p>06-116 JAEGER 135 mm</p>	 <p>06-117 - 120 JOSEPH 165 mm</p>	 <p>06-117 3 mm 06-118 6 mm 06-119 8 mm</p>	 <p>06-121 - 122 GILLIES 180 mm</p>	 <p>06-123 KILNER sharp 80 mm</p>	 <p>06-124 CONVERSE blunt 120 mm</p>

Retractors With treangle handle

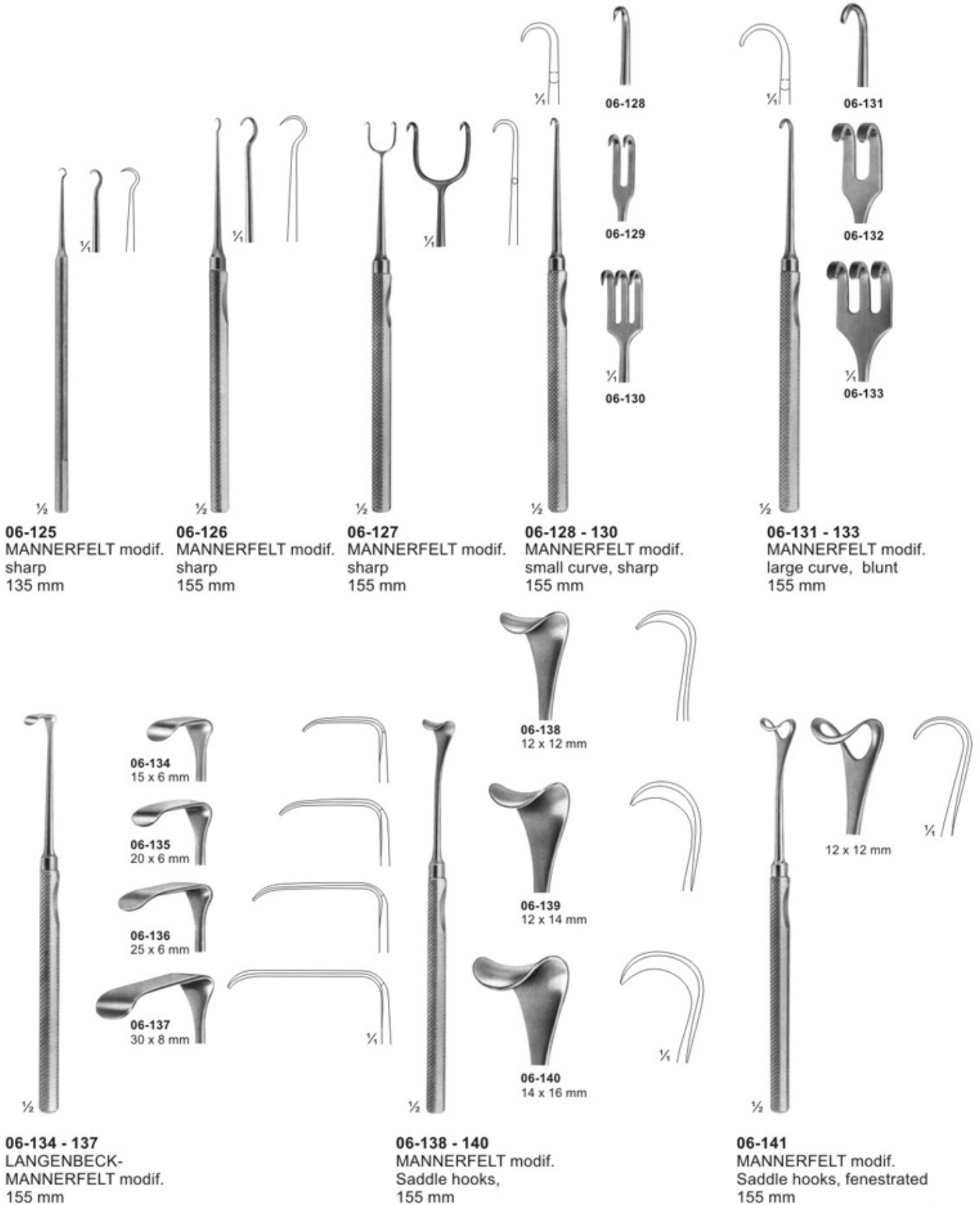

Retractors



¼
6 x 12 mm

½
06-142
MASING
140 mm



¼
10 x 12 mm

½
06-143
COTTLE
140 mm



06-144
9 x 9 mm



06-145
9 x 12 mm



¼
06-146
11 x 14 mm



06-147
12 x 16 mm



¼
06-148
13 x 18 mm



¼
06-149
13 x 13 mm



¼
10 x 10 mm

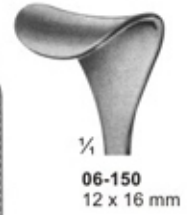

¼
06-150
12 x 16 mm

½
06-149 - 150
KONIG
180 mm

½
06-151
CUSHING-KOCHER
175 mm



¼
06-152
20 x 12 mm



¼
06-153
20 x 15 mm

½
06-152 - 153
KOCHER
205 mm



¼
13 x 6 mm

½
06-154
SCHOENBORN
200 mm



¼
06-155
10 x 13 mm



¼
06-156
14 x 18 mm

½
06-155 - 156
CUSHING
205 mm



20 x 15 mm

20 x 19 mm

½
06-157
205 mm

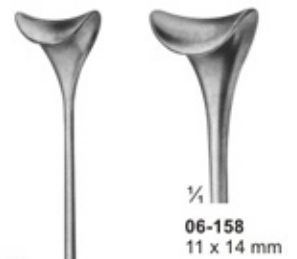

¼
06-158
11 x 14 mm



¼
06-159
13 x 18 mm



¼
06-160
15 x 22 mm

½
06-158 - 160
CUSHING
250 mm

Retractors



Retractors

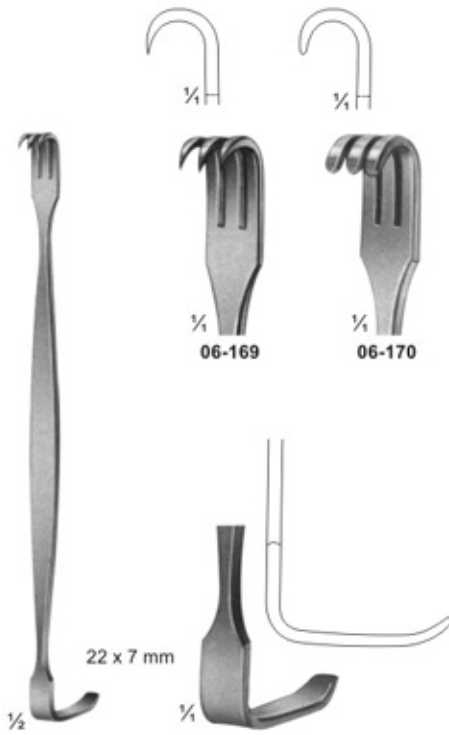

06-169 - 06-170
BABY-SENN-MILLER
155 mm

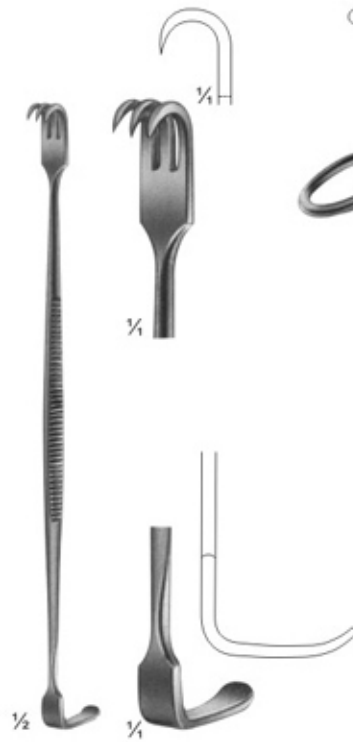

06-171
SENN-MILLER
165 mm

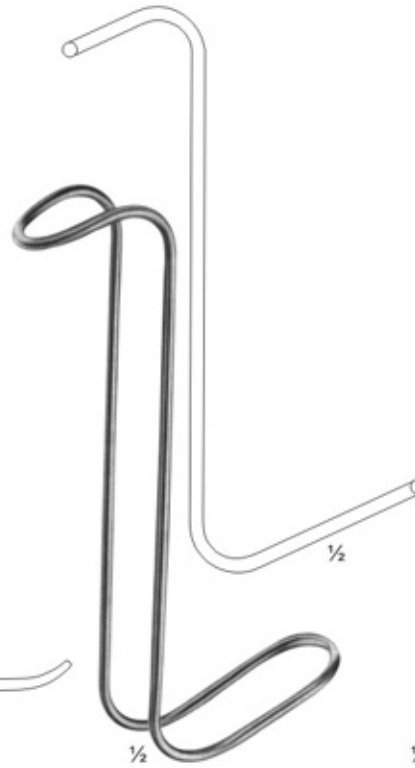

06-172
COLLIN-HARTMANN
150 mm

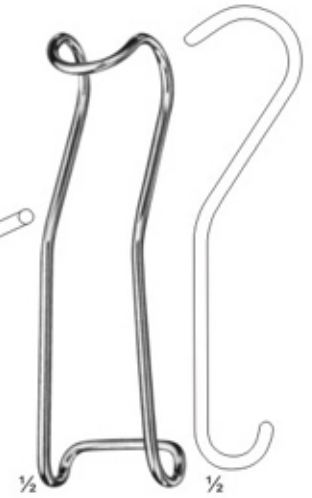

STERBERG
06-173 120 mm
06-174 130 mm
06-175 135 mm
06-176 140 mm



06-177
LUER
110 mm

06-178
ROSE
130 mm

06-179
BABY-ROUX
135 mm



06-180
PARKER
135 mm

06-181
CRILE
110 mm

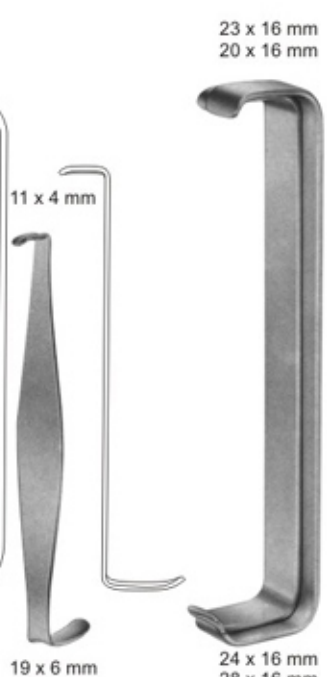

06-182
FARABEU
150 mm

06-183
COLLIN
150 mm

Bone Retractors and Retractors



06-184
KOCHER
sharp
205 mm



06-185
KOCHER
sharp
220 mm



06-186
KOCHER
sharp
220 mm



06-187
VOLKMANN
blunt
220 mm



06-188
VOLKMANN
sharp
220 mm



06-189 - 06-196
VOLKMANN
225 mm



06-189
9 x 8 mm



06-190
9 x 13 mm



06-191
9 x 19 mm



06-192
9 x 29 mm



06-193
8,5 x 8 mm



06-194
8,5 x 13 mm



06-195
8,5 x 19 mm



06-196
8,5 x 29 mm

Retractors

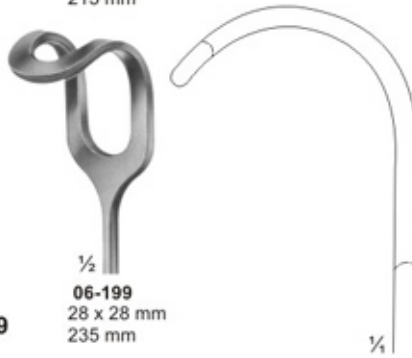
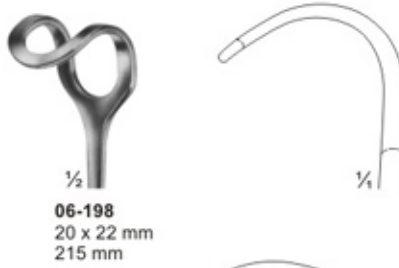

1/2
06-197 - 06-199
 MIDDELDORPF



1/2
06-201
 CASPAR
 210 mm

1/2
06-202
 KOCHER
 230 mm

Retractors, Vario Retractor System



- 06-203-06-209**
- BRUNNER**
- 275 mm
- 06-203** 80 x 20
- 06-204** 100 x 25
- 06-205** 120 x 25
- 06-206** 130 x 30
- 06-207** 140 x 30
- 06-208** 160 x 30
- 06-209** 180 x 30



06-210
Handle with cold light carrier for retractor blades.
280 mm



Handle arrangement verriable

Retractors, Lung Spatulas



Retractors for deep surgery (Abdominal Retractors)

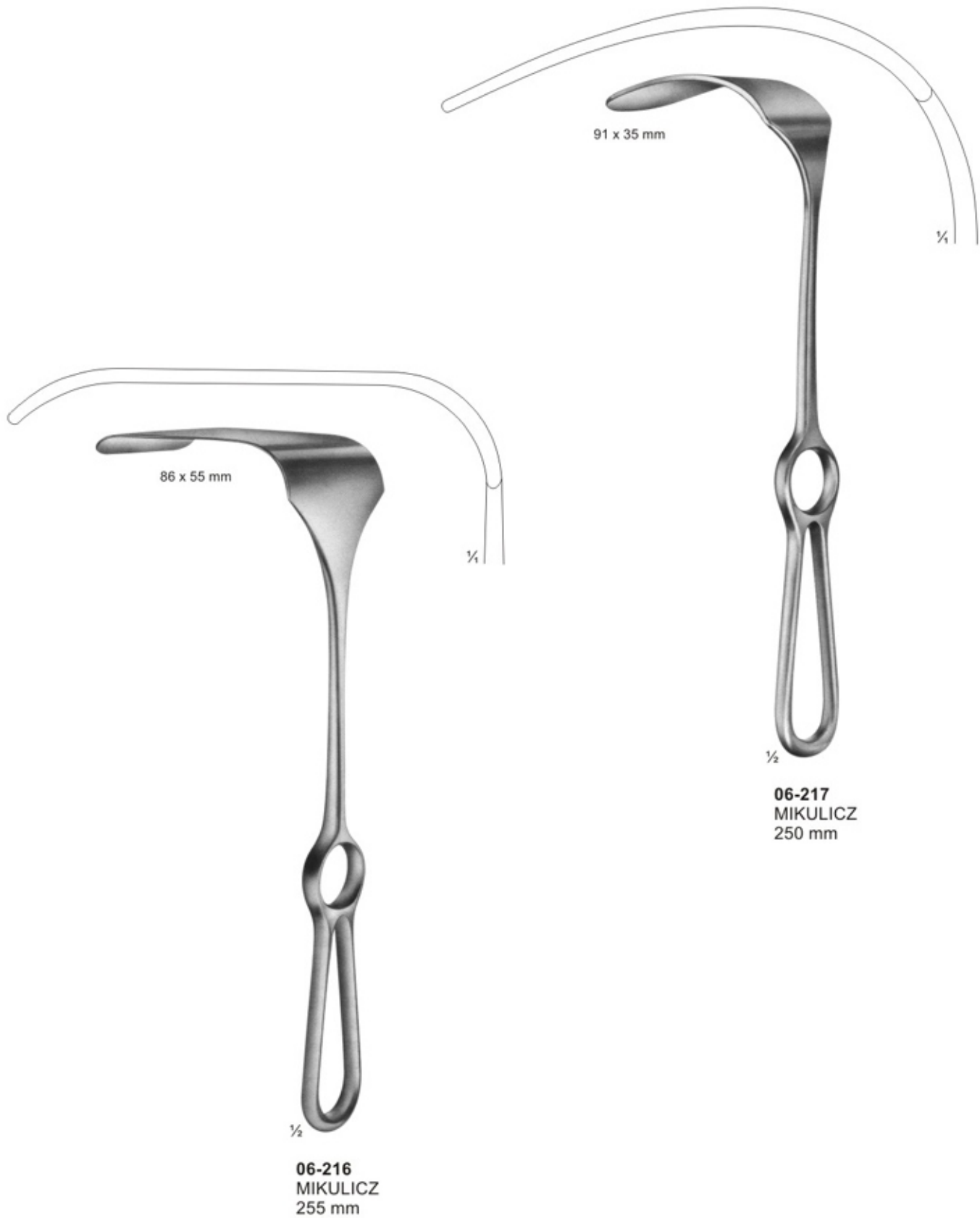

Retractors, Abdominal Retractors



- 06-229 Fig.1 32 x 40 mm
- 06-230 Fig.2 34 x 50 mm
- 06-231 Fig.3 41 x 60 mm
- 06-232 Fig.4 46 x 75 mm
- 06-233 Fig.5 64 x 85 mm

06-218 - 06-228
DOYEN
240 mm

06-229 - 06-233
FRITSCH
240 mm

06-234
DOYEN
250 mm

width of blades	35 mm, 45 mm, 60 mm
length of blades	
62 mm	06-218 , 06-222 , 06-226
92 mm	06-219 , 06-223 , 06-227
122 mm	06-220 , 06-224 , 06-228
160 mm	06-221 , 06-225

Abdominal- and Intestinal Spatulas Bauch- und Darmspatel



06-235
LERICHE
255 mm

06-236
KUMMEL
Mealleable
285 mm

06-237
MIKULICZ
29 mm
250 mm

06-238 - 06-239
KADER
06-238 30 mm
06-239 40 mm
270 mm

Self-Retaining Retractors

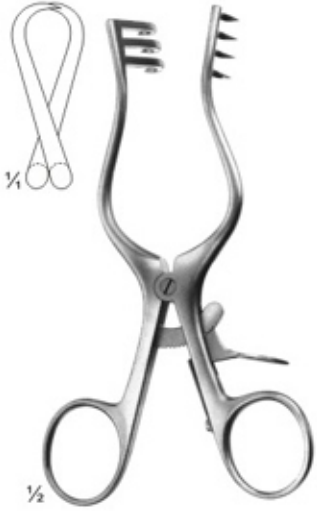

06-240
WEITLANER
sharp
130 mm

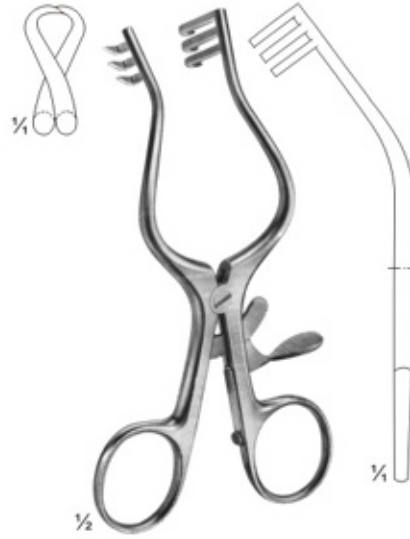

06-241
WULLSTEIN
sharp
130 mm

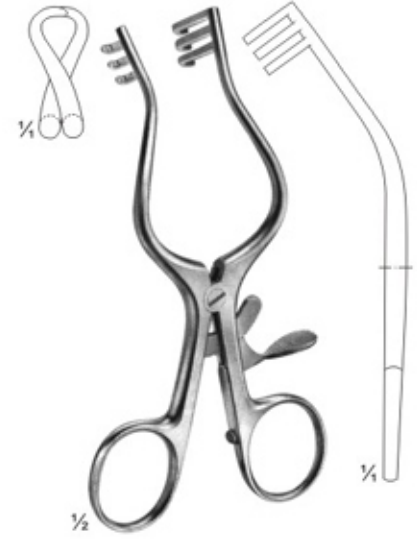

06-242
WULLSTEIN
blunt
130 mm



06-243
WEITLANER
sharp
165 mm



06-244
PLESTER
blunt
110 mm



06-245
PERKINS
130 mm

Special Retractors



06-246
JOLL (FRIEDMAN)
 Thyroid- and vaginal retractor
 155 mm

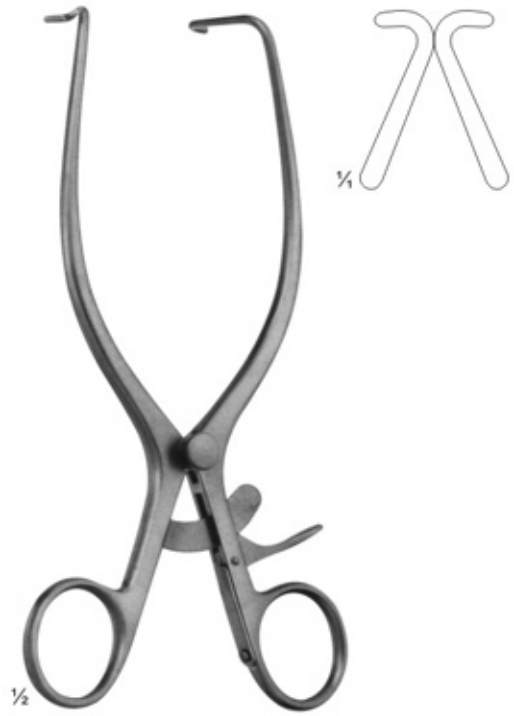

06-247
JACKSON BURROWS
 Retractor, blunt
 185 mm



06-248
GELPI
 Vaginal retractor
 135 mm

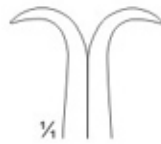

06-249
GELPI
 Skin- and vaginal retractor
 175 mm

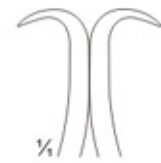

06-250
DE BAKEY
 Femur retractor
 145 mm

Lamina Spreaders



06-251
CLOWARD
155 mm



06-252
CLOWARD
135 mm



06-253
INGE
170 mm

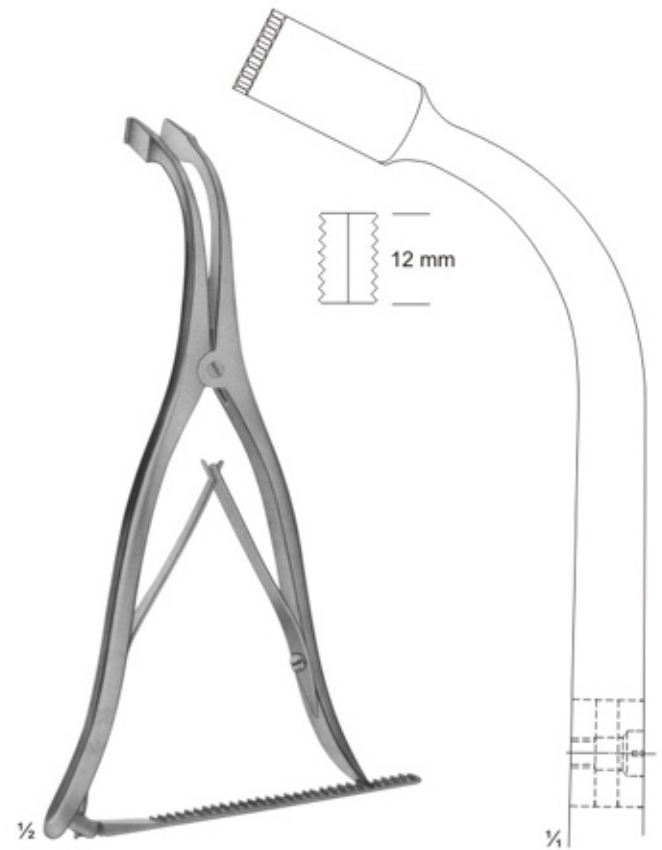

06-254
INGE
275 mm

Abdominal Retractors



06-255
GOSSET
Blades:38 mm deep

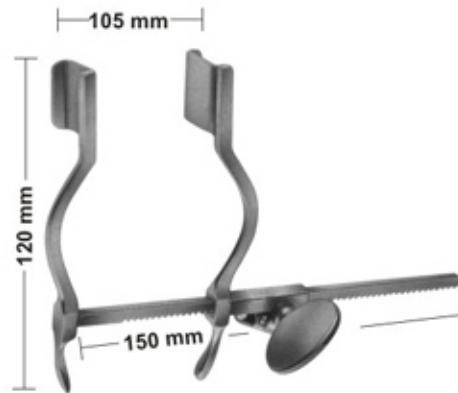

06-256
HERTZLER
Blades 20 X 25 mm

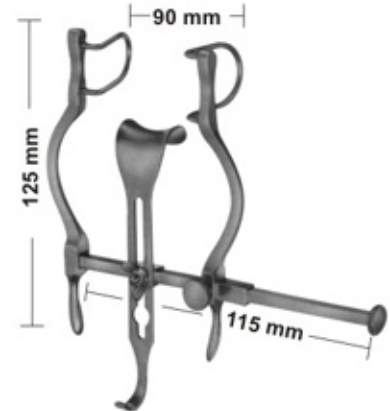

06-257
BALFOUR-BABY
Lateral blades 27 mm deep
Center blade 21x24 mm

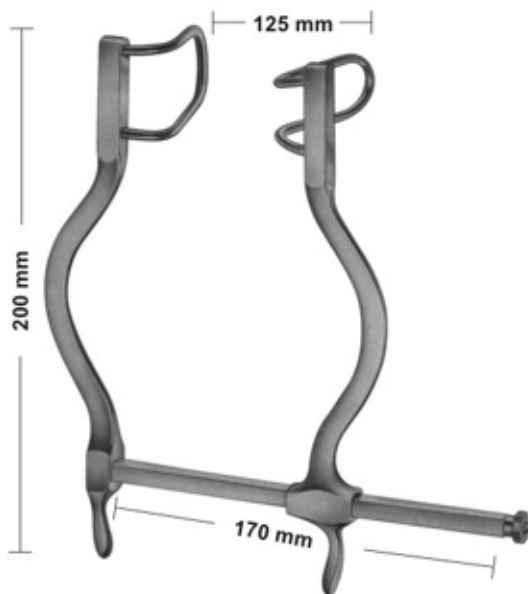

06-258
GOSSET
Blades:55mm deep

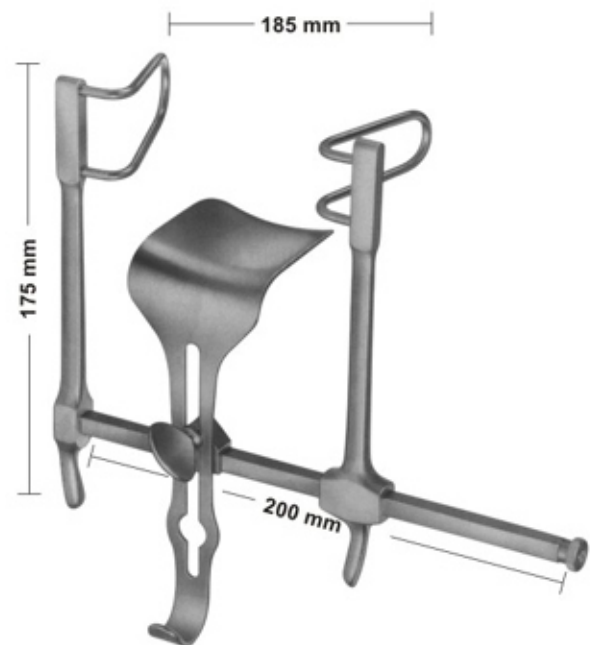

06-259
GOSSET
Lateral blades 58 mm deep
Center blade 59 x 57 mm

Abdominal Retractors

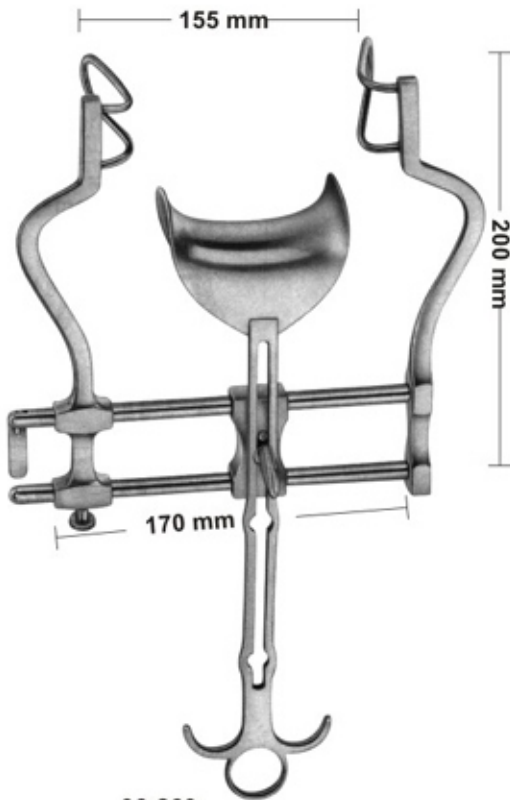

06-260
BALFOUR
Lateral blades 60 mm deep
Center blade 47 x 80 mm

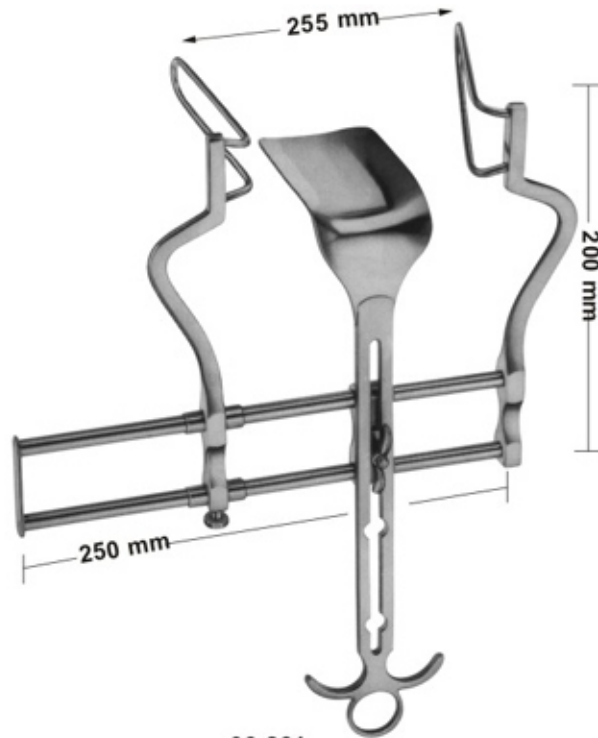

06-261
BALFOUR
Lateral blades 105 mm deep
Center blade 107x 59 mm



06-262
Center blade only
54x80 mm

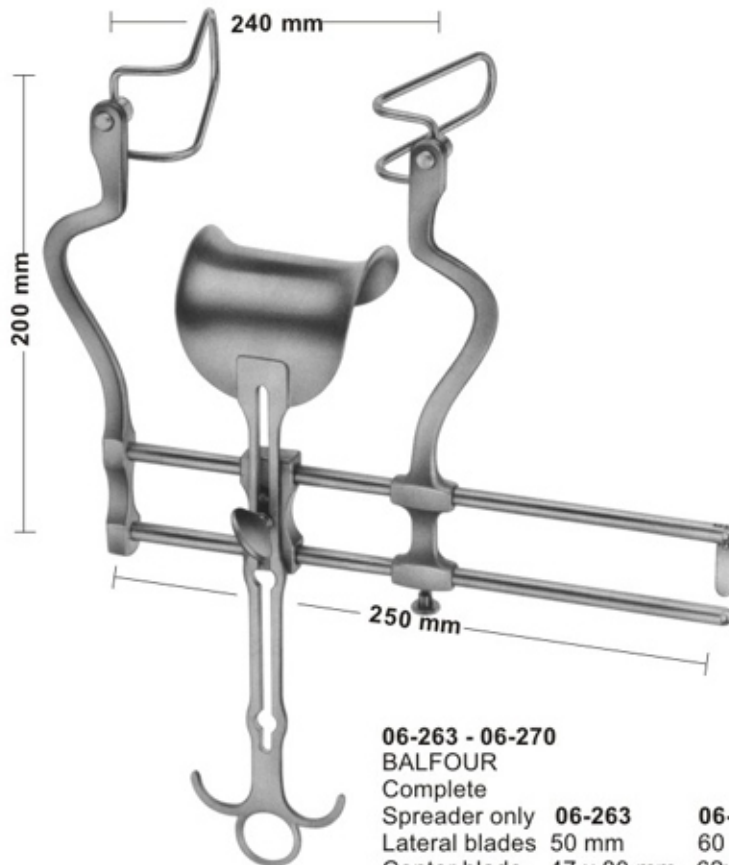

06-263 - 06-270
BALFOUR
Complete

Spreader only	06-263	06-264	06-265	06-266
Lateral blades	50 mm	60 mm	75 mm	90 mm
Center blade	47 x 80 mm	62x76 mm	80x80 mm	80x80 mm



Lateral blades
06-267 50 mm deep
06-268 60 mm deep
06-269 75 mm deep
06-270 90 mm deep
 Sales Unit of blades: PR = pair

Organ-, Tissue and Intestinal Grasping Forceps

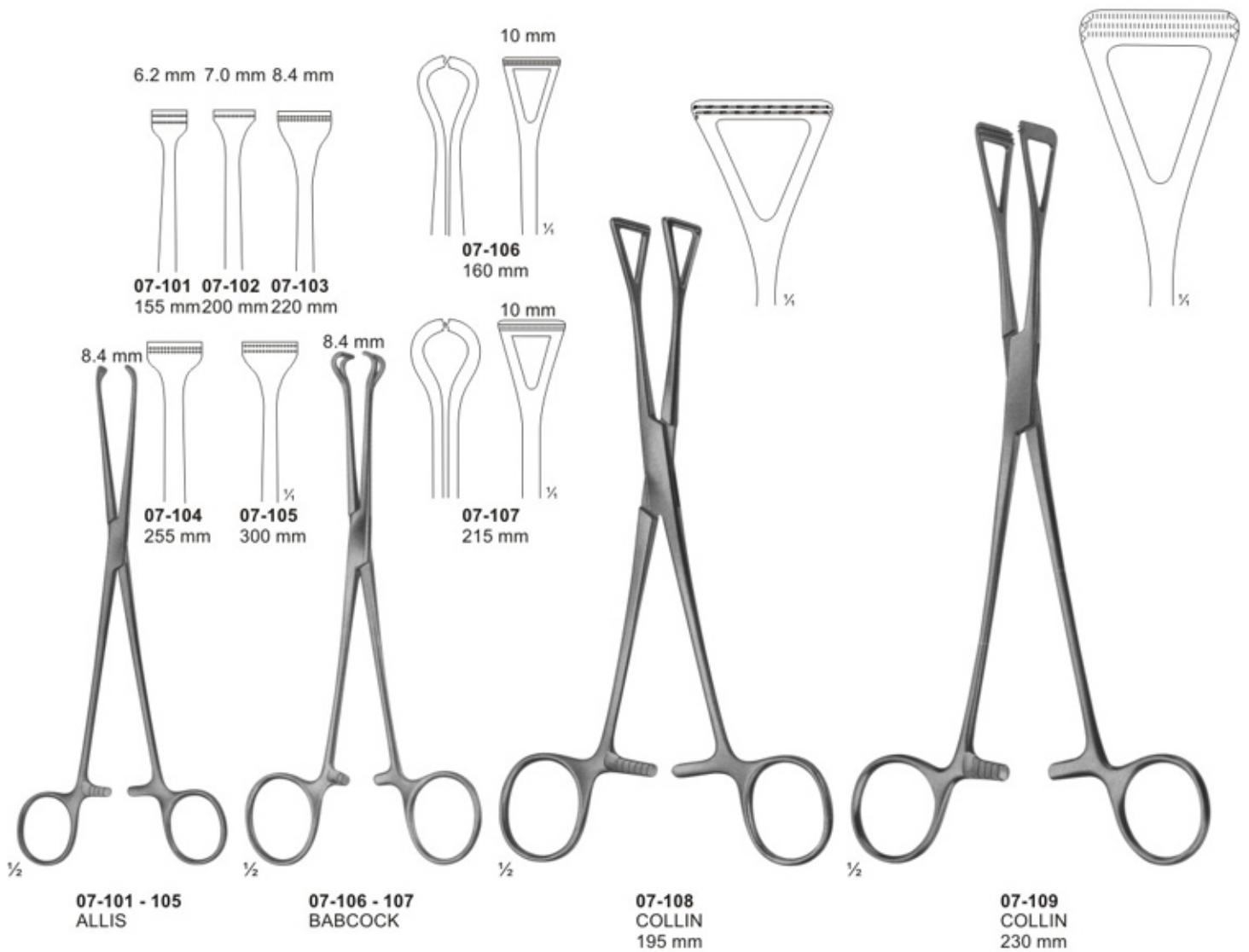

Intestinal Clamps, soft elastic

ATRAUMATA

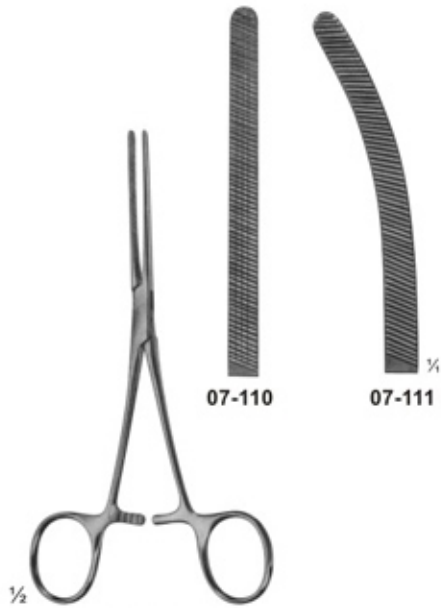

½
07-110 - 111
DOYEN
elastic
165 mm

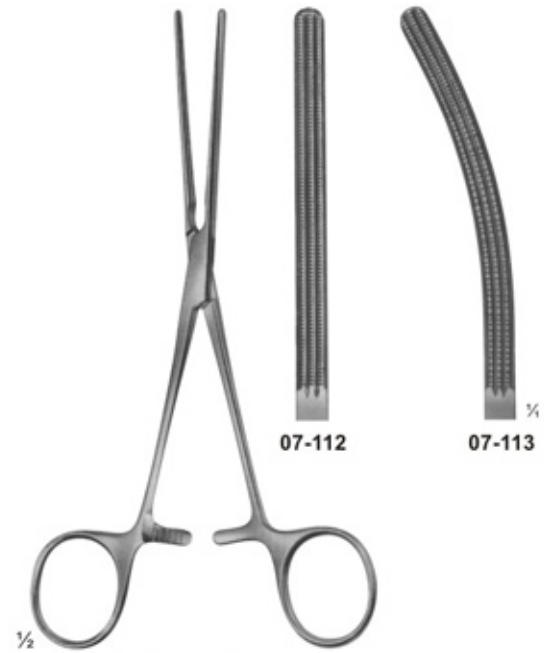

½
07-112 - 113
DOYEN
with elastic blades
170 mm

ATRAUMATA

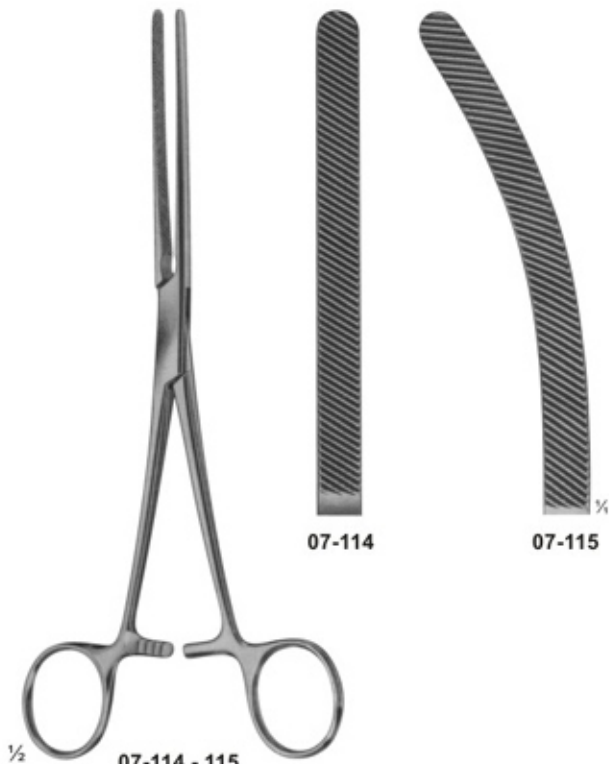

½
07-114 - 115
HARTMANN
with elastic blades
200 mm

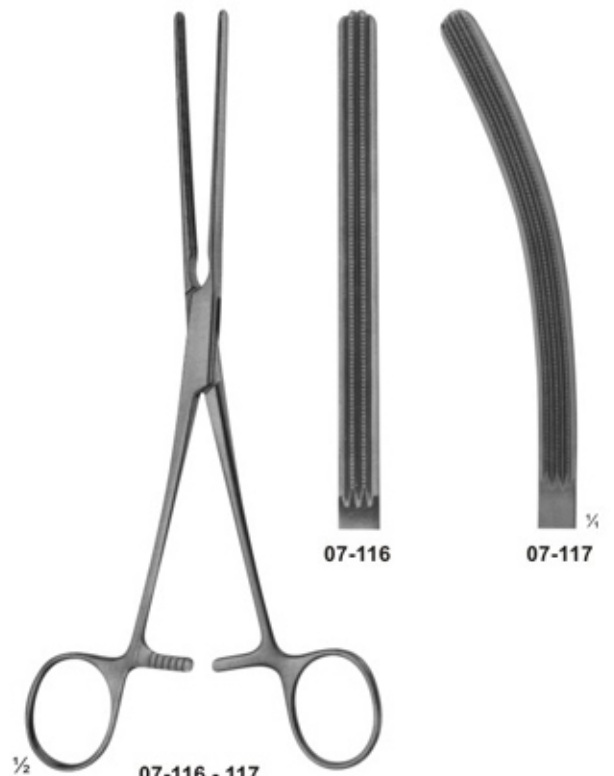

½
07-116 - 117
HARTMANN
with elastic blades
200 mm

Intestinal and Pylorus Clamps



1/2
07-118
 PAYR
 Intestinal clamp
 light pattern,
 for children
 180 mm

1/2
07-119
 PAYR
 200 mm

1/2
07-120
 PAYR
 275 mm

1/2
07-121
 PAYR
 Pylorus clamp
 315 mm

ATRAUMATA Sigmoid Anastomosis Forceps

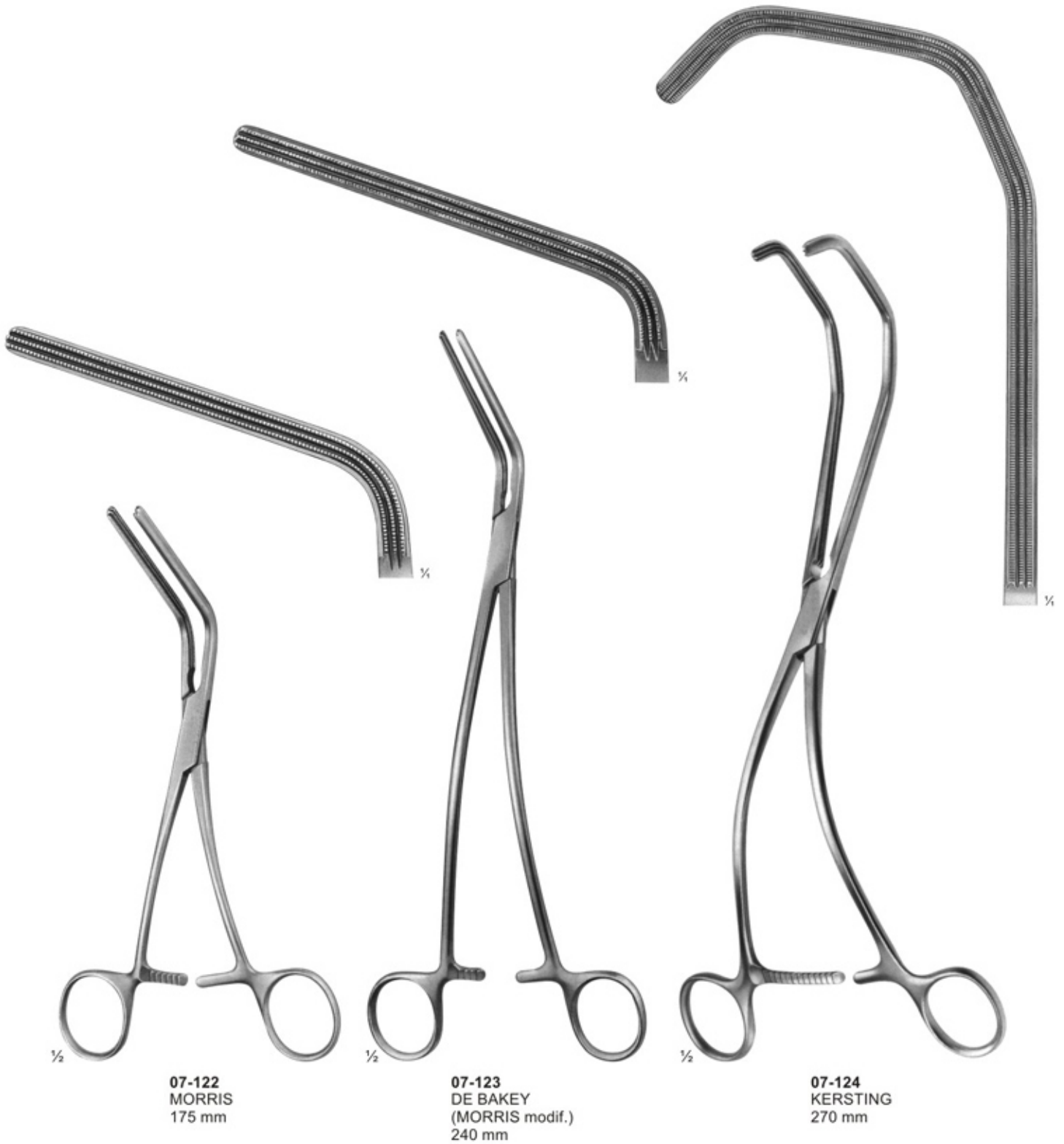

Nasal Specula



08-101
Martin
13 cm / 5 1/8"



08-102
SIMS
160 mm

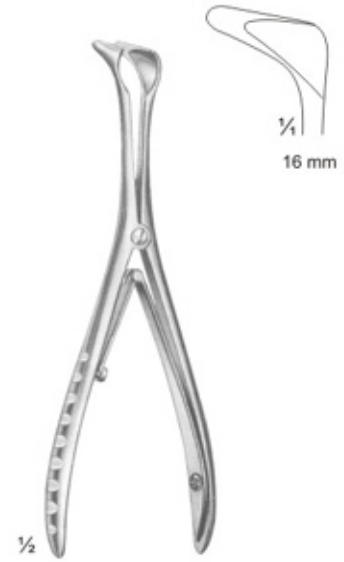

08-103
Tieck-Halle
13 cm / 5 1/8"



08-104
Killian

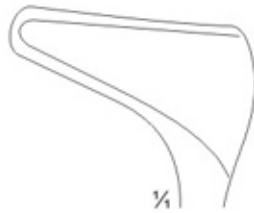

Fig. 1
14 cm 5 4/8"
35 mm

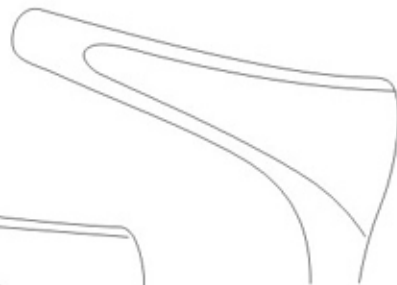

Fig. 2
14,5 cm / 5 4/8"
50 mm

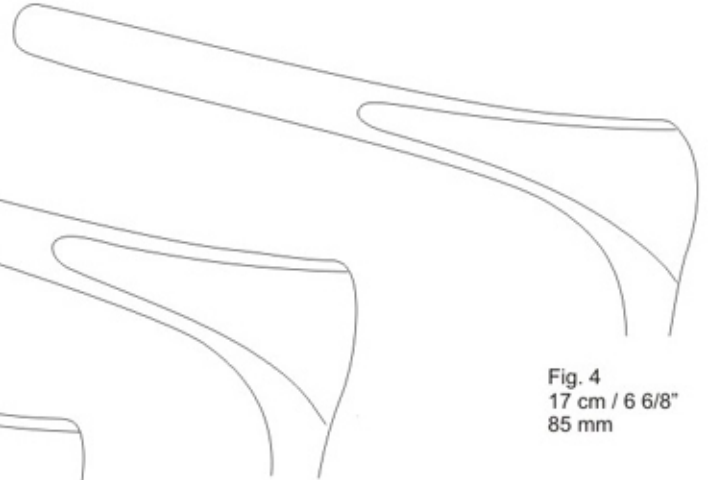

Fig. 3
16 cm / 6 2/8"
75 mm

Fig. 4
17 cm / 6 6/8"
85 mm

Nasal Specula



08-105
Cottle

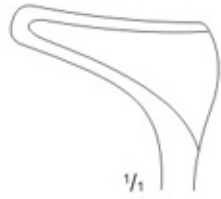

Fig. 1
13,5 cm / 5 3/8"
35 mm

1/1

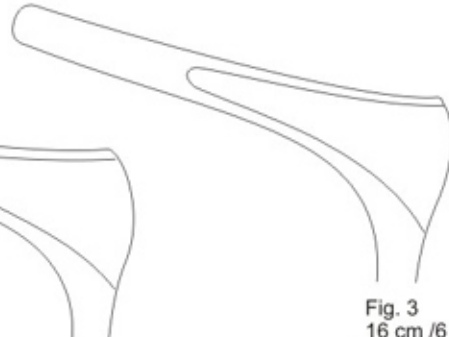

Fig. 2
14 cm / 5 4/8"
50 mm

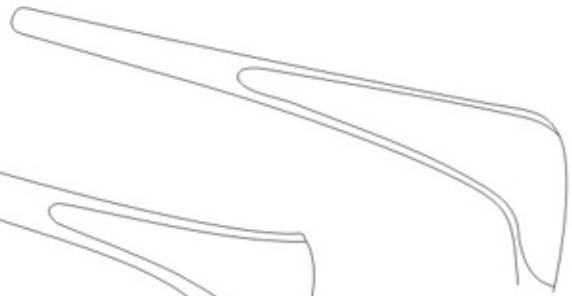

Fig. 3
16 cm / 6 2/8"
75 mm

Fig. 4
16 cm / 6 2/8"
85 mm



08-106
Goldsmith (Thudichum)
6,5 cm / 2 4/8"



Fig. 1
21,0 x 9,5 mm



Fig. 2
21,0 x 10,5 mm



Fig. 3
21,0 x 11,5 mm



08-107
Mod. Wien 2
13,5 cm / 5 7/8"



Fig. 1
30 mm

1/1



08-108
Hartmann-Halle
16 cm / 6 7/8"



Fig. 1
27 mm



Fig. 2
31 mm

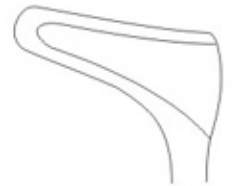

Fig. 3
35 mm

Anuscopy-Sphincteroscopes



08-109
IVES-FANSLER
Anuscopy
145 mm
Ø24mm



08-110
KELLY
Sphincteroscope
160 mm
Ø21mm



08-111
KELLY
Sphincteroscope
160 mm
Ø27mm

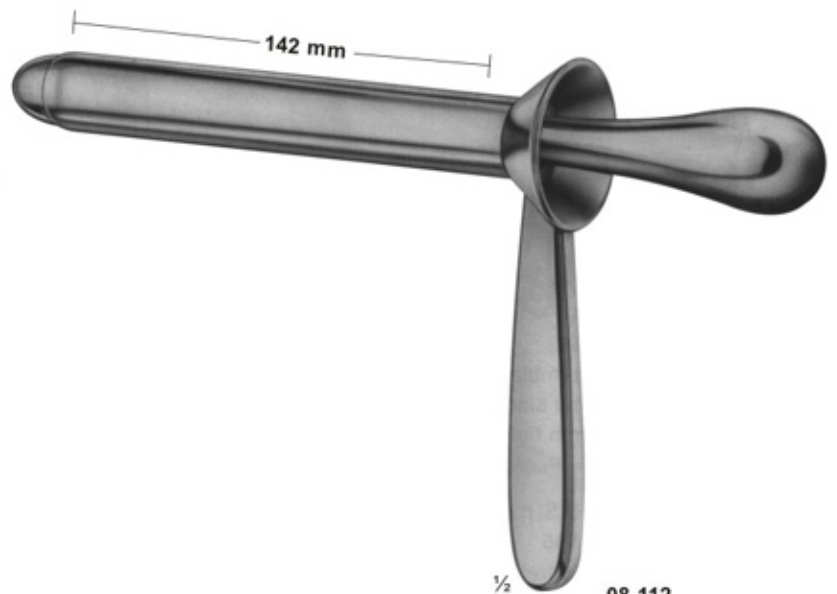

08-112
KELLY
Proctoscope
140 mm
Ø22mm

Haemorrhoidal Forceps

ATRAUMATA

Pressure Clamp

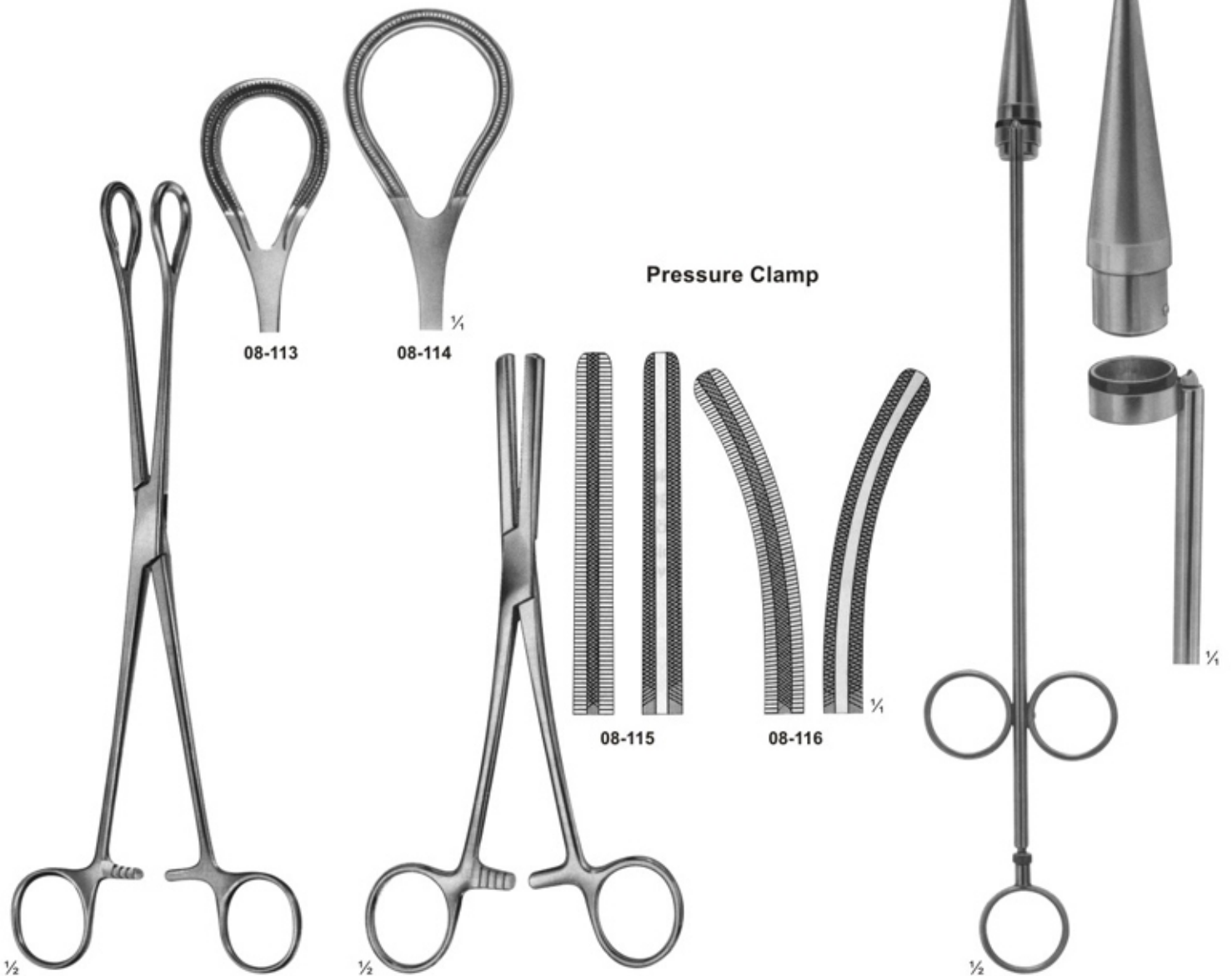

08-113 - 08-114
 250 mm
 08-114
 270 mm

08-115 - 08-116
FERGUSSON
 200 mm

08-117
RUDD
 Haemorrhoidal ligator
 with loading
 attachment and 100
 ligature rubber rings
 315 mm

Gall Duct Forceps



08-118
LOWER
180 mm



08-119
LAHEY (SWEET)
190 mm



08-120
LAHEY
220 mm



08-121
DESJARDINS
Gall duct-and cystic forceps
210 mm



08-122
NISSEN
Gall duct-and cystic forceps
215 mm

Gall Duct Dilators and Gall Stone Scoops

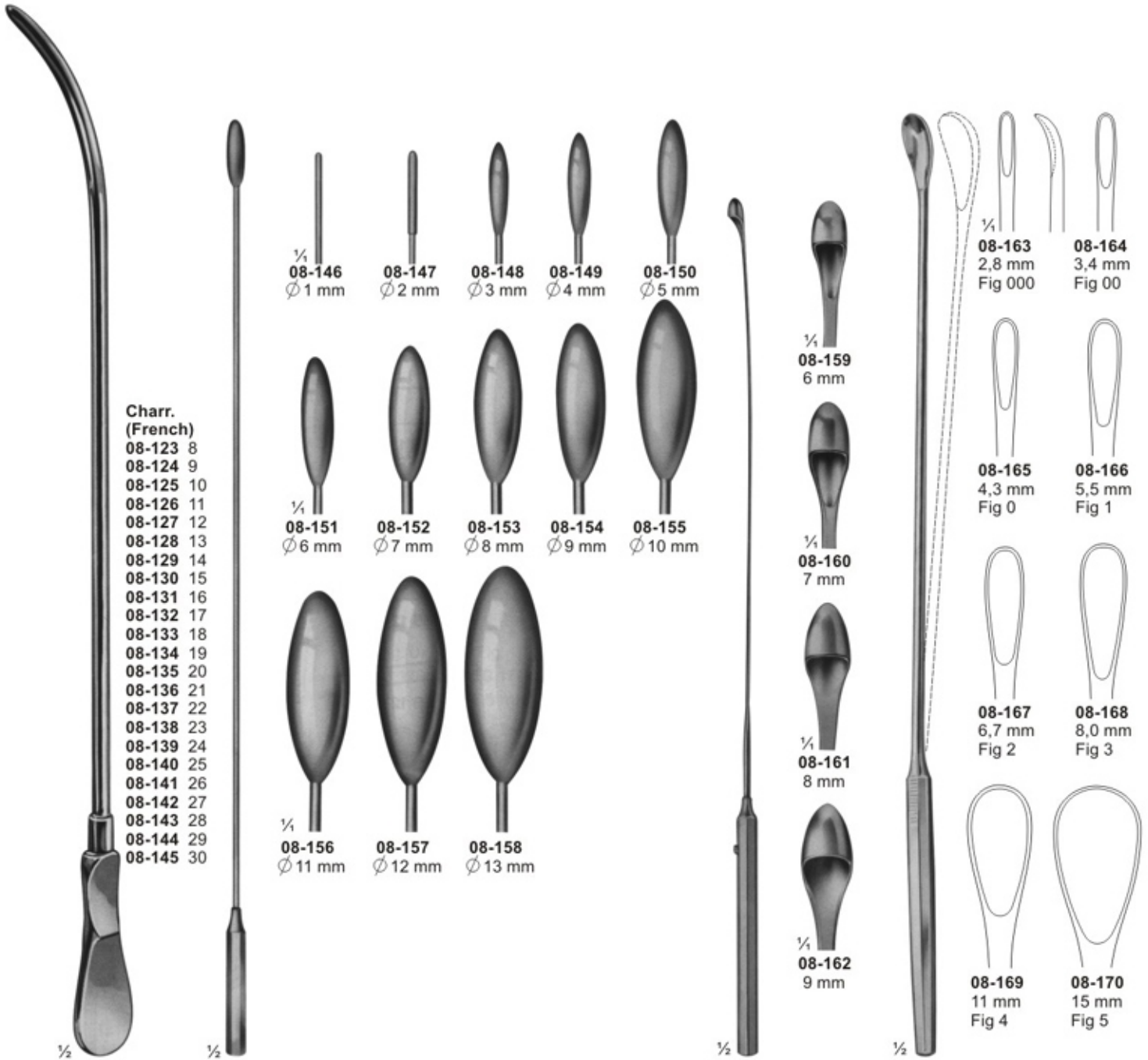

08-123 - 08-145
DITTEL
Metall bougies and dilating sounds, stiff
345 mm

08-146 - 08-158
BAKES
Common bile duct dilators, malleable
08-146 - 08-150 315 mm
08-151 - 08-158 320 mm

08-159 - 08-162
DESJARDINS
Probe and catch with flexible shaft
300 mm

08-163 - 08-170
LUER-KOERTE modif with malleable shaft
310 mm

Gall Stone Forceps

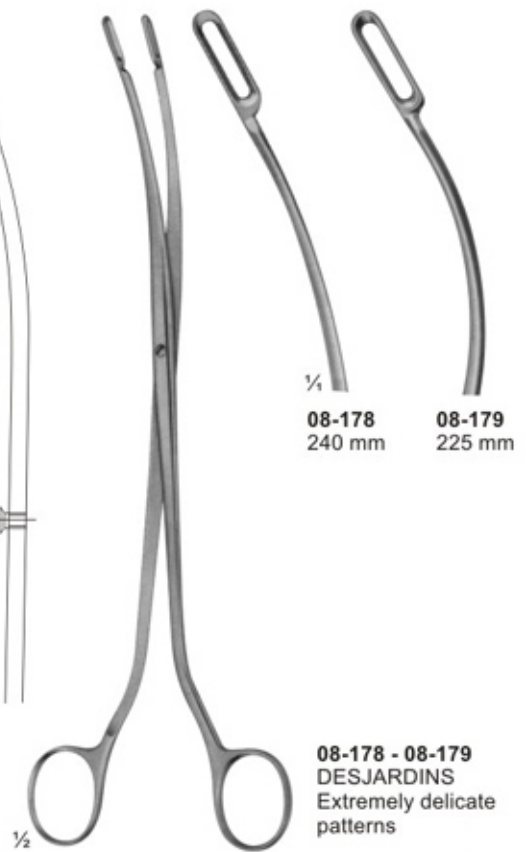
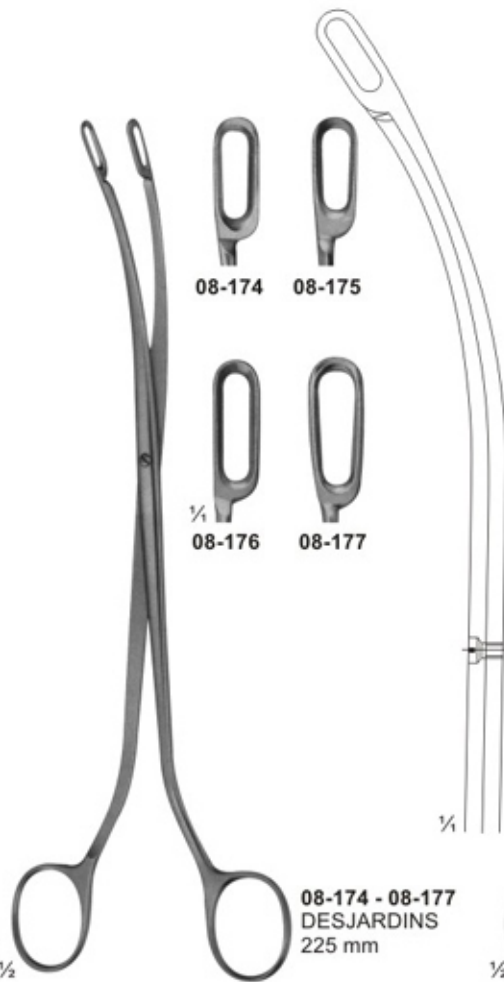
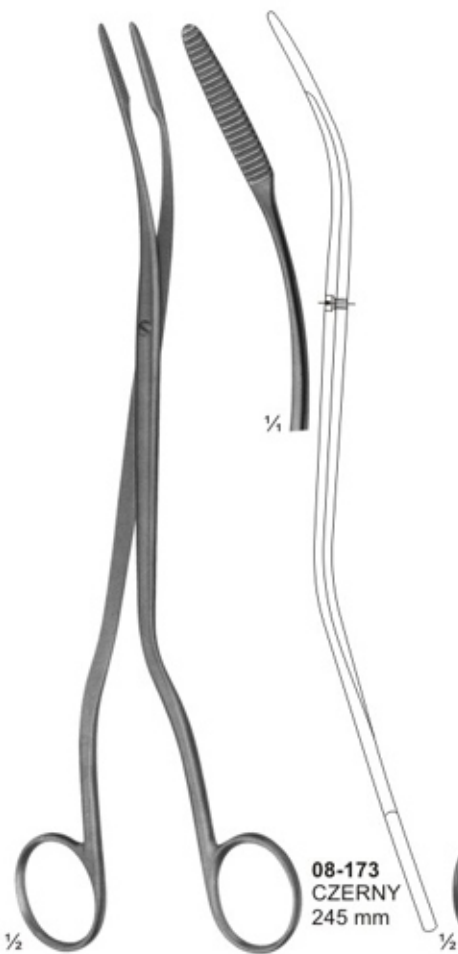
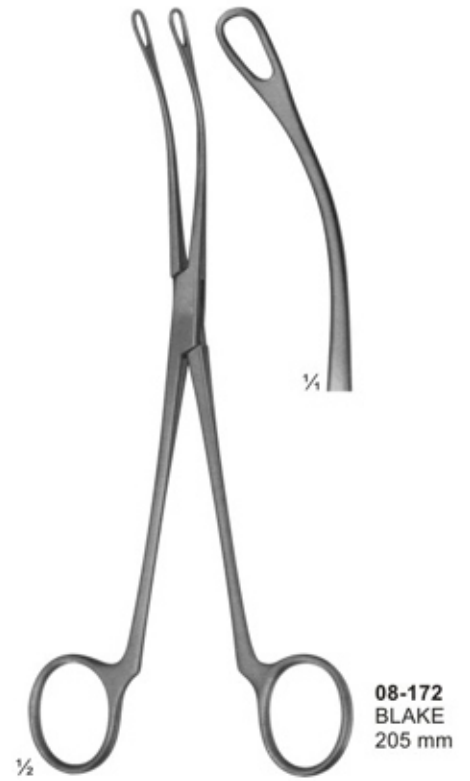

Kidney Clamps

ATRAUMATA

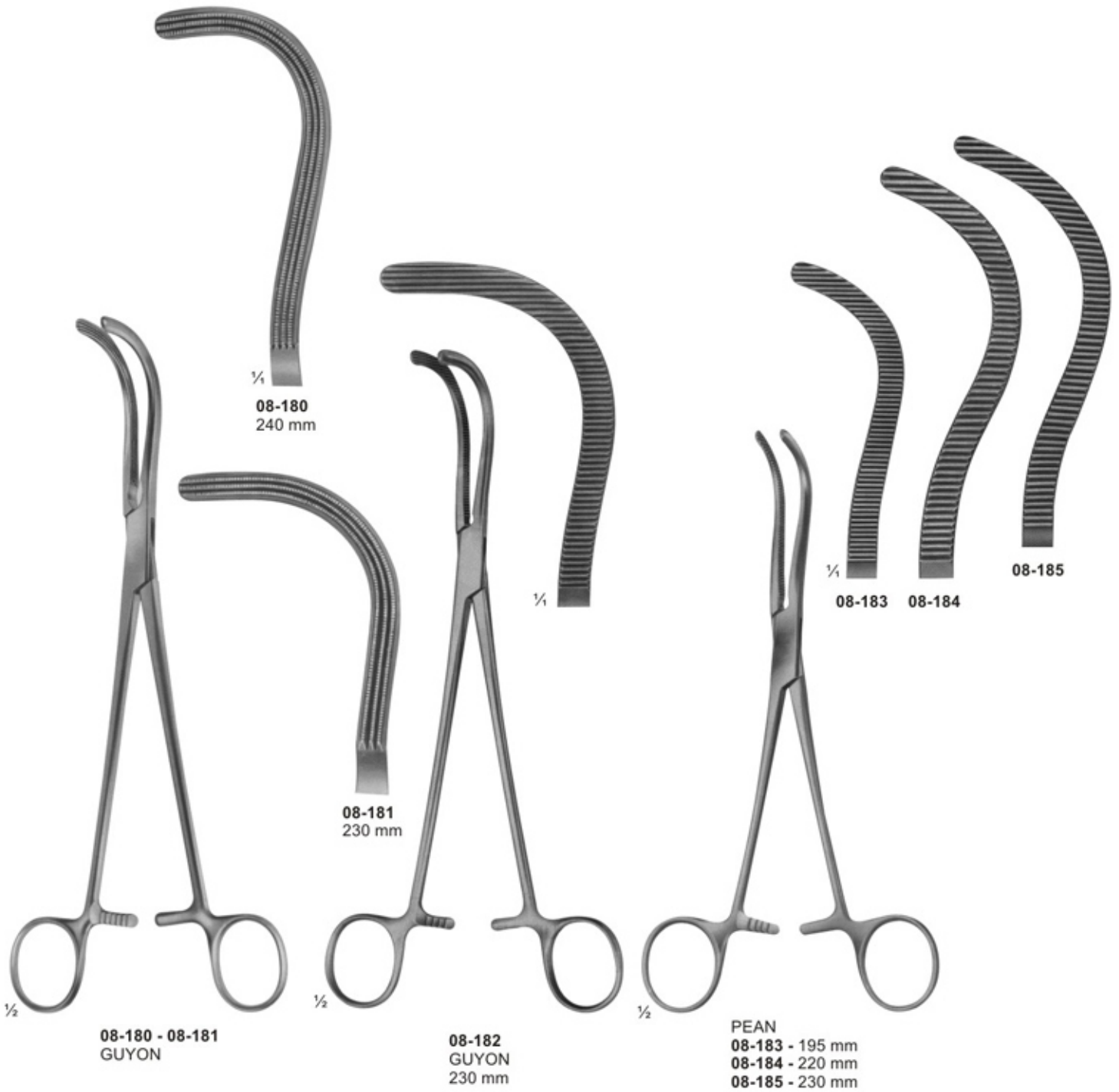

Kidney Stone Forceps



08-186



08-187



08-188



$\frac{1}{4}$
08-189



08-190



08-191



$\frac{1}{4}$
08-192



$\frac{1}{2}$

08-186 - 08-189
RANDALL
225 mm



$\frac{1}{2}$

08-190 - 08-192
RANDALL
190 mm

Bladder Retractors

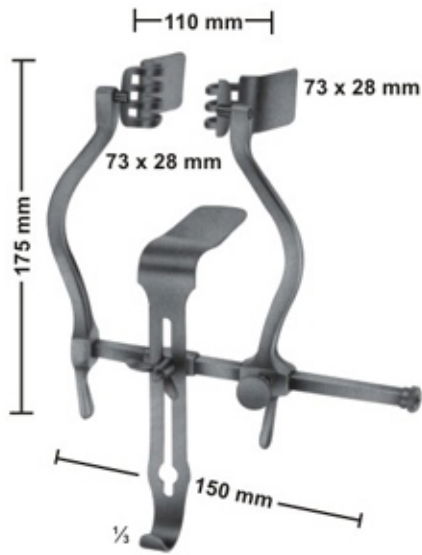

09-101
JUDD-MASSON
 Bladder-and suprapubic retractor

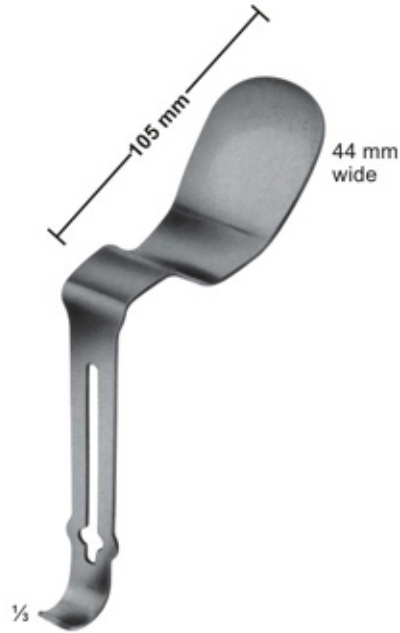

09-102
MILLIN
 Center bladder for retro pubic prostatectomy



09-103
MILLIN
 Bladder retractor, complete
 105X45 mm



09-104
LEGUEU
 Bladder retractor
 Center blade
 80 x 31 mm



09-105
KOCHER
 Bladder spatula
 235 mm

Trocars



09-106
KLIMA ROSEGGER
35 X 1,8 mm
Sternal puncture needle



09-107
Universal trocar
with 4 tips



NELSON



09-108 - 112
Inside diam. Outside diam
09-108 2,2 mm 3,0 mm
09-109 3,0 mm 4,0 mm
09-110 4,0 mm 5,0 mm
09-111 5,0 mm 6,0 mm
09-112 5,5 mm 6,5 mm
for hydrocele and abdominal puncture

09-113 - 116
Inside diam. Outside diam
09-113 2,2 mm 3,0 mm
09-114 3,0 mm 4,0 mm
09-115 4,0 mm 5,0 mm
09-116 5,0 mm 6,0 mm
for abdominal puncture,
with stop-cock and lateral
drain



09-117 - 118
Inside diam. Outside diam
09-117 6,5 mm 8,0 mm
09-118 9,0 mm 10,0 mm
Erapyema trocar
BUELEU

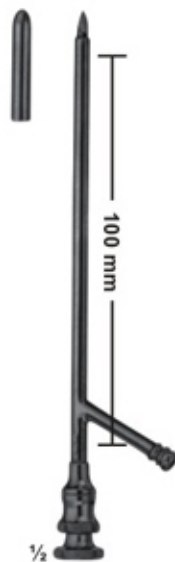

09-119 - 122
Inside diam. Outside diam
09-119 3,0 mm 4,0 mm
09-120 3,6 mm 4,6 mm
09-121 4,3 mm 5,3 mm
09-122 5,0 mm 6,0 mm
Gall bladder trocars OCHSNFR



09-123
PIERCE
Antrum trocar
Ø 4,0 mm



09-124
COAKLEY
Antrum trocar
3,0 mm

Vaginal Specula

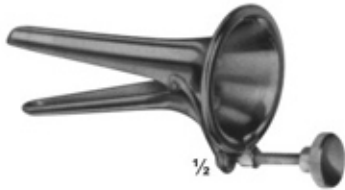

10-101
COLLIN
for children
53 x 10 mm

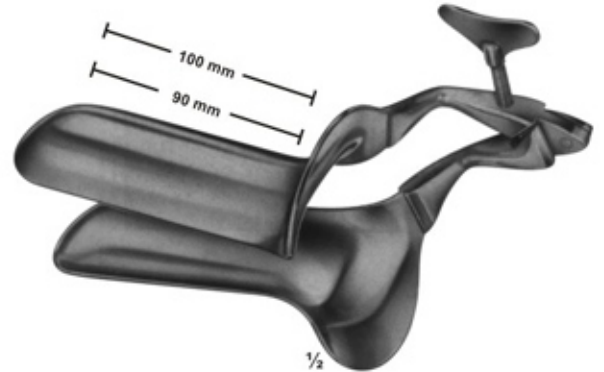

10-102 - 105
COLLIN

10-102	100/90mm	28 mm
10-103	100/90mm	32 mm
10-104	105/95mm	35 mm
10-105	115/105mm	40 mm

 Total length/working length width



10-106
COLLIN
for virgins
95/85 x 18 mm



10-107
CUSCO
for virgins
75 x 17 mm



10-108
CUSCO
for virgins
75 x 17 mm

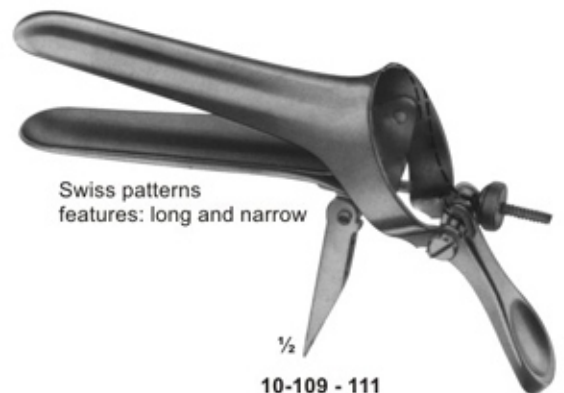

Swiss patterns
features: long and narrow

10-109 - 111
CUSCO

10-109	92X23-25 mm
10-110	100x25-27 mm
10-111	110x27-30 mm

Vaginal Specula- Sets, upper and lower blades



10-112 - 114
GRAVE
10-112 75X20 mm
10-113 95X30 mm
10-114 105X33 mm

½



10-115 - 116
PEDERSON
10-115 100X22 mm
10-116 120X25 mm

½



10-117 - 118
BRIESKY
10-117 72X25 mm / 77X30 mm 140 mm
10-118 75X30 mm / 92X38 mm 170 mm

½



10-119
SIMS
70 X 26 mm / 75 X 30 mm
75 X 30 mm / 80 X 35 mm
80 X 36 mm / 90 X 40 mm
175 mm

½



10-120 - 122
SEIDL
10-120 80X8 mm
10-121 80X10 mm
10-122 90X14 mm
For children and infants
170 mm

½



10-123
KRISTELLER
70X15 mm, (170 mm)
For children

½



10-124 - 10-126
KRISTELLER
10-124 70X27 mm
10-125 75X30 mm
10-126 90X36 mm
175 mm

½

Vaginal Specula- upper and lower blades



10-127 - 131
KRISTELLER
 10-127 110X18 mm
 10-128 110X20 mm
 10-129 110X27 mm
 10-130 110X30 mm
 10-131 110X36 mm
 220 mm

10-132 - 10-135
KRISTELLER
 Upper blades

10-136 - 10-139
KRISTELLER
 Lower blades

Vaginal Specula



Vaginal Retractors



1/2
10-154
JOLL (FRIEDMAN)
155 mm



1/2
10-155
RICHTER
170 mm



1/2
10-156
GELPI
135 mm



1/2
10-157
GELPI
175 mm

Uterine Dilators



½

11-101 - 143
HEGAR
with very conical point
185 mm

11-101	1	mm	11-123	23	mm
11-102	2	mm	11-124	24	mm
11-103	3	mm	11-125	25	mm
11-104	4	mm	11-126	26	mm
11-105	5	mm	11-127	1	½mm
11-106	6	mm	11-128	2	½mm
11-107	7	mm	11-129	3	½mm
11-108	8	mm	11-130	4	½mm
11-109	9	mm	11-131	5	½mm
11-110	10	mm	11-132	6	½mm
11-111	11	mm	11-133	7	½mm
11-112	12	mm	11-134	8	½mm
11-113	13	mm	11-135	9	½mm
11-114	14	mm	11-136	10	½mm
11-115	15	mm	11-137	11	½mm
11-116	16	mm	11-138	12	½mm
11-117	17	mm	11-139	13	½mm
11-118	18	mm	11-140	14	½mm
11-119	19	mm	11-141	15	½mm
11-120	20	mm	11-142	16	½mm
11-121	21	mm	11-143	17	½mm
11-122	22	mm			



½

11-144 - 152
HEGAR
205 mm

11-144	1+2	mm
11-145	3+4	mm
11-146	5+6	mm
11-147	7+8	mm
11-148	9+10	mm
11-149	11+12	mm
11-150	13+14	mm
11-151	15+16	mm
11-152	17+18	mm

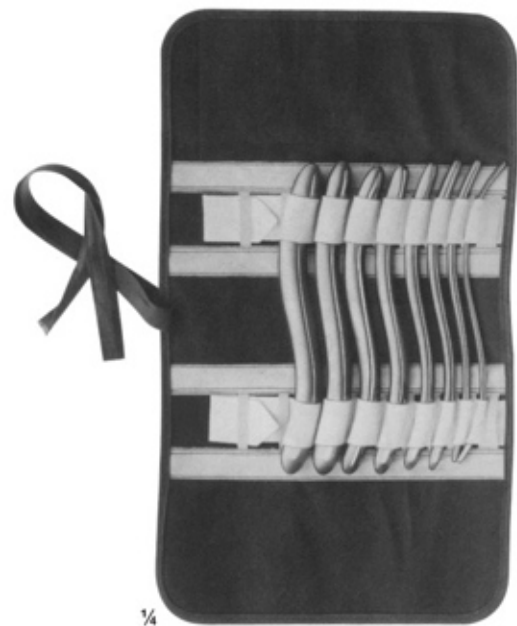

¼

11-153
HEGAR
Uterine dilator set, in canvas
roll with 8 dilators.

Uterine Probes

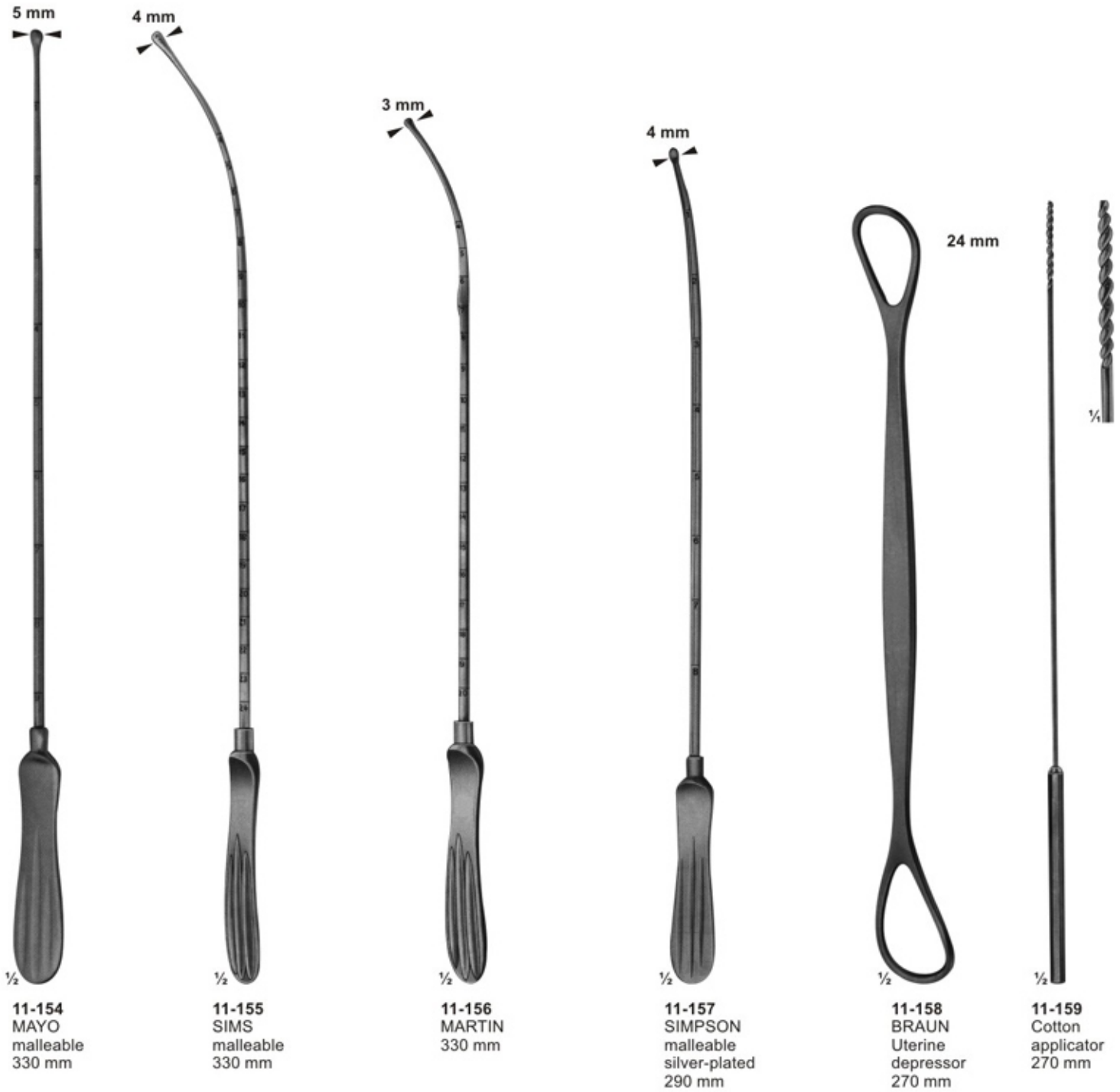

11-154
MAYO
malleable
330 mm

11-155
SIMS
malleable
330 mm

11-156
MARTIN
330 mm

11-157
SIMPSON
malleable
silver-plated
290 mm

11-158
BRAUN
Uterine
depressor
270 mm

11-159
Cotton
applicator
270 mm

Uterine Dressing Forceps



11-160
PELKMANN
260 mm



11-161
PELKMANN
260 mm



11-162
BOZEMANN
250 mm



11-163
BOZEMANN
255 mm

Jaws with longitudinal groove

Polypus-and Ovum Forceps

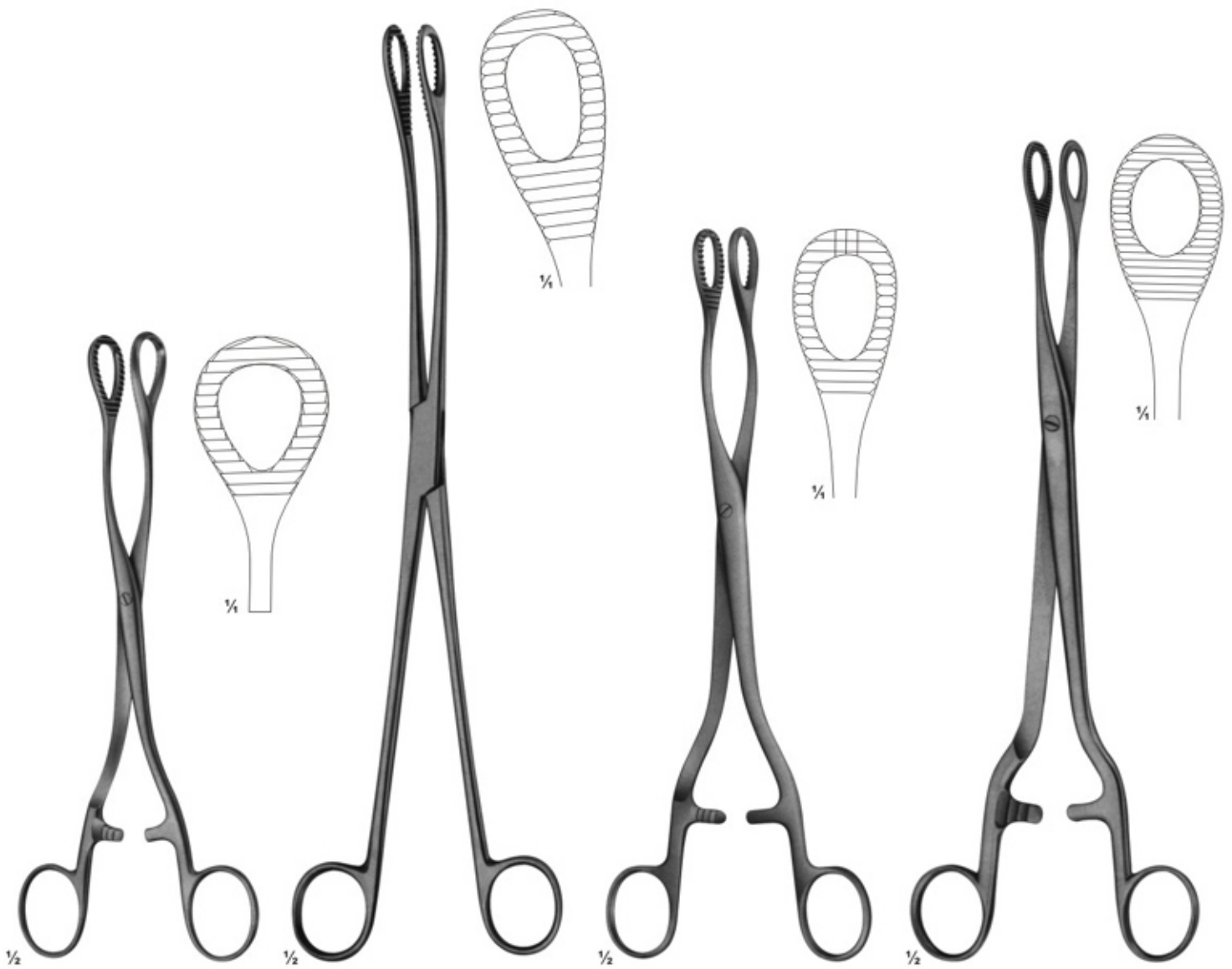

11-164
HEYWOOD-SMITH
200 mm

11-165
KELLY
320 mm

11-166
HEYWOOD-SMITH
250 mm

11-167
NOTO
280 mm

Ear Curettes



12-101
Langenbeck
13 cm / 5 1/8"

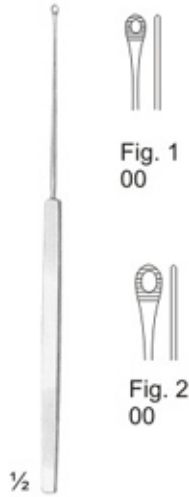

12-102
Shapleigh
15 cm / 5 1/8"

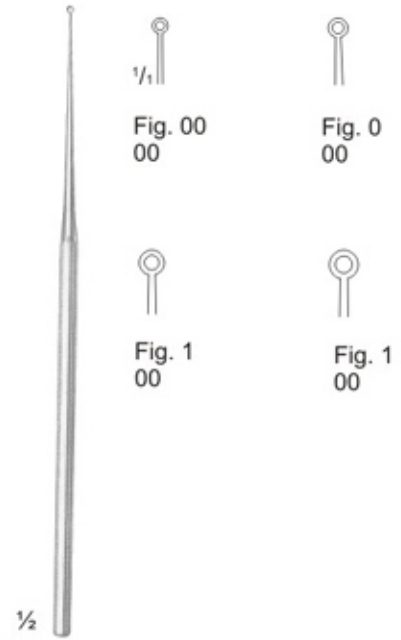

12-103
Buck
17cm / 6 6/8"



12-104
Buck
15 cm / 6 6/8"

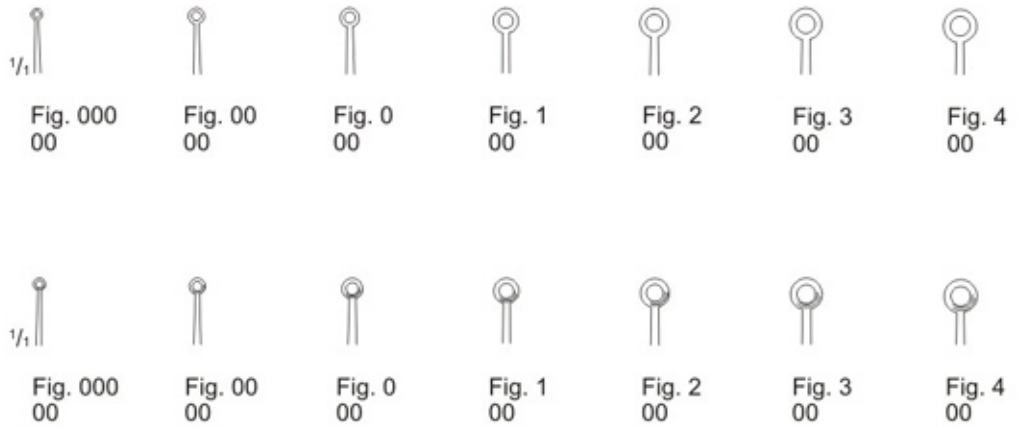

Biopsy Curettes

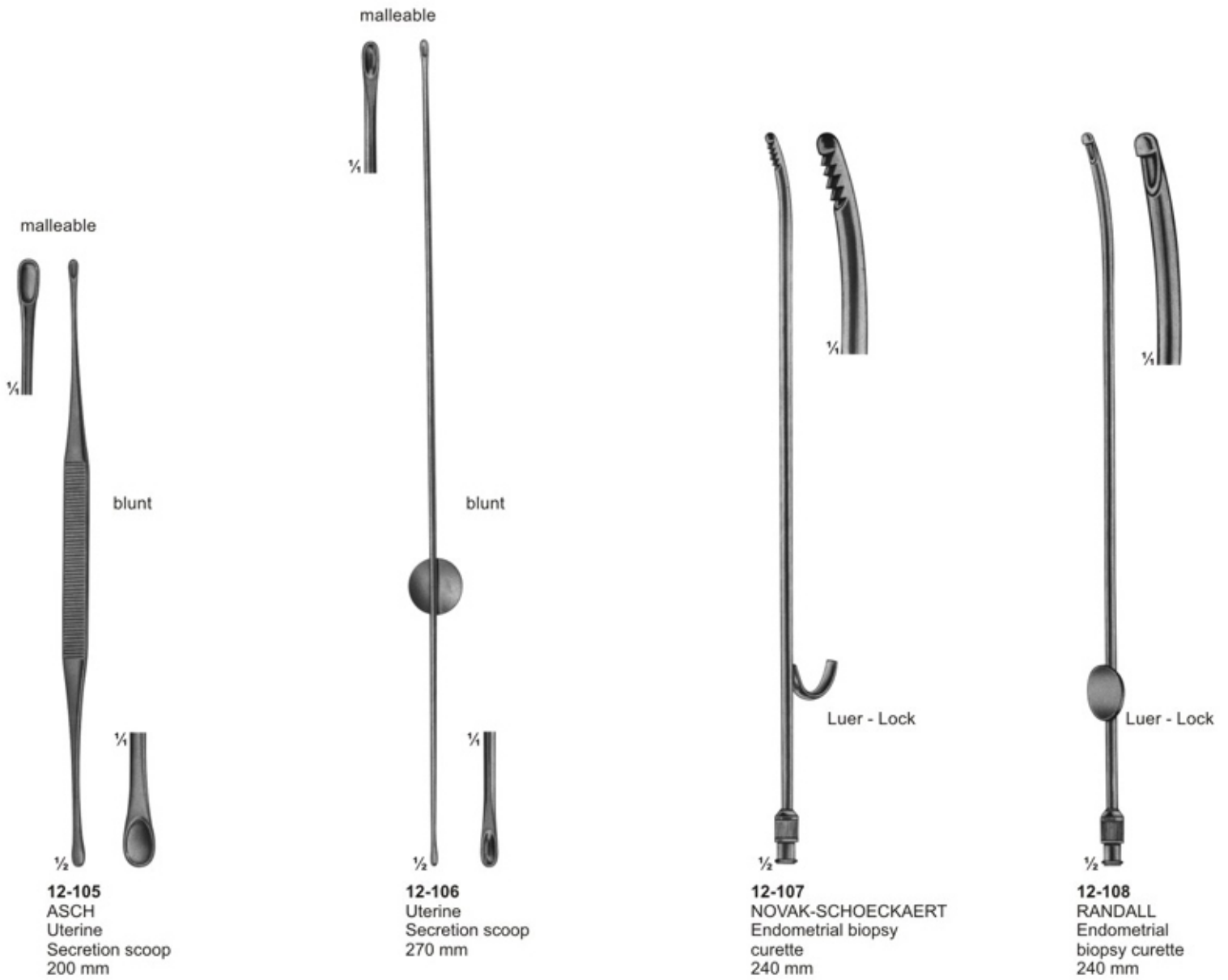

12-105
ASCH
Uterine
Secretion scoop
200 mm

12-106
Uterine
Secretion scoop
270 mm

12-107
NOVAK-SCHOECKAERT
Endometrial biopsy
curette
240 mm

12-108
RANDALL
Endometrial
biopsy curette
240 mm

Ear Polypus Forceps



12-109
Hartmann-Wullstein
shaft length
85 mm

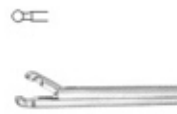

12-110
Hartmann-Wullstein
shaft length
85 mm



12-111
Hartmann
shaft length
85 mm



12-112
Hartmann
shaft length
85 mm

12-113
14 cm / 5 4/8"
shaft length
140 mm



12-109 - 12-119



12-114
Hartmann-Herzfelr
2,0 mm
shaft length
85mm



12-115
Hartmann
3 mm
shaft length
85mm

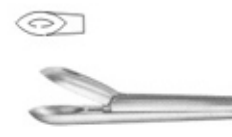

12-116
shaft length
85mm

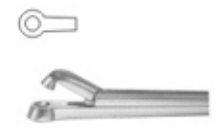

12-117
Hartmann-Hoffmar
2,0 mm
85mm

12-118
2,5 mm
85 mm

12-119
3,0 mm
85 mm

Biopsy forceps for rectum

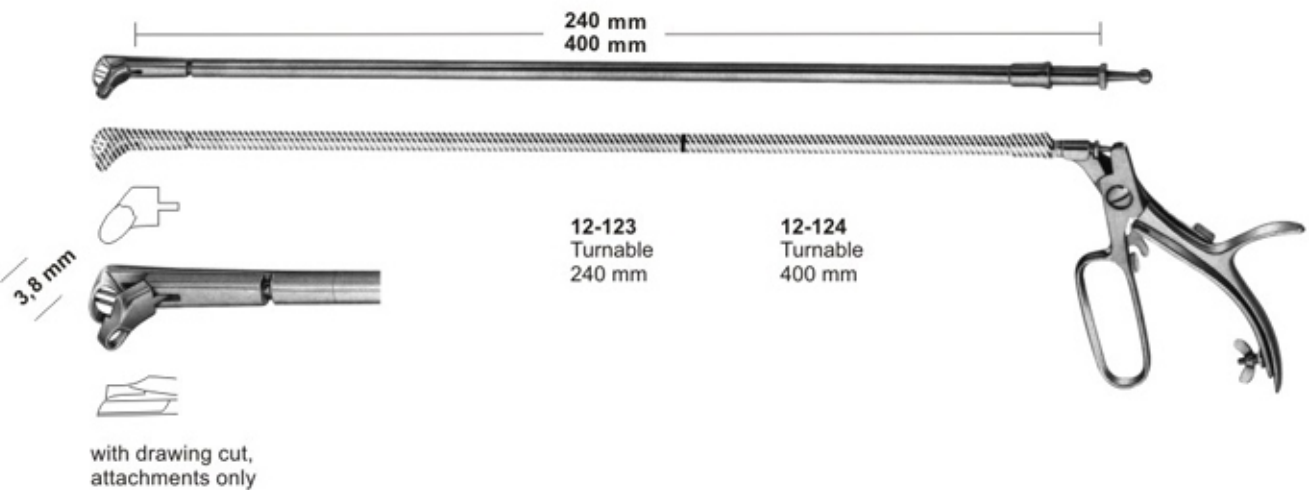
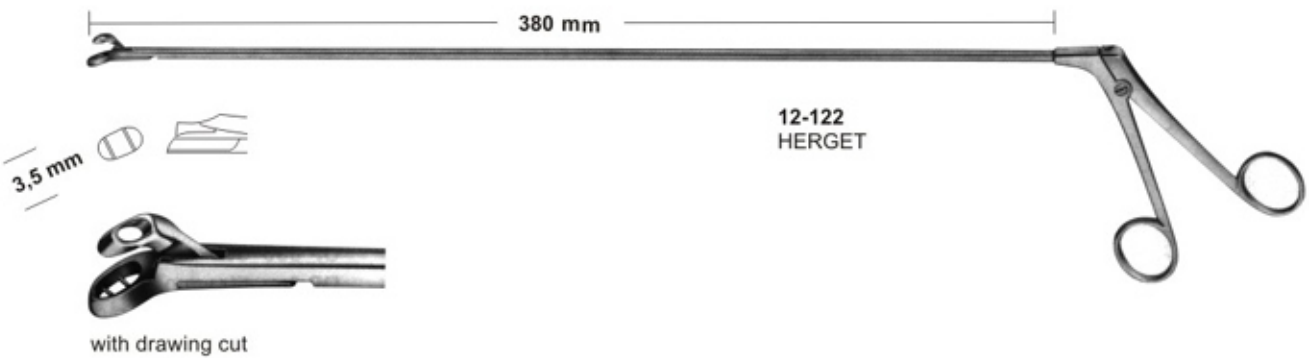
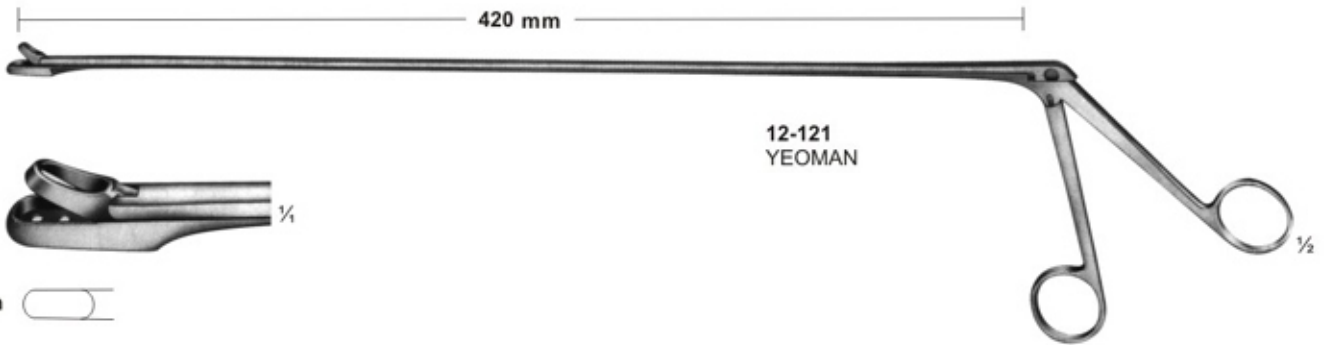
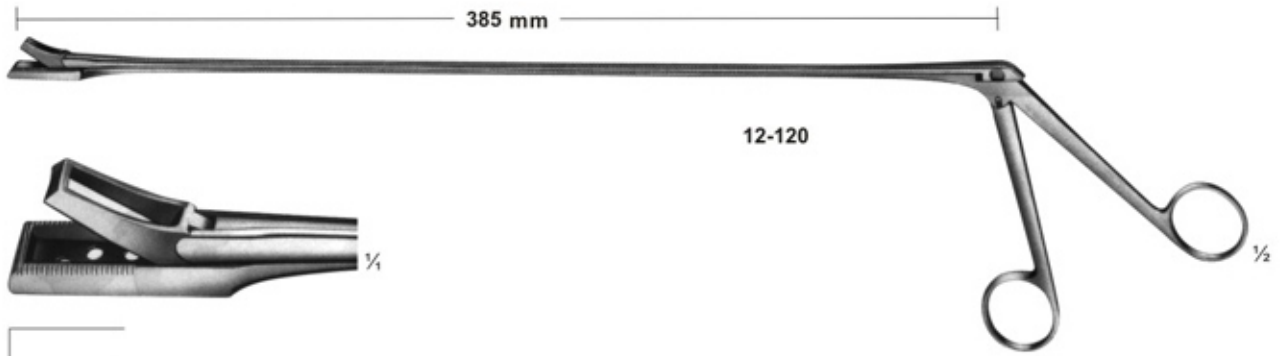

Biopsy Forceps

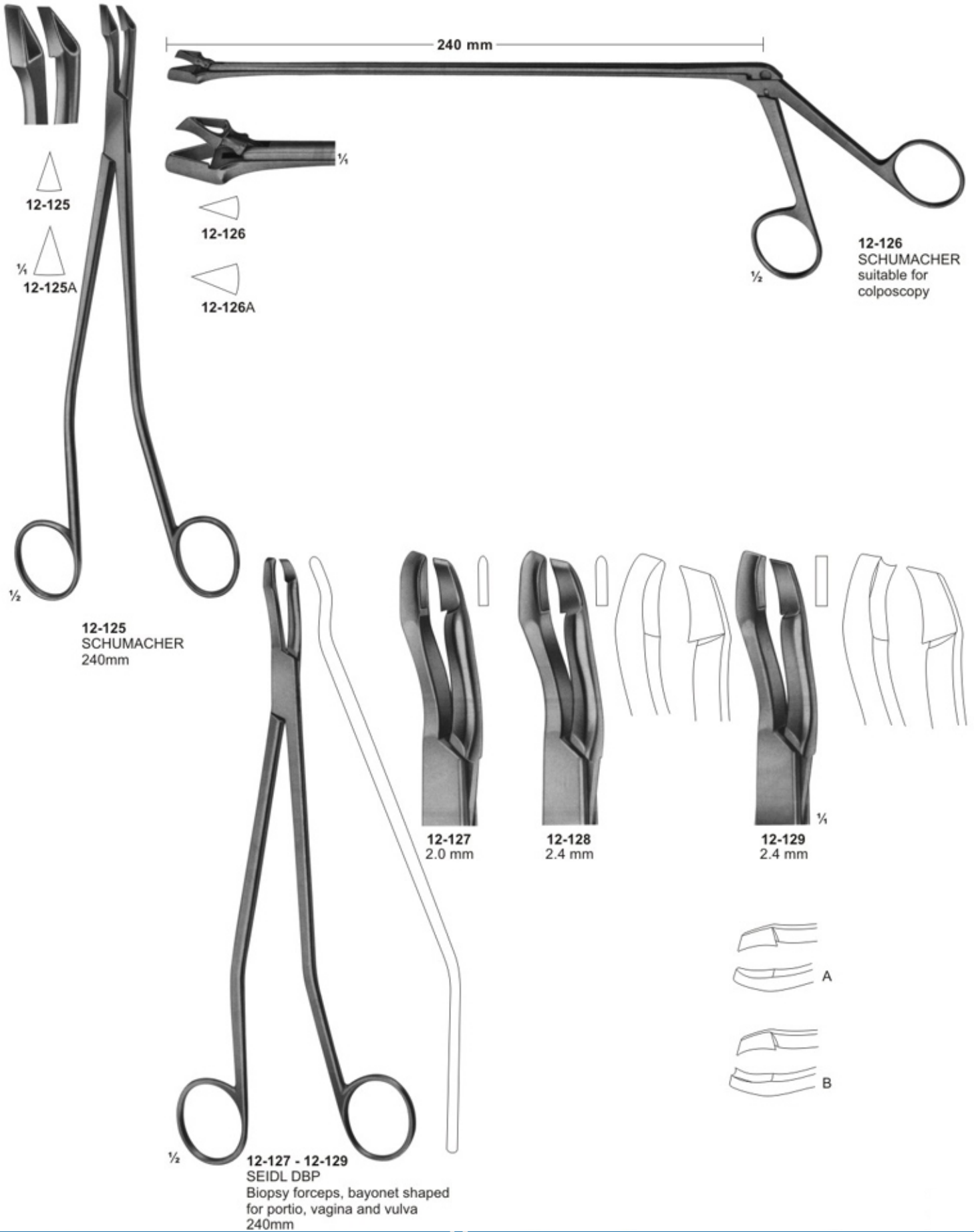

Biopsy Forceps

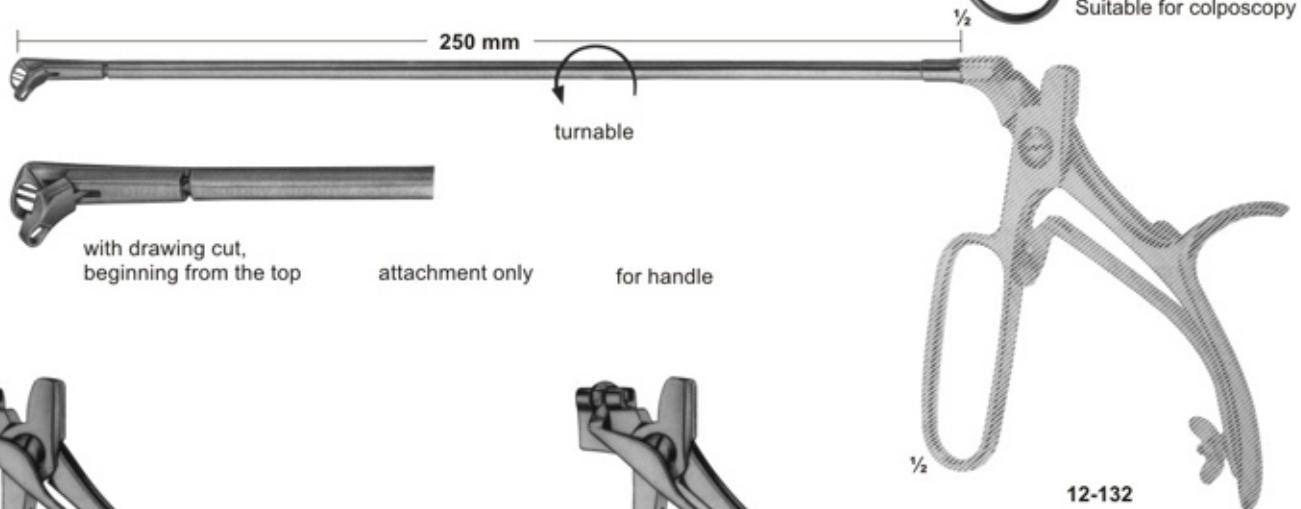
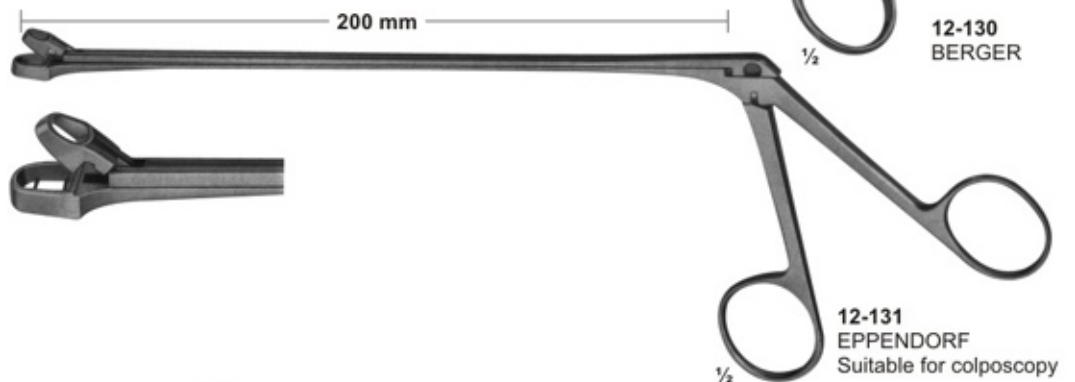
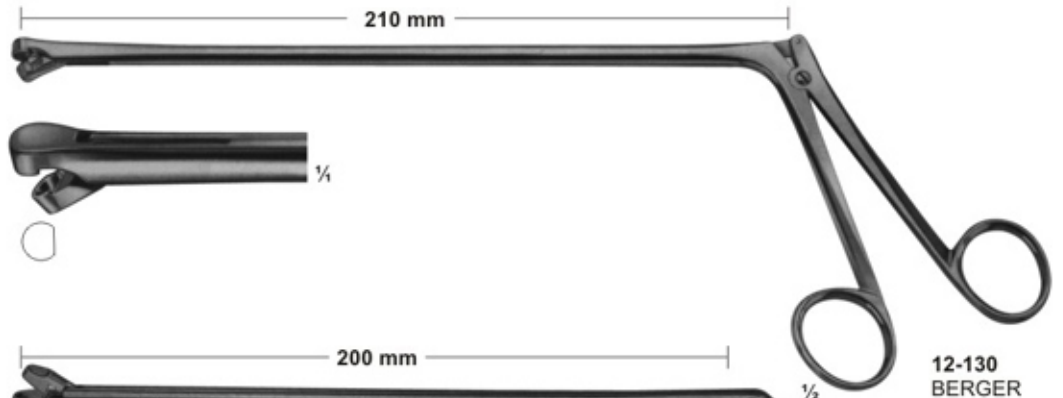

Uterine Scoops



1/2
12-140
SIMON
240 mm

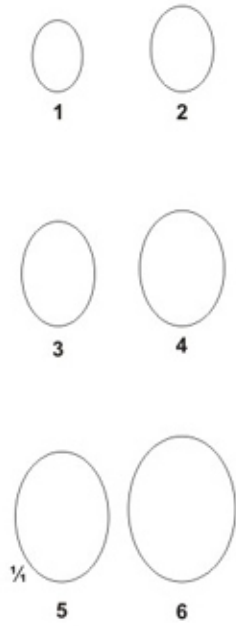

1/2
12-141
SCHROEDER
310 mm

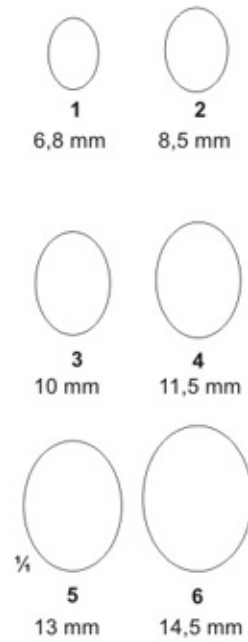

1/2
12-142
RECAMIER
300 mm

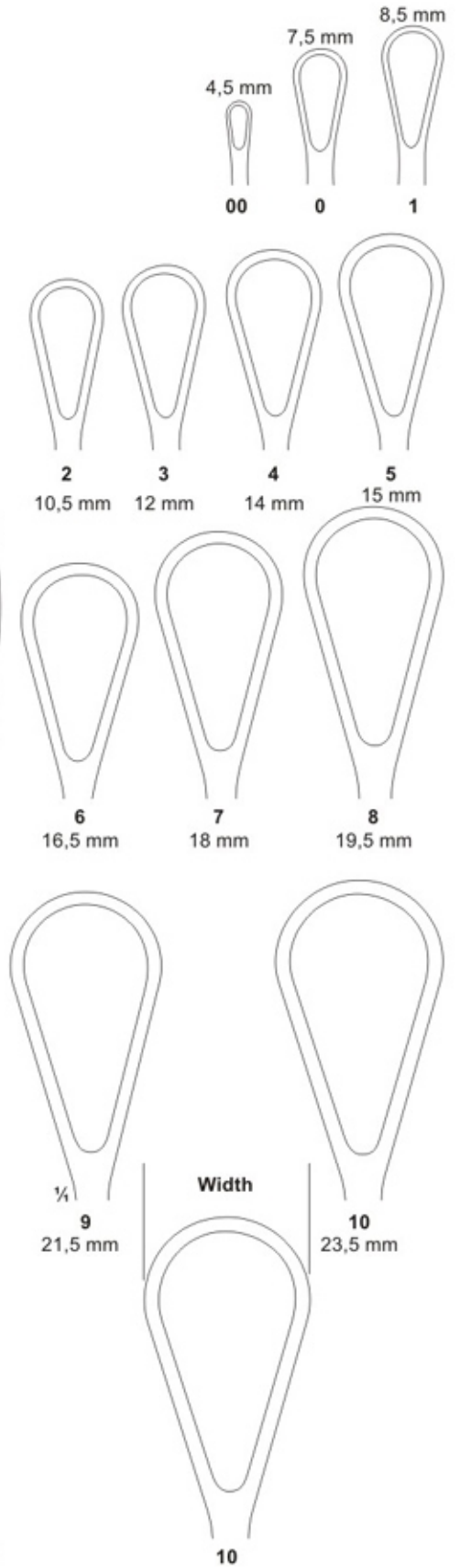

Obstetrical Forceps



13-101
NAEGELE
355 mm



13-102
NAEGELE
400 mm



13-103
SIMPSON-BRAUN
305mm

Obstetrics- Placenta and Ovum Forceps

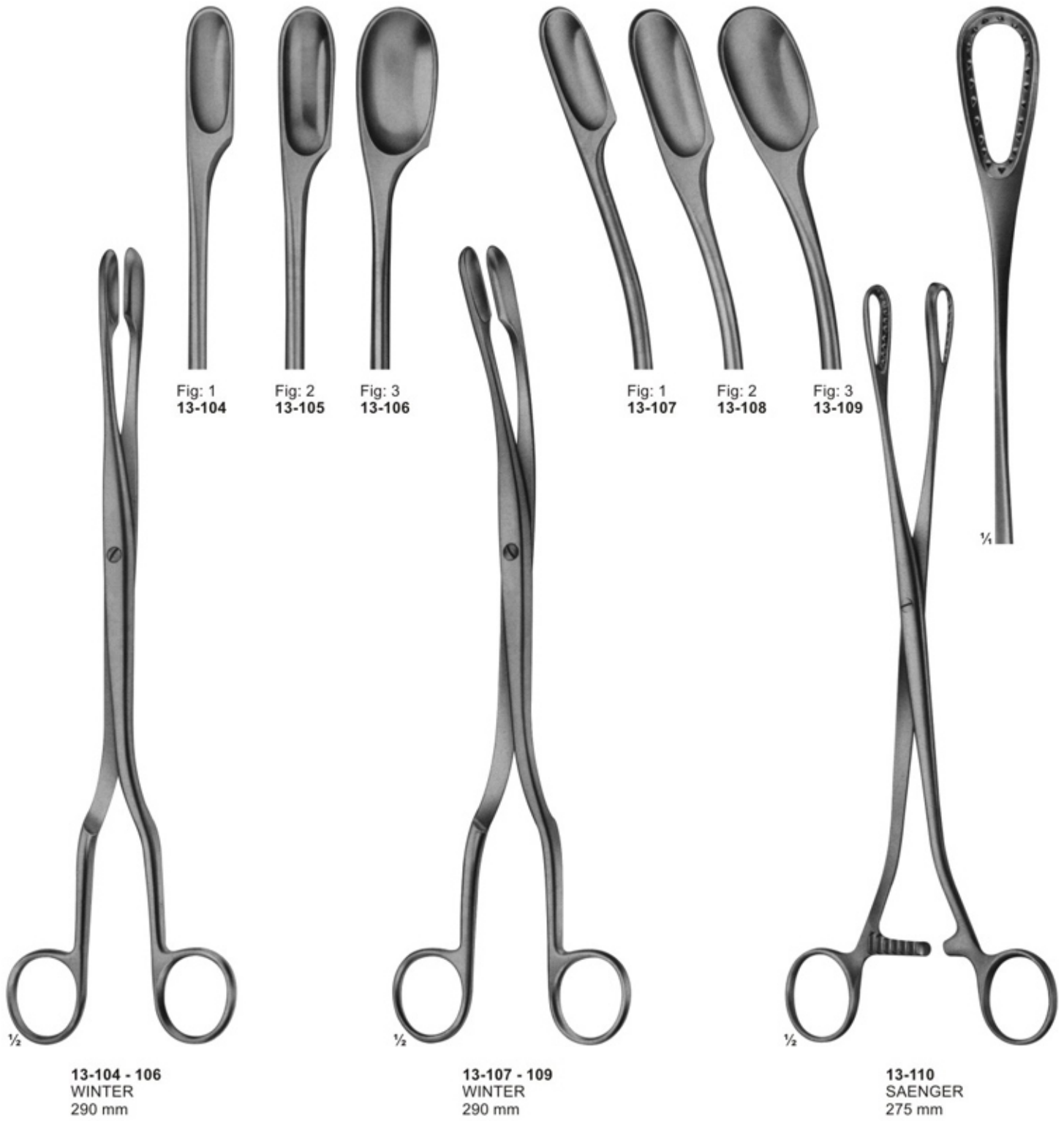

Tound-and Tracheal Hooks and Dilators

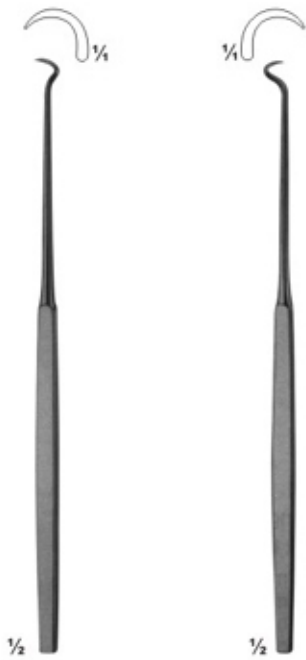

13-111
BOSE
165 mm



13-112
BOSE
165 mm



13-113 - 115
180 mm



13-113
sharp



13-114
blunt



13-115
stumpf/blunt



13-116
FINSEN
50 mm



13-117
FINSEN
70 mm



13-118
TROUSSEAU
120 mm



13-119
LABORDE
125 mm



13-120
LABORDE
strong pattern
135 mm



13-121
Cleaning Brush
for tracheal tubes
285 mm

Vascular Spatulas

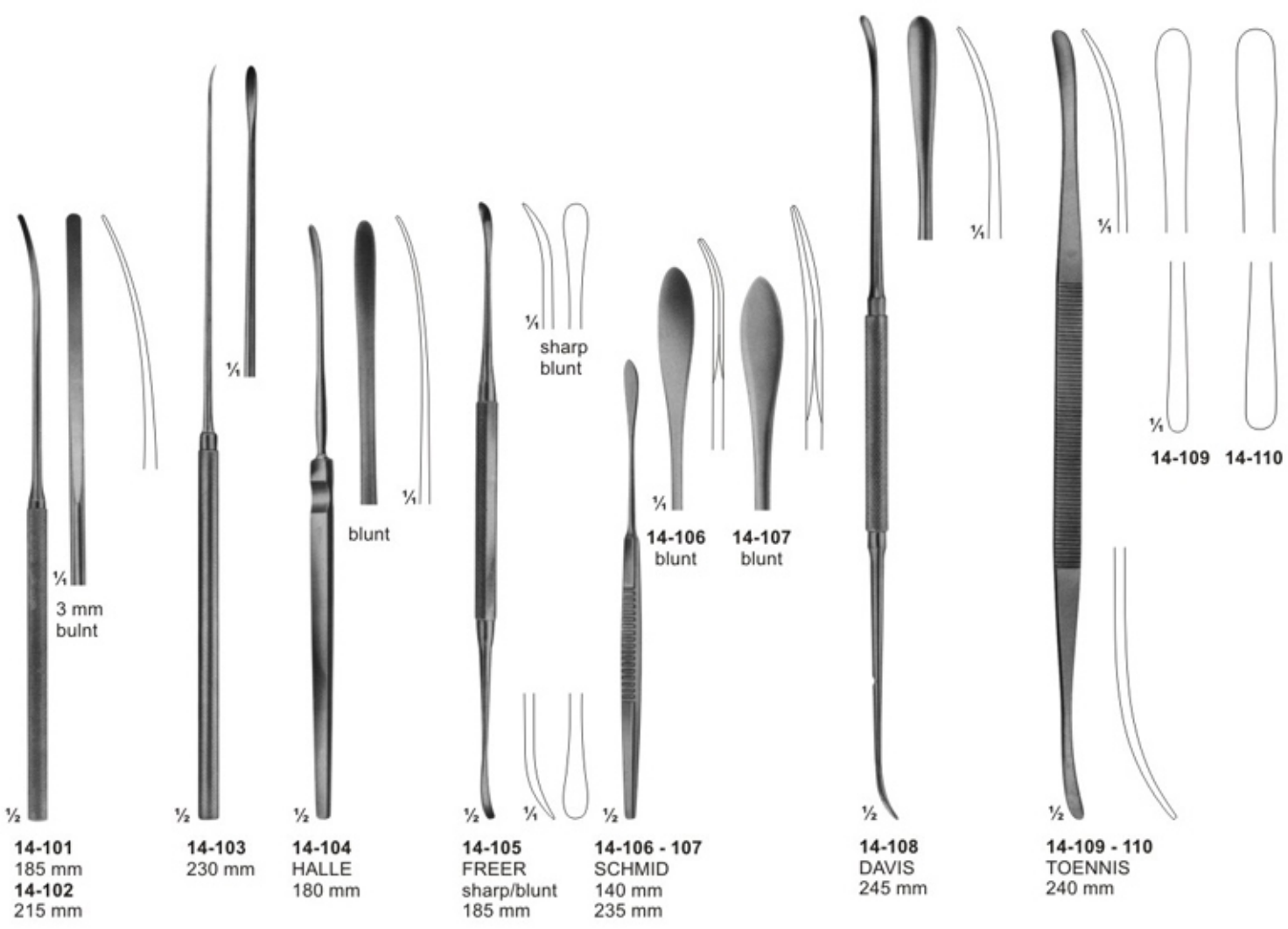

14-101
185 mm
14-102
215 mm

14-103
230 mm

14-104
HALLE
180 mm

14-105
FREER
sharp/blunt
185 mm

14-106 - 107
SCHMID
140 mm
235 mm

14-108
DAVIS
245 mm

14-109 - 110
TOENNIS
240 mm

ATRAUMATA Forceps

INSTRUMENTS Co.

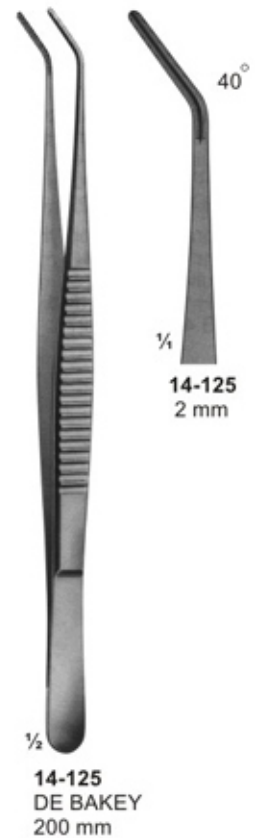
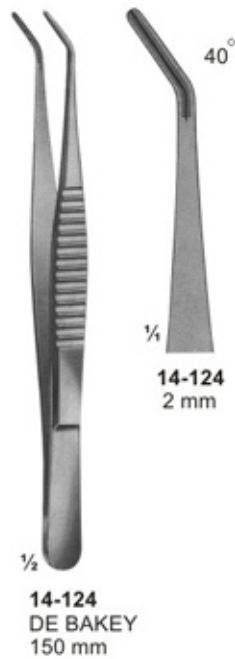
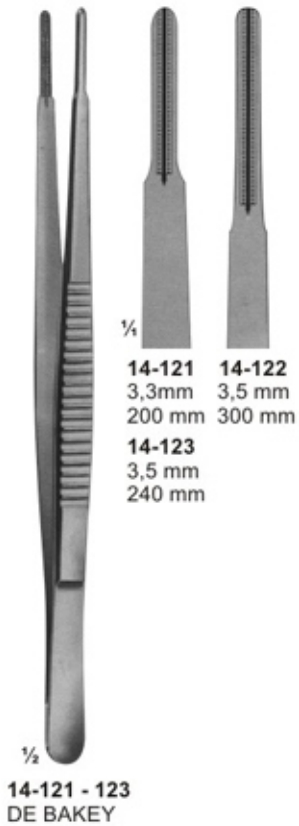
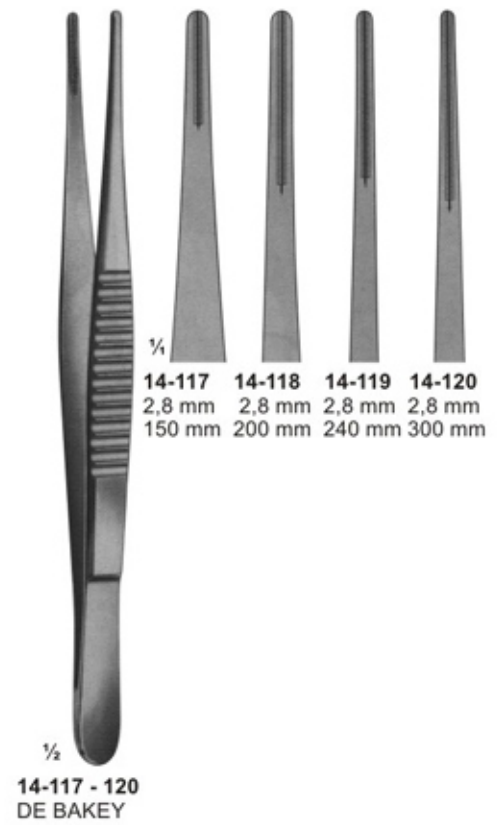
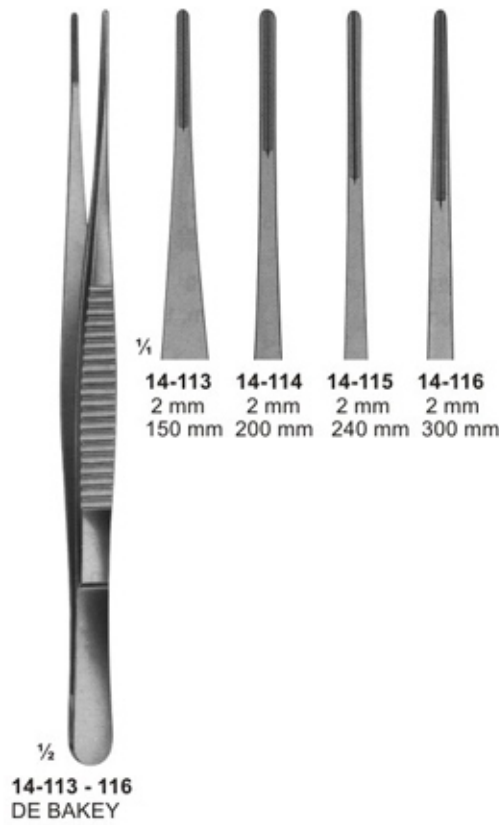
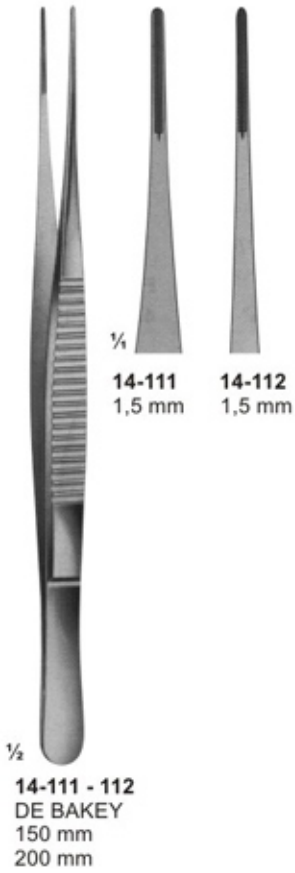

ATRAUMATA

Anastomosis- and Multi- Purpose- Clamps- Pediatric types

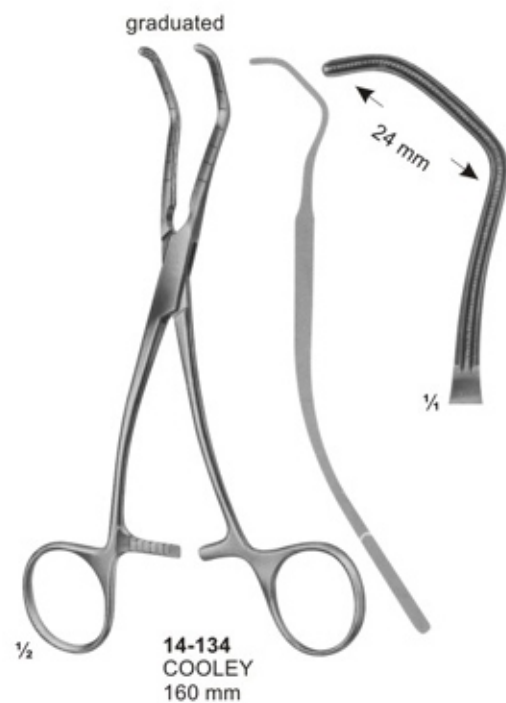
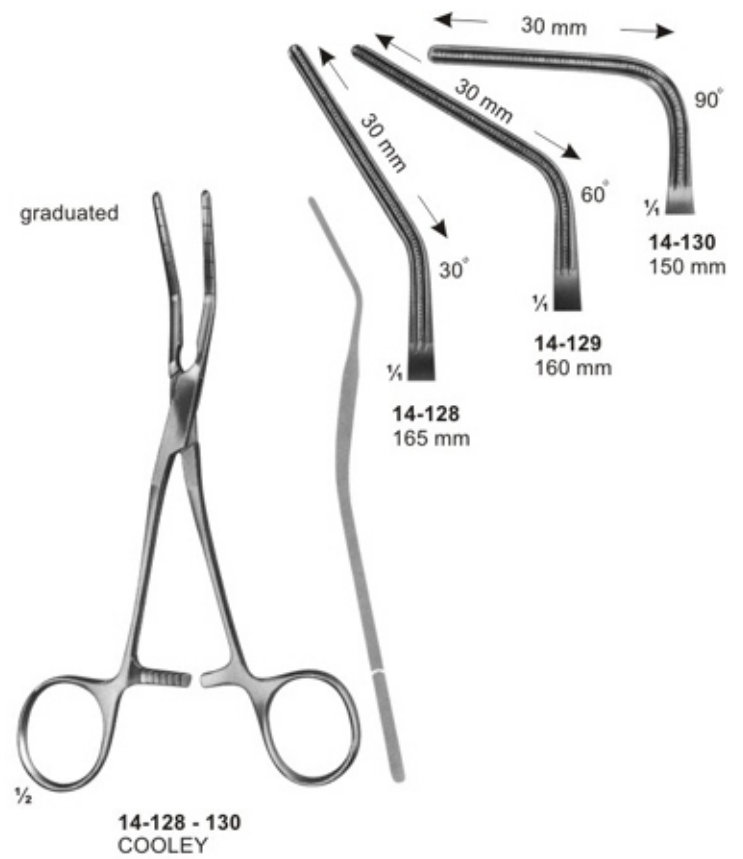
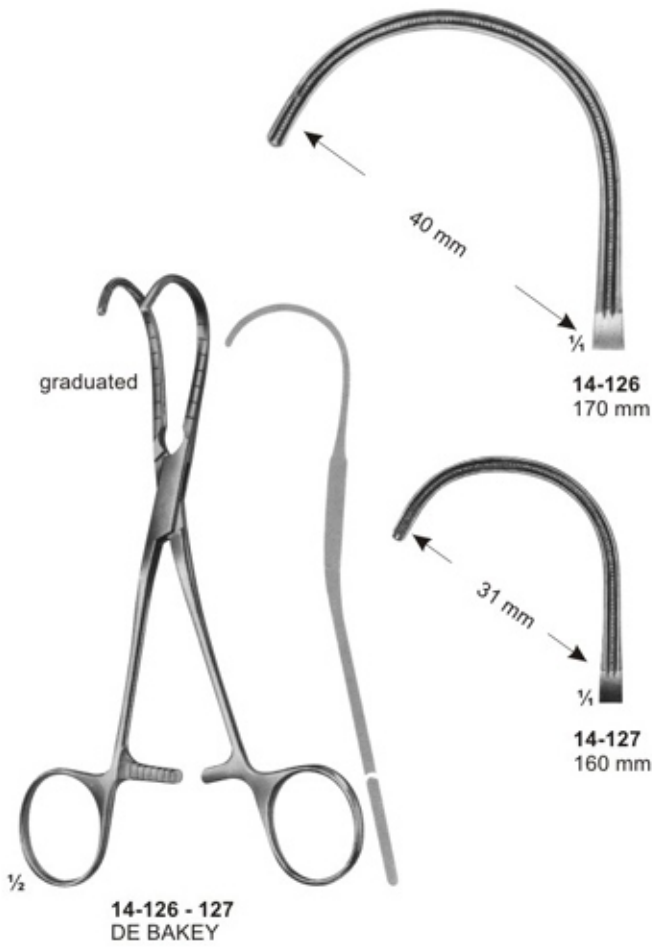

ATRAUMATA

Coarctation Clamps, Patent-Ductus & Peripheral-Vascular Clamps

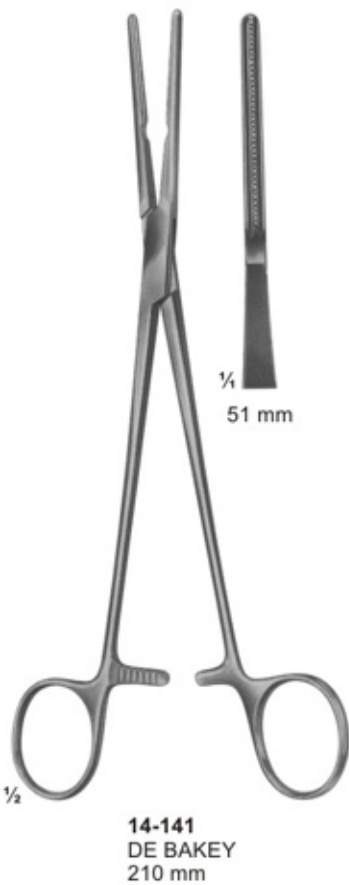
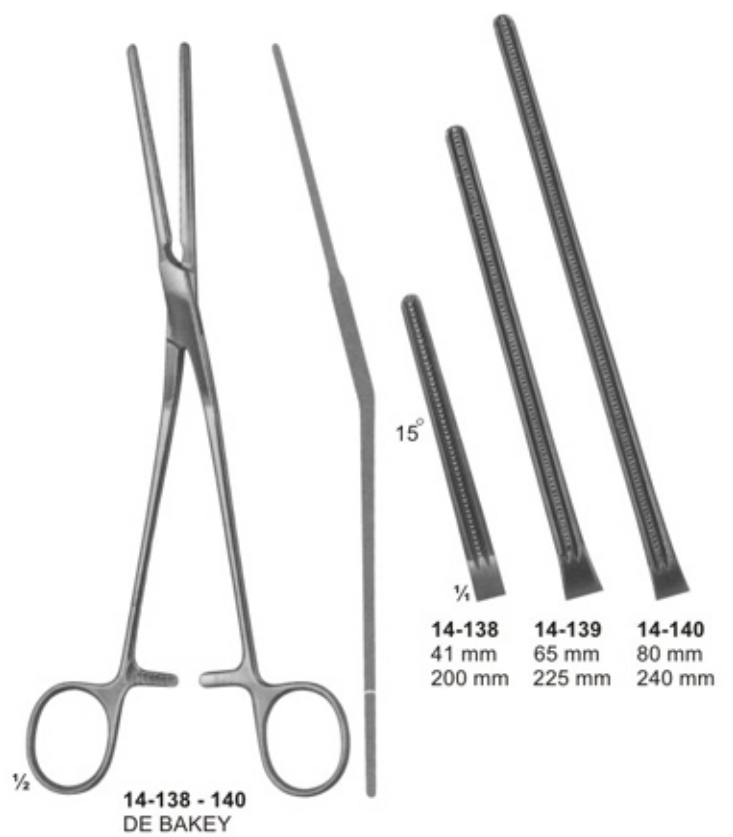

Aorta- Anastomosis Clamps

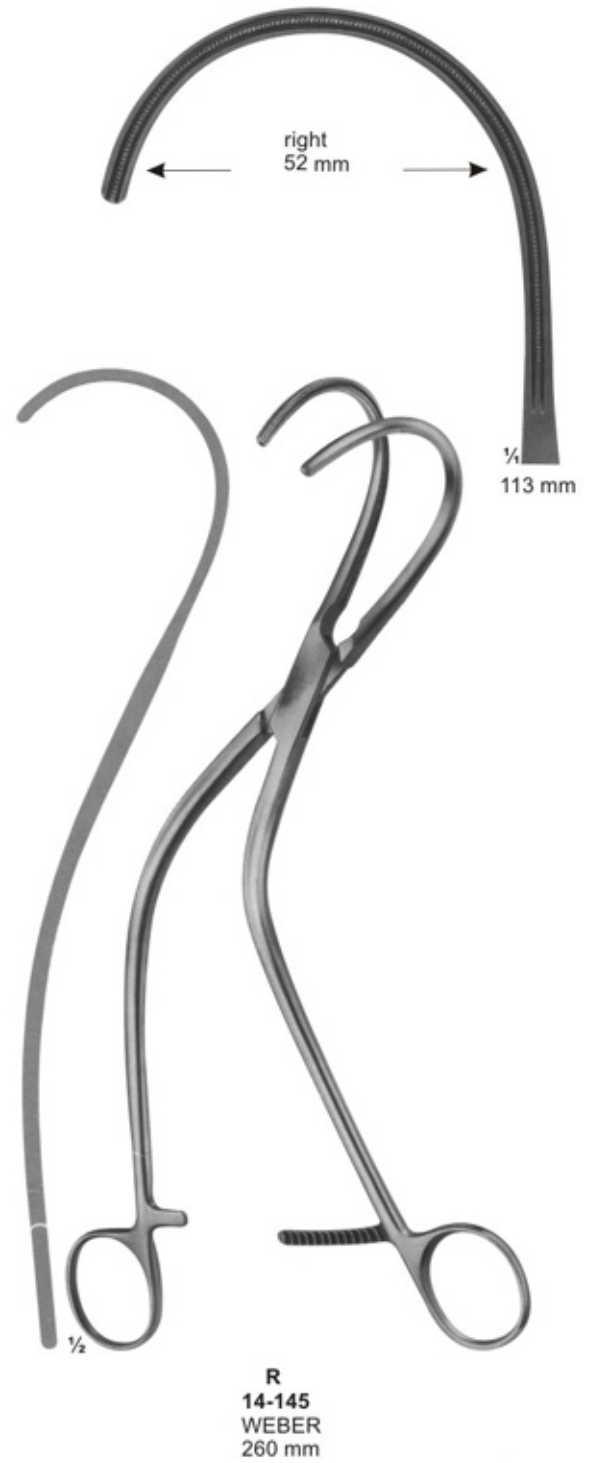
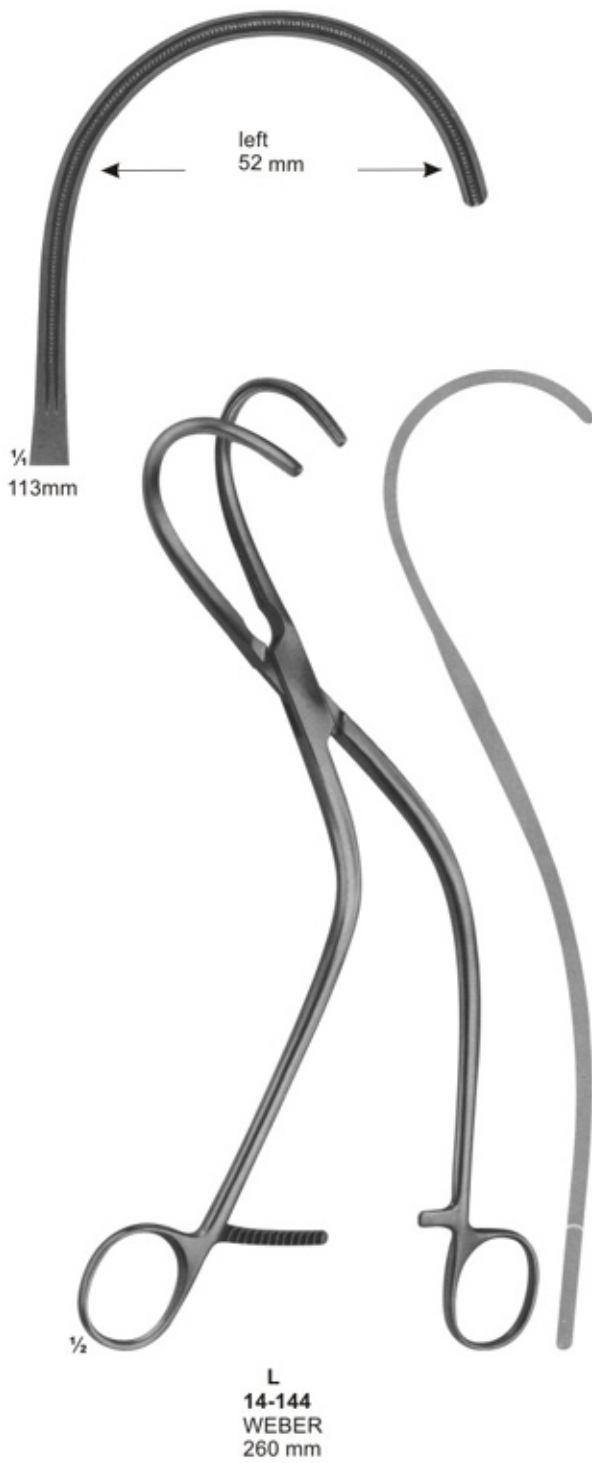

Multi- Purpose-Clamps



1/2 **14-146 - 149**
DE BAKEY

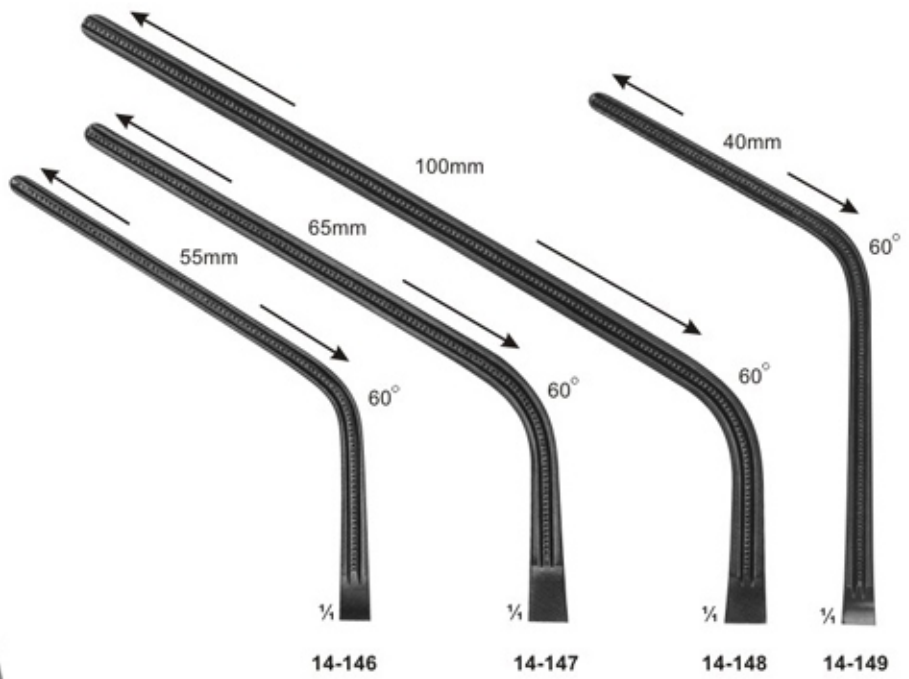

Total Length:	230 mm	280 mm	305 mm	240 mm
Length of jaws:	85 mm	100 mm	135 mm	93 mm



1/2 **14-150 - 153**
DE BAKEY

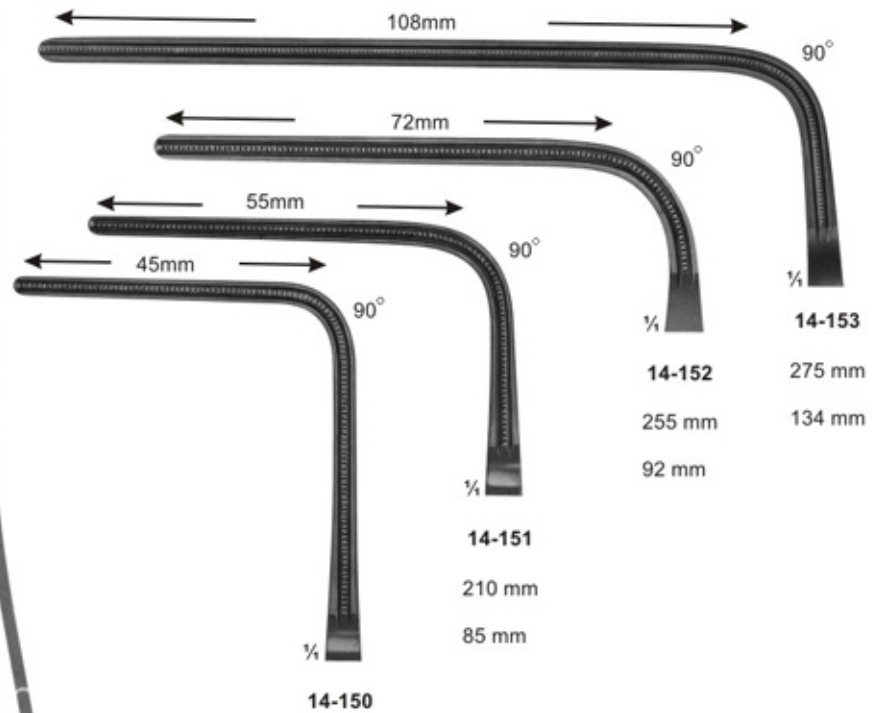

Total Length:	225 mm
Length of jaws:	93 mm

Sternum Instruments and Rib Shears



14-154
SCHUMACHER
Sternum shears
210 mm



14-155
LEBSCHÉ
Sternum chisel
200 mm



14-156
230 mm



14-157
COLLIN
195 mm



14-158
GLUCK
190 mm



14-159
BETHUNE
340 mm



14-160
BRUNNER
Universal pattern
340 mm



14-161
GIERTZ-STILLÉ
250 mm

Rib Spreaders

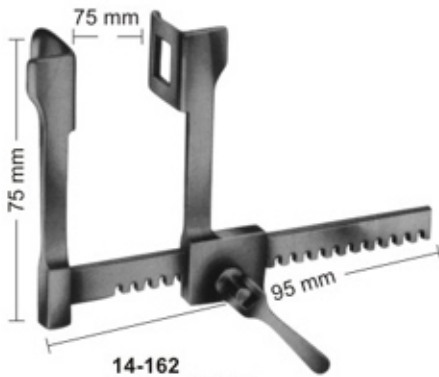

14-162
FINOCHIETTO
Blades
18X21 mm

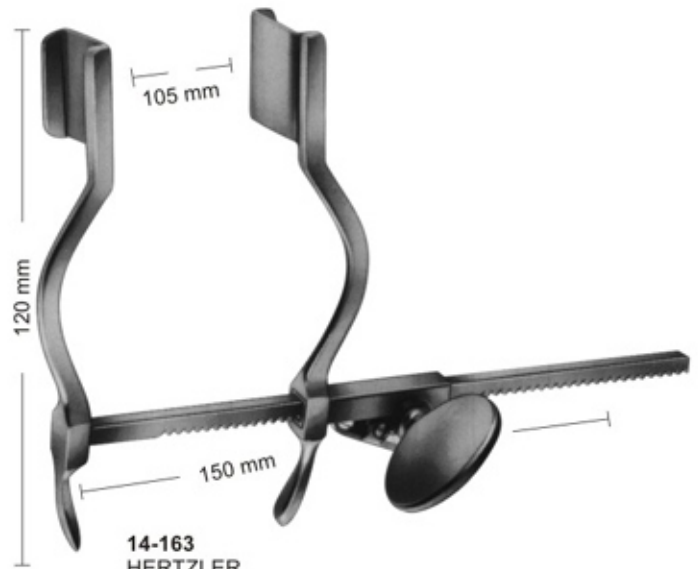

14-163
HERTZLER
Blades
20X25 mm

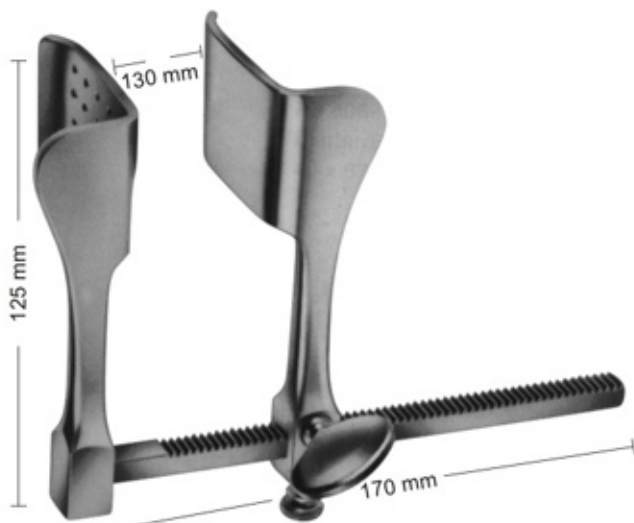

14-164
TUFFIER
Blades
43X53 mm

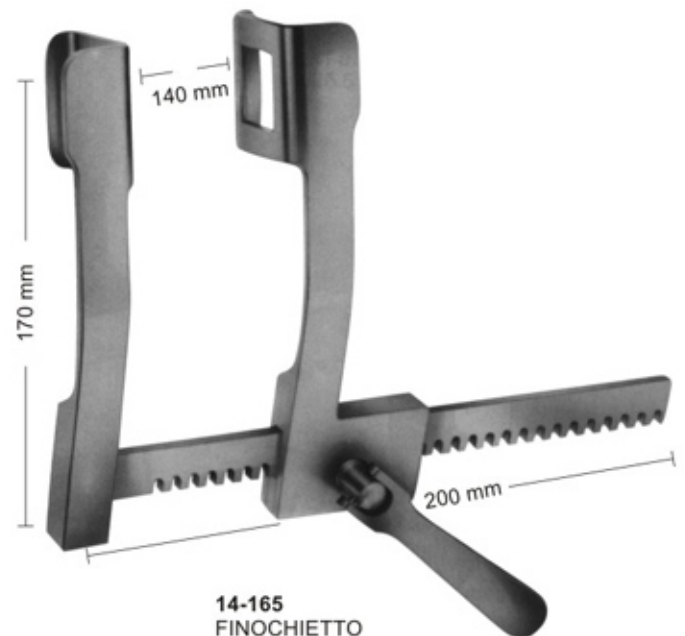

14-165
FINOCHIETTO
Blades
36X45 mm

Rib Spreaders-and Contractors



14-166
SELLORS
 Rib spreader-and contractor
 with swivel blades
 200 mm



14-167
BAILEY
 150 mm



14-168
 for children

14-169
 for adults

14-168 - 169
BAILEY
 200 mm

Punches

130° upwards cutting

15-101
1 mm 

KERRISON - JACOBY

FERRIS-SMITH-KERRISON

15-102
2 mm 

15-103
3 mm 

15-104
4 mm 

15-105
5 mm 

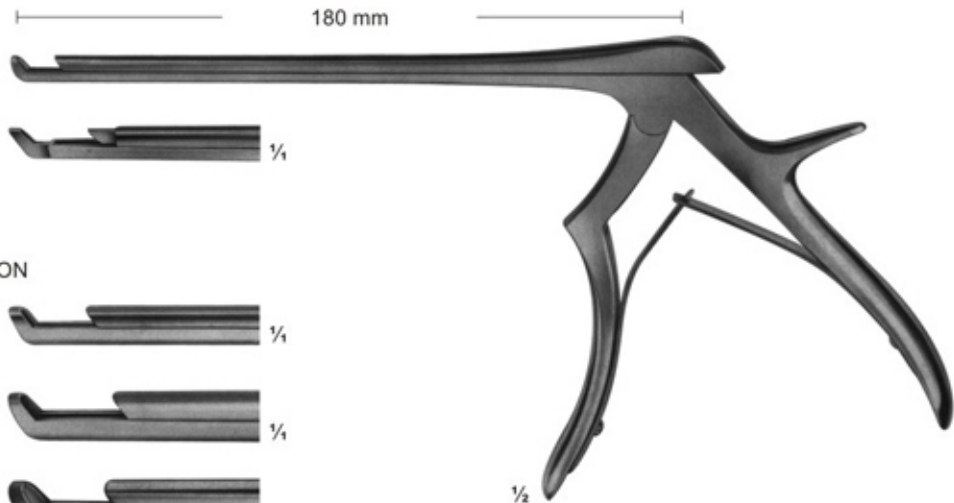

15-101 - 105

90° upwards cutting

KERRISON - JACOBY

15-106
1 mm 

15-107
2 mm 

FERRIS-SMITH-KERRISON

15-108
3 mm 

15-109
4 mm 

15-110
5 mm 

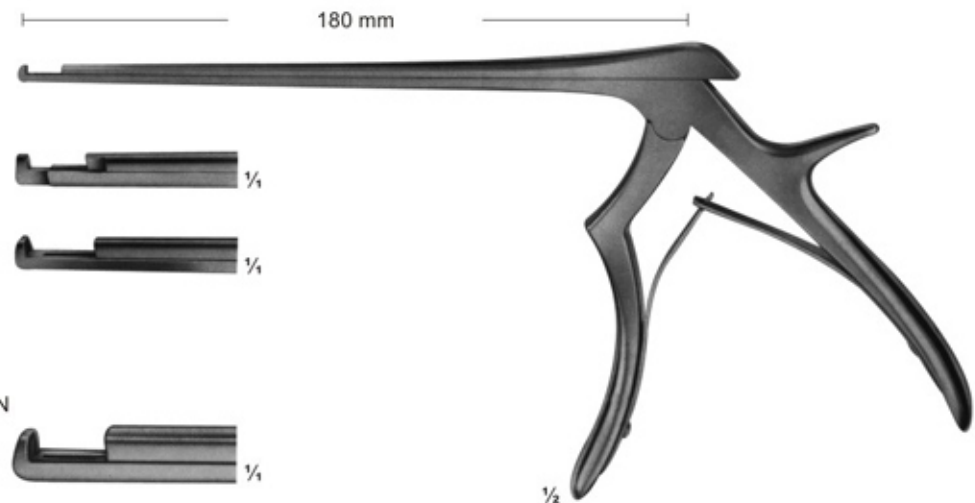

15-106 - 110

Punches

90° upwards cutting

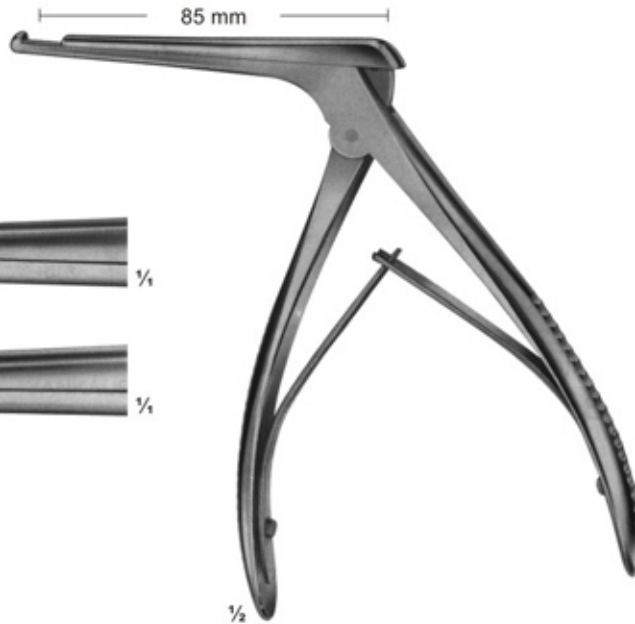

15-111
4 mm



1/4

15-112
5 mm



1/4

15-111 - 15-112
KERRISON

90° upwards cutting

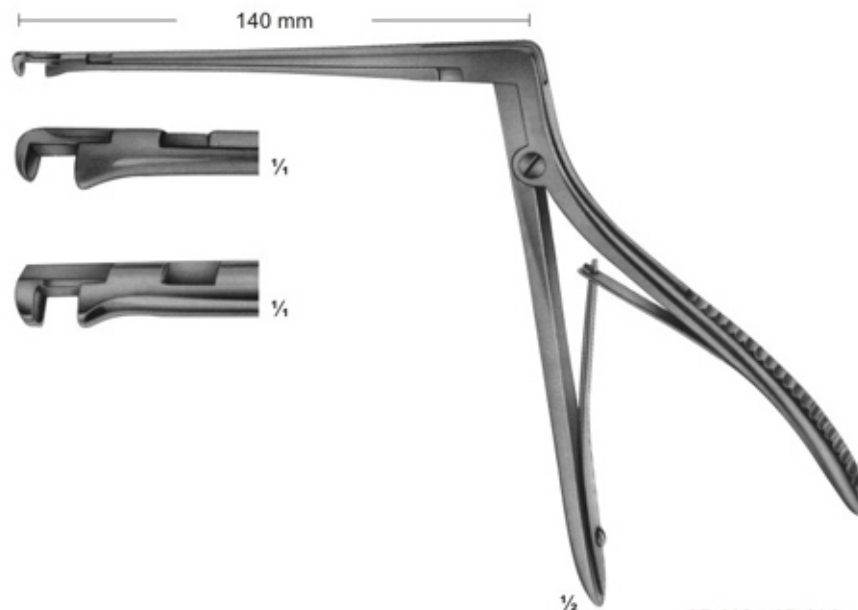

15-113
3,3 mm



1/4

15-114
4,0 mm



1/4

15-113 - 15-114
HAJEK-KOFLER

Rongeurs

INSTRUMENTS Co.

LOVE-GRUENWALD

15-115
2 X 10 mm

15-116
3 X 10 mm

SPURLING
15-117
4 X 10 mm



15-115 - 15-117

15-118
2 mm

15-119
3 mm

15-120
4 mm

15-121
5 mm

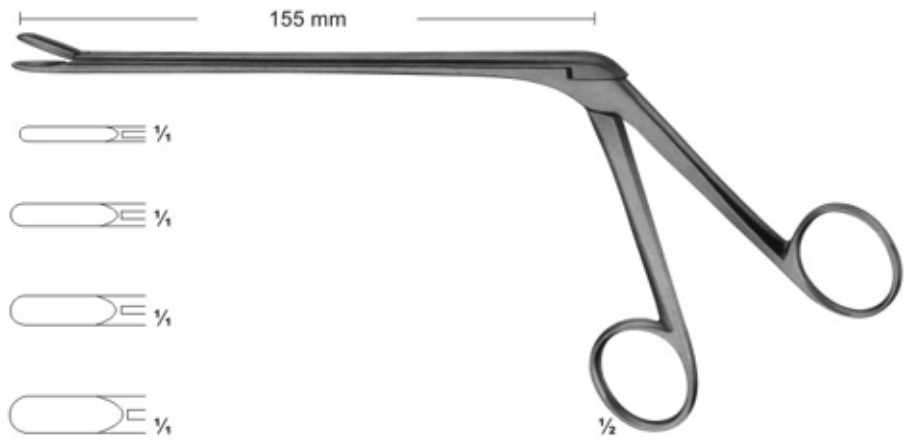

15-118 - 15-121
CASPAR

150°

15-122
2 mm

15-123
3 mm

15-124
4 mm

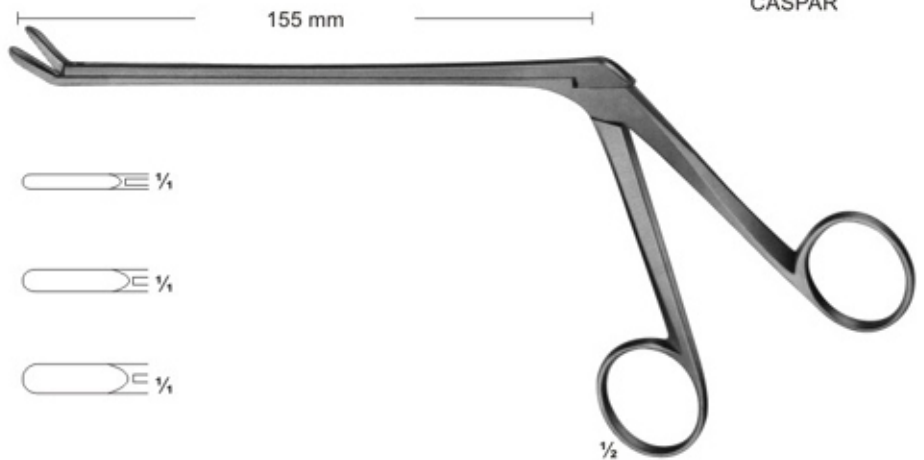

15-122 - 15-124
CASPAR

Rongeurs

Angled positions for rongeurs

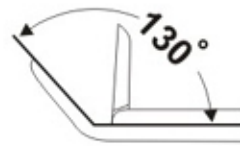
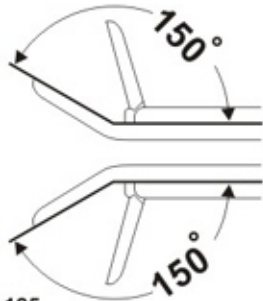

15-125
3,0 mm

15-126
3,6 mm

15-127
4,2 mm

15-128
4,8 mm

15-129
5,8 mm

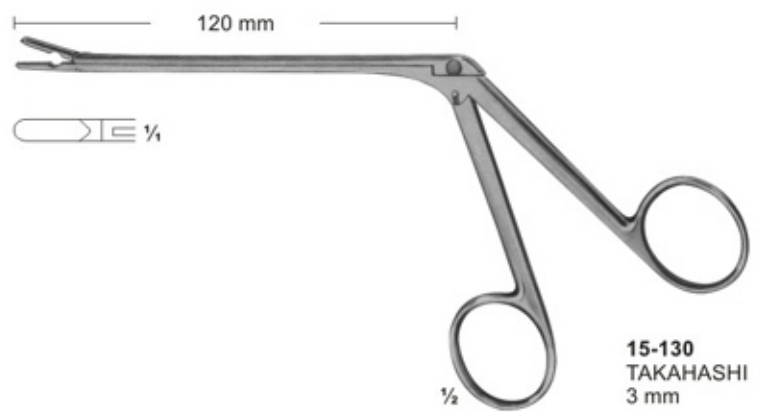
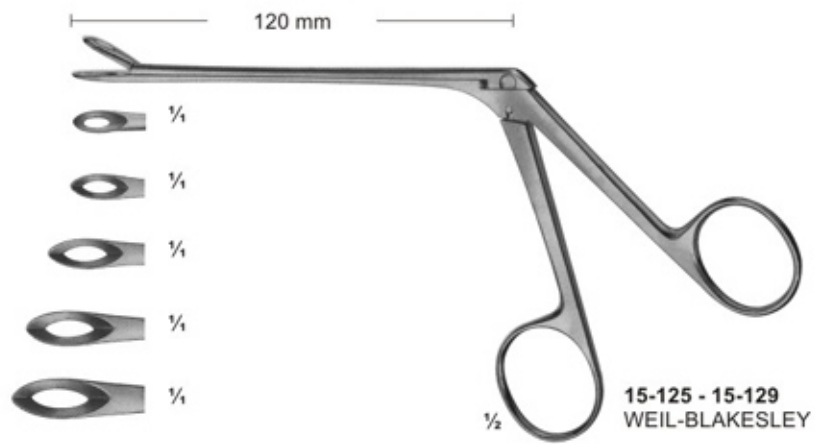

130°

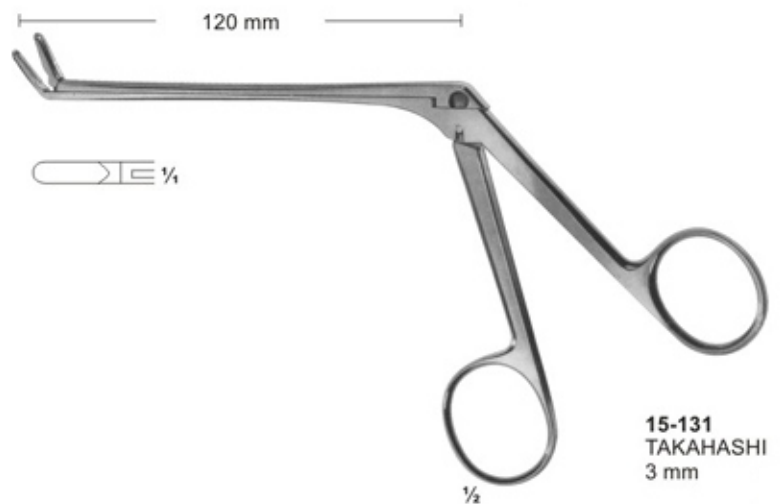

Rongeurs

150°

Lower part of jaws movable

15-132
2 mm

15-133
3 mm

15-134
4 mm

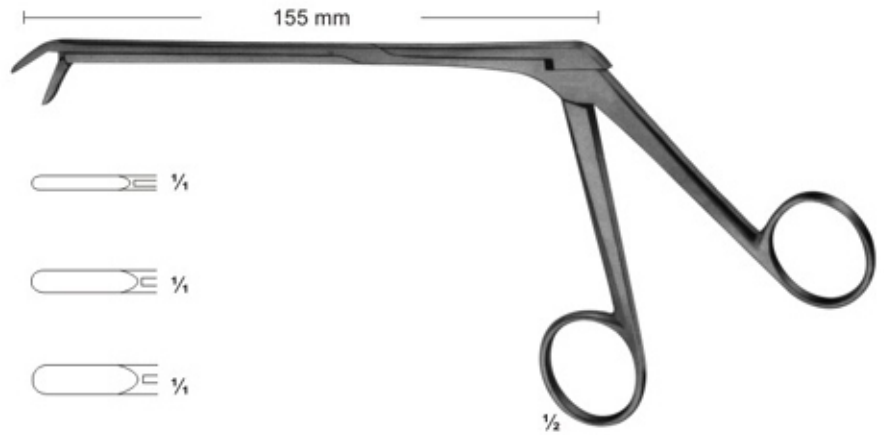

15-132 - 15-134
CASPAR

Length of shaft 140 mm	Length of shaft 160 mm	Length of shaft 185 mm	size of jaws
15-135	15-140	15-145	2 X 12 mm
15-136	15-141	15-146	3 X 12 mm
15-137	15-142	15-147	4 X 14 mm
15-138	15-143	15-148	5 X 14 mm
15-139	15-144	15-149	6 X 16 mm

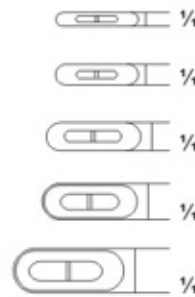

15-135 - 15-149
CASPAR

150°

Length of shaft 140 mm	Length of shaft 160 mm	Length of shaft 185 mm	size of jaws
15-150	15-153	15-156	3 X 12 mm
15-151	15-154	15-157	4 X 14 mm
15-152	15-155	15-158	5 X 14 mm



15-150 - 15-158
CASPAR

Rongeurs

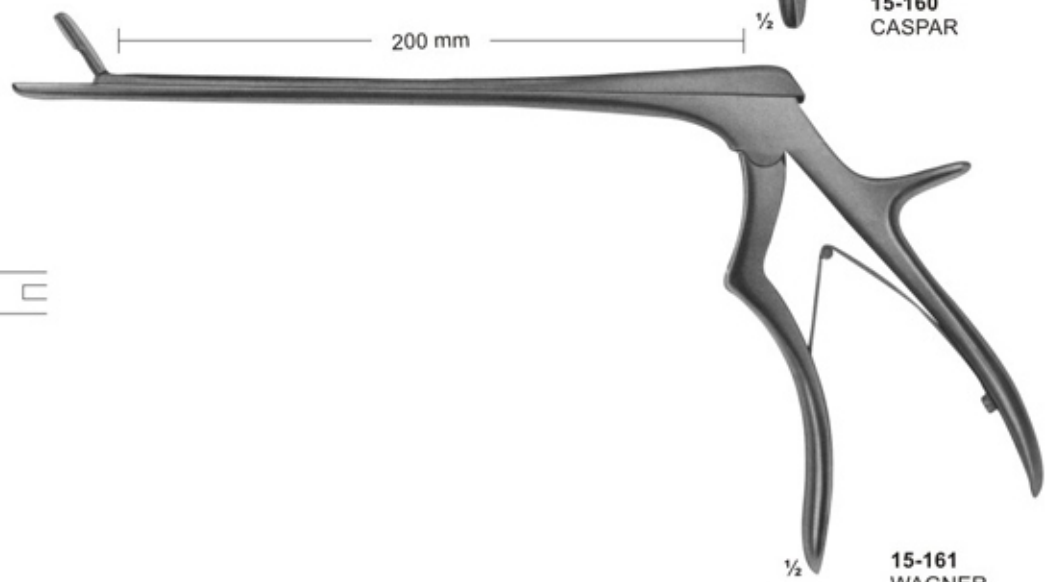
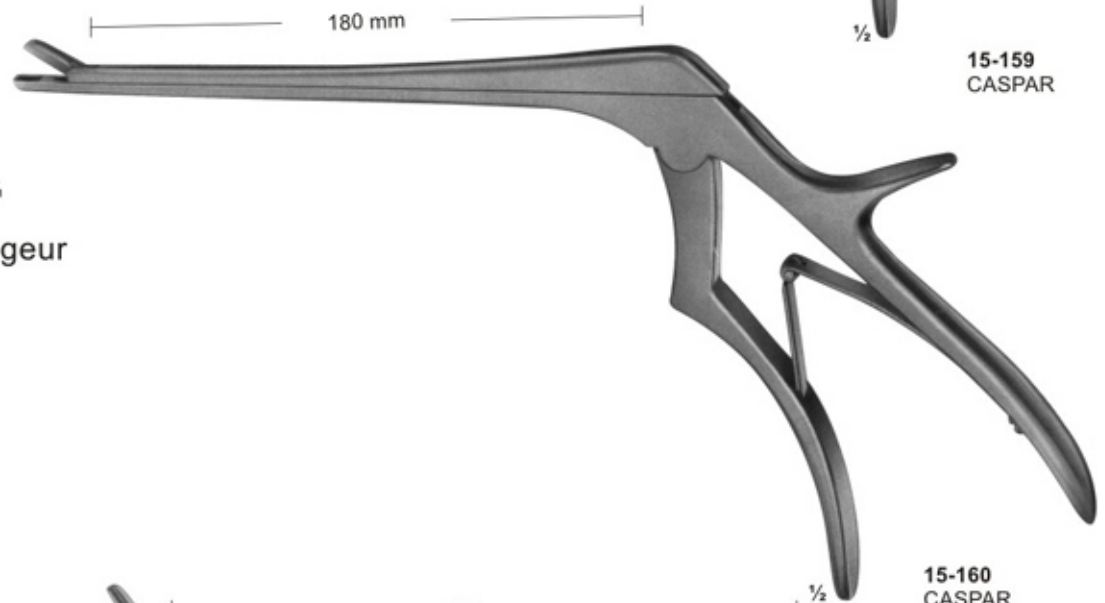
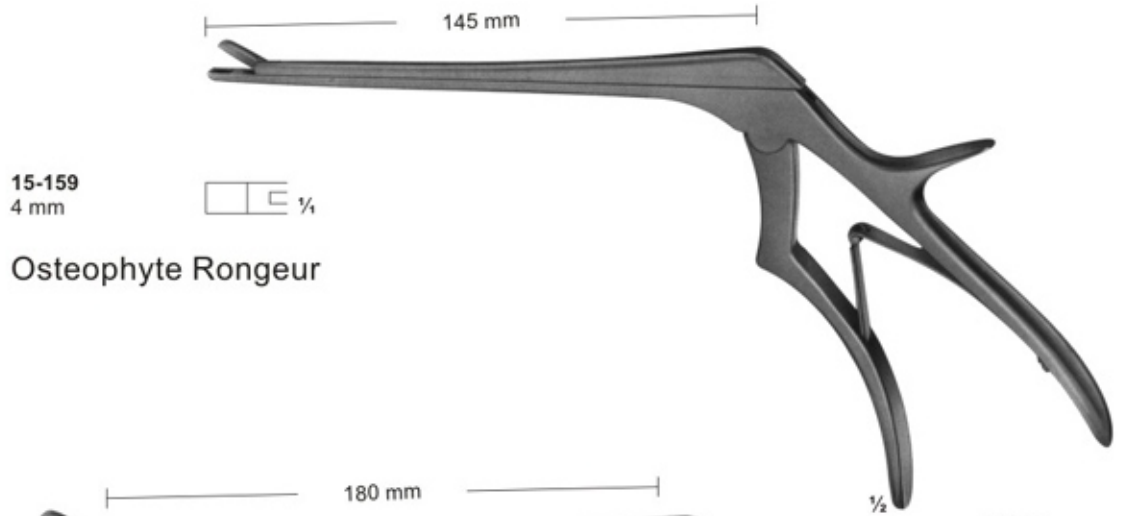

Elevators and Bone Levers

INSTRUMENTS Co.

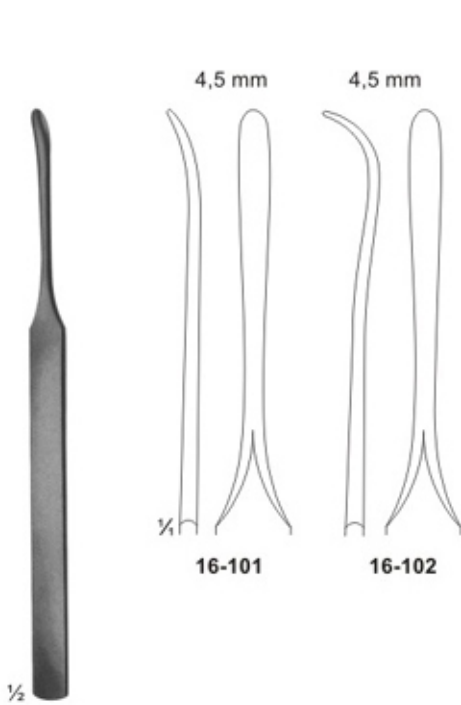

16-101 - 102
KONIG
155 mm



16-103
WILLIGER
165 mm

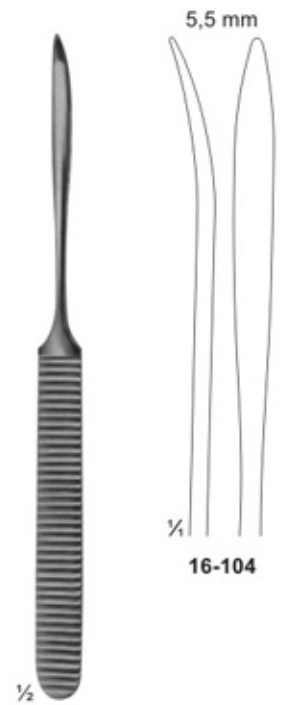

16-104
WILLIGER
170 mm

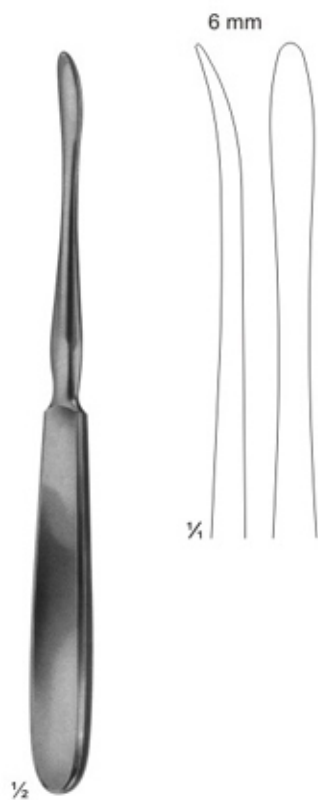

16-105
QUERVAIN
195 mm

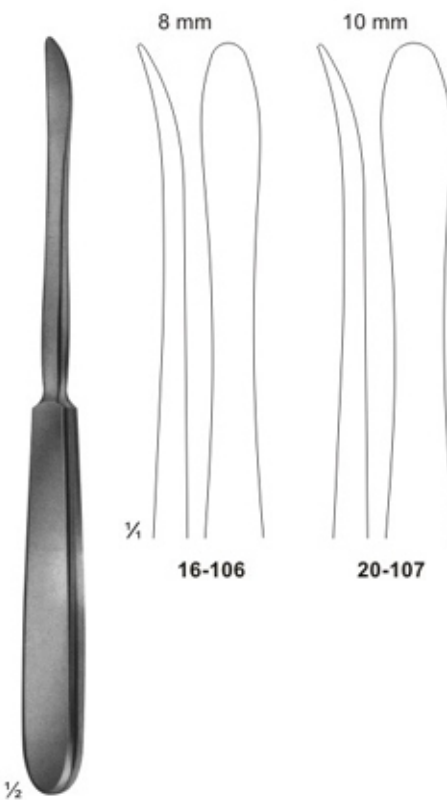

16-106 - 107
LANGENBACK
195 mm

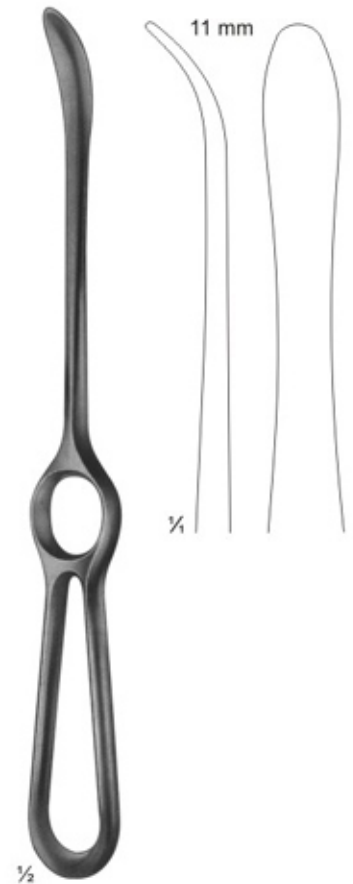

16-108
LANGENBACK
230 mm

Bone Levers



Raspatories



16-114
PARTSCH
150 mm

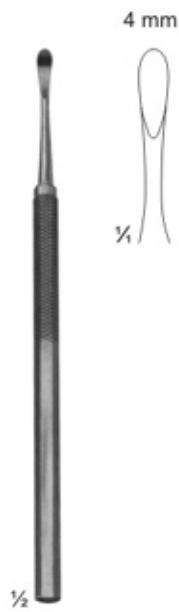

16-116
PARTSCH mod. LANGE
145 mm



16-117
MC KENTY
155 mm

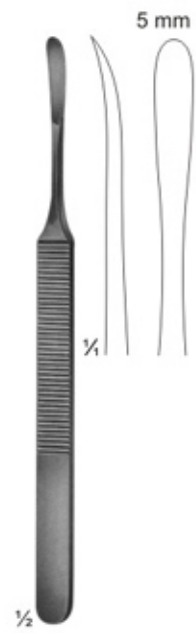

16-118
KOENIG
155 mm

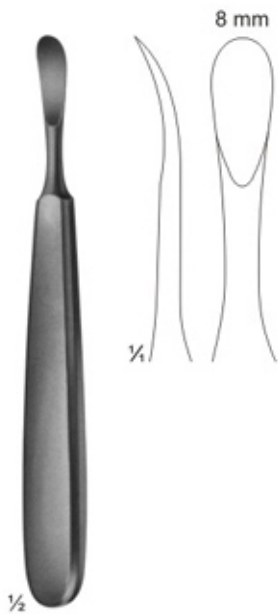

16-119
TRELAT
150 mm

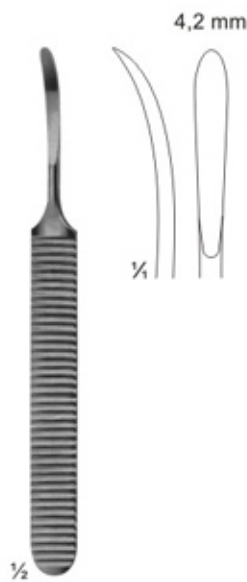

16-120
WILLIGER
140 mm



16-121
WILLIGER
160 mm

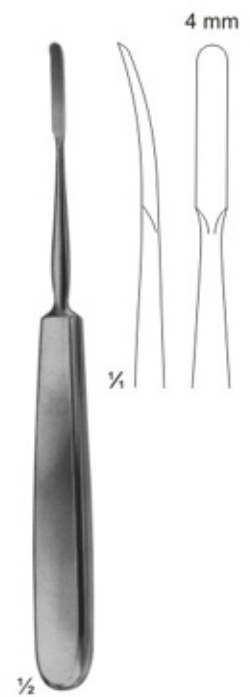

16-122
JOSEPH
170 mm

Bone File and Rasps

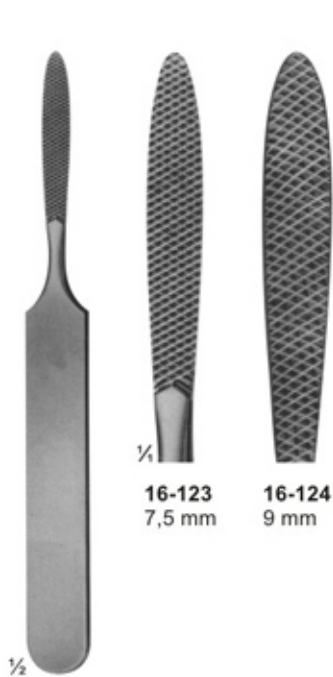

16-123
7,5 mm

16-124
9 mm

16-123
JOSEPH
fine, chequered

16-124
coarse, chequered
165 mm

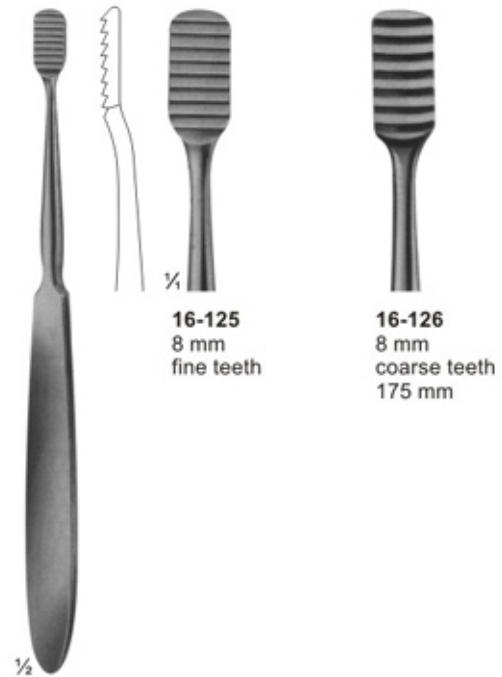

16-125
8 mm
fine teeth

16-126
8 mm
coarse teeth
175 mm

16-125 - 16-126
LEWIS



16-127
9 mm

16-127
MALTZ
down stroke
180 mm

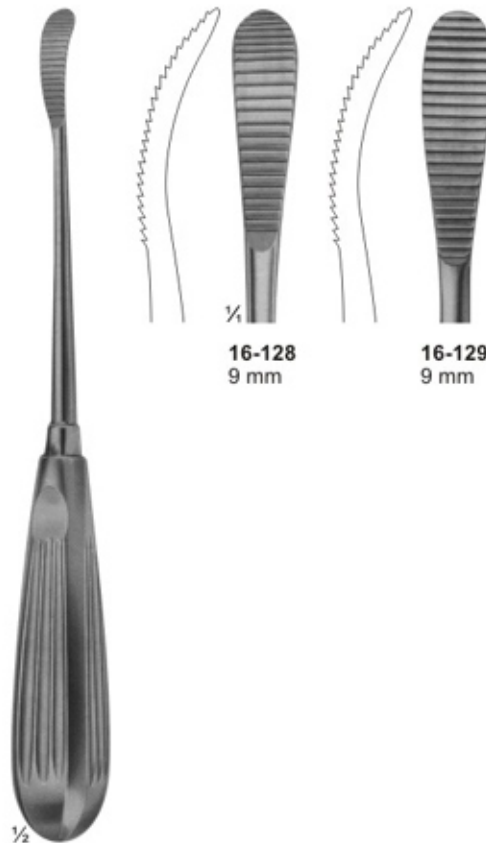

16-128
9 mm

16-129
9 mm

16-128 - 16-129
AUFRICHT
up stroke
16-129
down stroke
220 mm



16-130
6,5 mm

16-130
GALLAHER
190 mm

Bone Currettes



16-131
JACOBSON
140 mm



16-132
MARTINI
140 mm



16-133
MARTINI
140 mm



16-134
WILLIGER
145 mm



16-135
JANSEN
160 mm



16-136
BARTH
180 mm

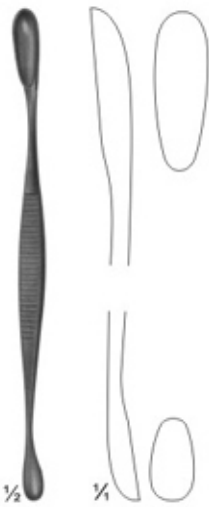

16-137
VOLKMANN
130 mm

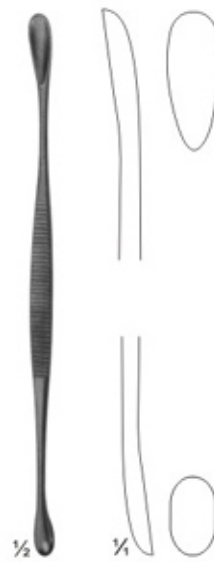

16-138
VOLKMANN
145 mm

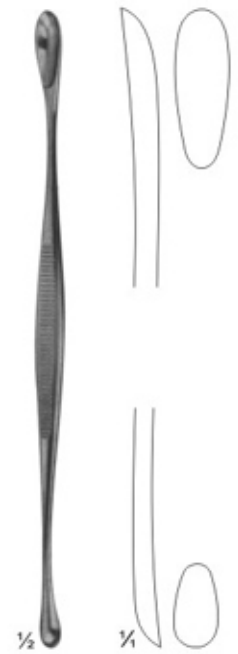

16-139
VOLKMANN
170 mm

Mallets Weights refer to the heads of the mallets
Hammer Die Gewichtsangaben beziehen sich auf den Kopf des jeweiligen Hammers



17-101
MEAD
 185 g
 with interchangeable
 plastic disks
 190 mm
17-102
 pair of spare disks



17-103
 140 g
 with interchangeable
 plastic disks
 185 mm
17-104
 pair of spare disks



17-105
COTTLE
 140 g
 1 Side Flat
 1 Side convex
 185 mm



17-106
 165 g
 lead filled head
 190 mm

Osteotomes, Chisels and Gouges

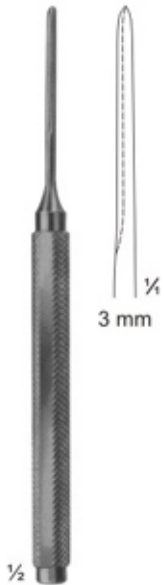

17-107
MANNERFELT
Gouge
155 mm

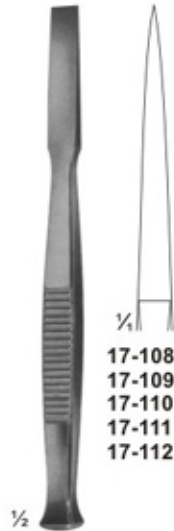

17-108 - 112
Osteotomes
140 mm

- 17-108** 4 mm
- 17-109** 6 mm
- 17-110** 8 mm
- 17-111** 10 mm
- 17-112** 12 mm

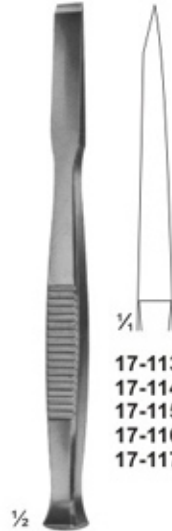

17-113 - 117
Chisels
140 mm

- 17-113** 4 mm
- 17-114** 6 mm
- 17-115** 8 mm
- 17-116** 10 mm
- 17-117** 12 mm



17-118 - 122
Gouges
140 mm

- 17-118** 4 mm
- 17-119** 6 mm
- 17-120** 8 mm
- 17-121** 10 mm
- 17-122** 12 mm

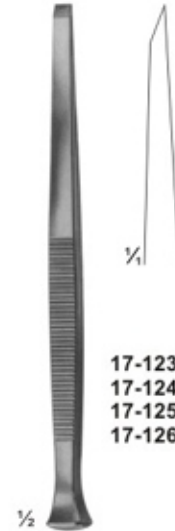

17-123 - 126
Chisels
140 mm

- 17-123** 3 mm
- 17-124** 4 mm
- 17-125** 5 mm
- 17-126** 6 mm

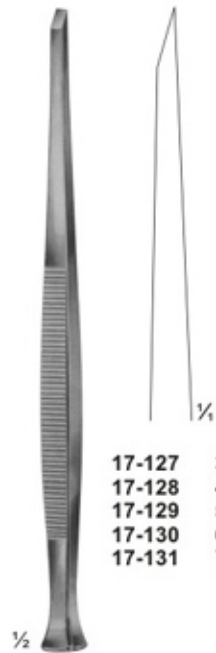

17-127 - 131
Chisels
170 mm

- 17-127** 3 mm
- 17-128** 4 mm
- 17-129** 5 mm
- 17-130** 6 mm
- 17-131** 7 mm



17-132 - 135
Gouges
140 mm

- 17-132** 3 mm
- 17-133** 4 mm
- 17-134** 5 mm
- 17-135** 6 mm

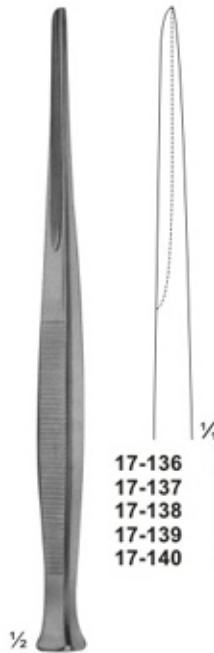

17-136 - 140
Gouges
170 mm

- 17-136** 3 mm
- 17-137** 4 mm
- 17-138** 5 mm
- 17-139** 6 mm
- 17-140** 7 mm



17-141 - 142
Chisels
160 mm

- 17-141** 4 mm
- 17-142** 6 mm



17-143 - 144
Gouges
160 mm

- 17-143** 3 mm
- 17-144** 5 mm

Reposition Forceps, Bone Holding Forceps



17-145
Patella forceps
185 mm



17-146
Forceps with
ratchet fixation
140 mm



17-147
Forceps with
thread fixation
170 mm



17-148
Forceps with
thread fixation
235 mm

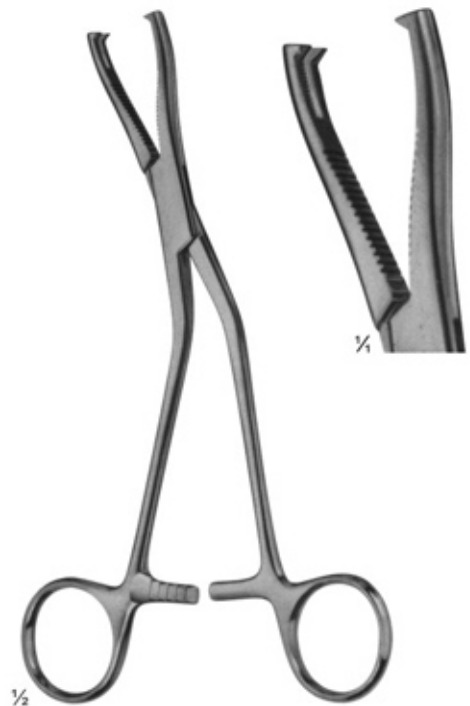

17-149
DINGMANN
185 mm

Bone Holding Forceps & Bone Clamps



Bone Rongeurs



17-158
LUER
150 mm



17-159
LUER
155 mm

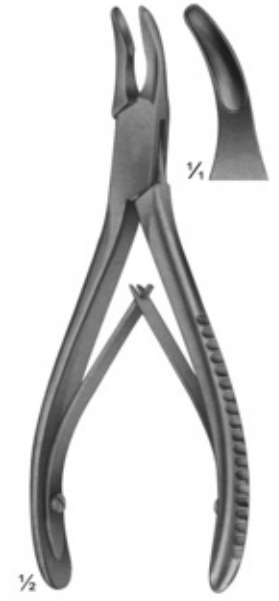

17-160
BLUMENTHAL
155 mm



17-161
BLUMENTHAL
150 mm



17-162 - 163
JANSEN
175 mm

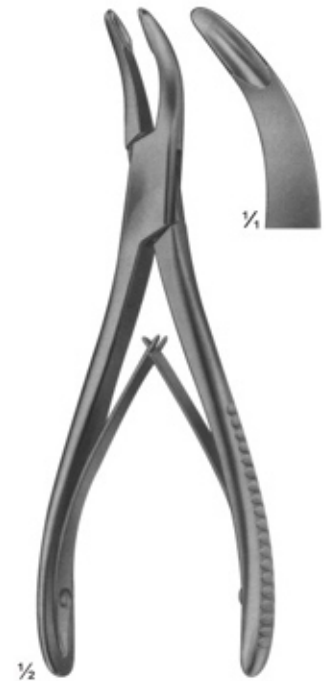

17-164
BANE-HARTMANN
175 mm

Bone Rongeurs



Bone Cutting Forceps

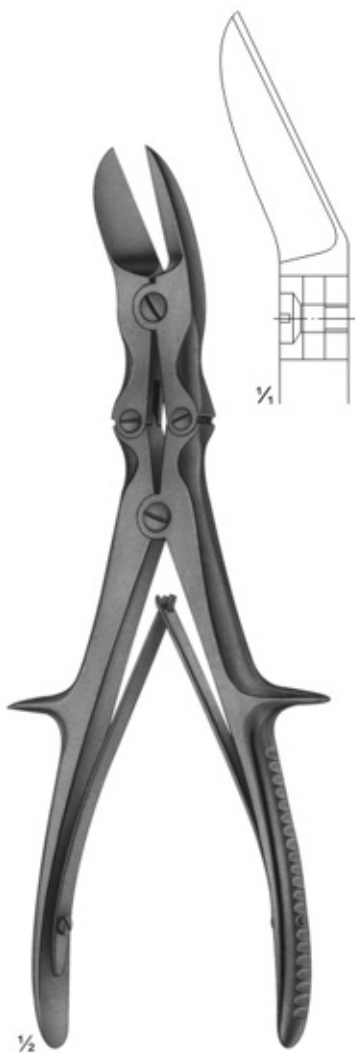

17-168
LISTON
curved on flat
240 mm

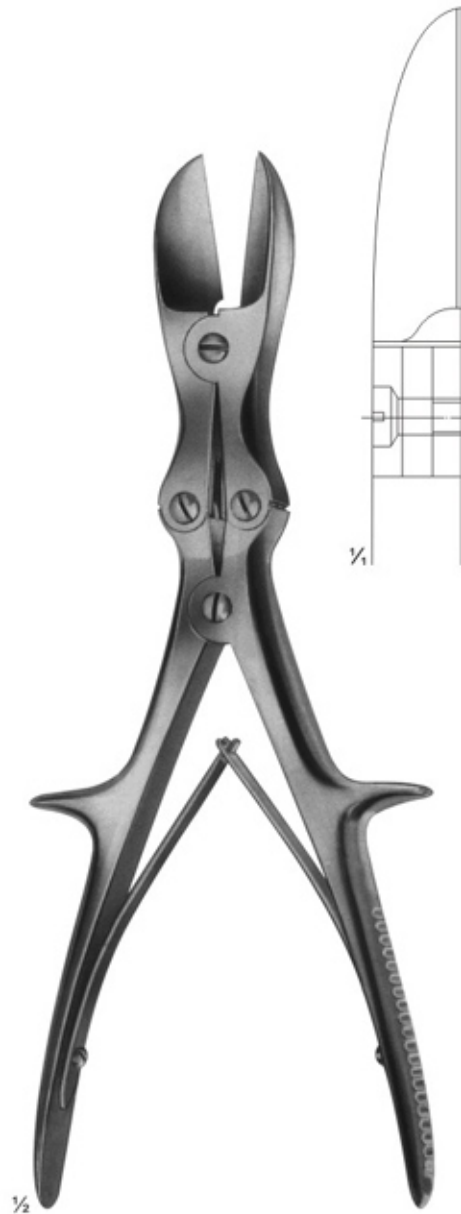

17-169
LISTON
straight
280 mm

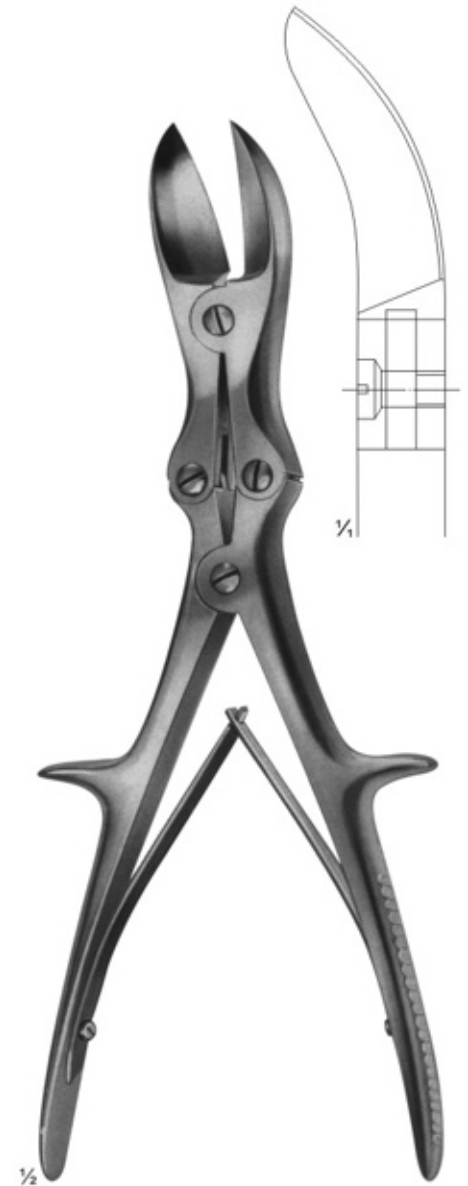

17-170
LISTON
curved on flat
280 mm

Wire Extension

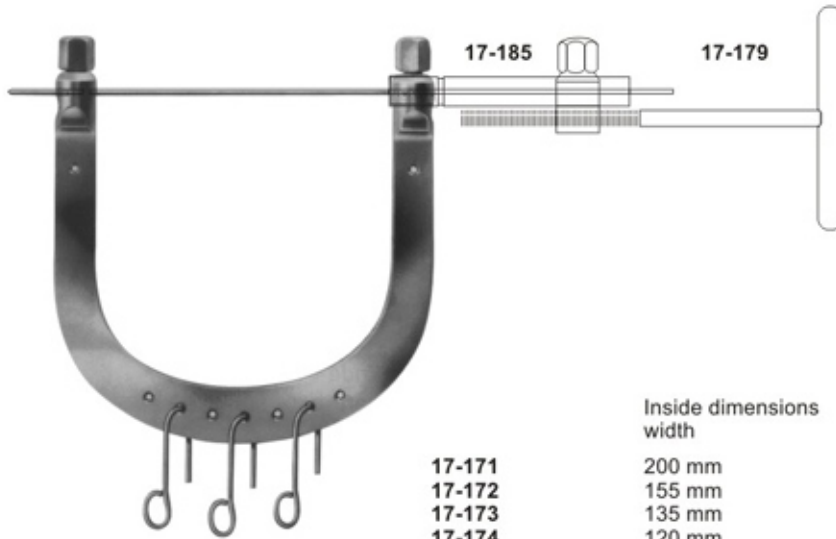

17-171 - 17-177
KIRSCHNER
 Wire traction bows,
 to be used with
 KIRSCHNER-wires
 up to 2.5 mm diam.,
 With 3 hooks,
 stainless steel

	Inside dimensions width	depth	
17-171	200 mm	155 mm	for the hip
17-172	155 mm	155 mm	for the femur
17-173	135 mm	130 mm	for the knee
17-174	120 mm	120 mm	for the knee
17-175	105 mm	100 mm	for the knee
17-176	95 mm	110 mm	for the calcaneus
17-177	95 mm	70 mm	for the arm and elbow



17-178
 Wrench, double - ended,
 for wire traction bows



17-179
 Wire tightener, with
 clamping jaws



17-182	max. 105 mm
17-183	max. 160 mm
17-184	max. 200 mm
17-182	80-95 mm
17-183	90-120 mm
17-184	140-170 mm
diam upto	
17-182	1,6 mm
17-183	2,0 mm
17-184	2,5 mm

17-182 - 17-184
KIRSCHNER
 Wire traction bows, modified,
 adjustable in width, holds wire
 securely, with 1 hook



17-180
 Traction hook only,
 large size



17-181
 Traction hook only,
 small size



17-185
 Fixation clamp, to secure clamping
 jaws of 17-179 stainless steel

Cerclage Instruments

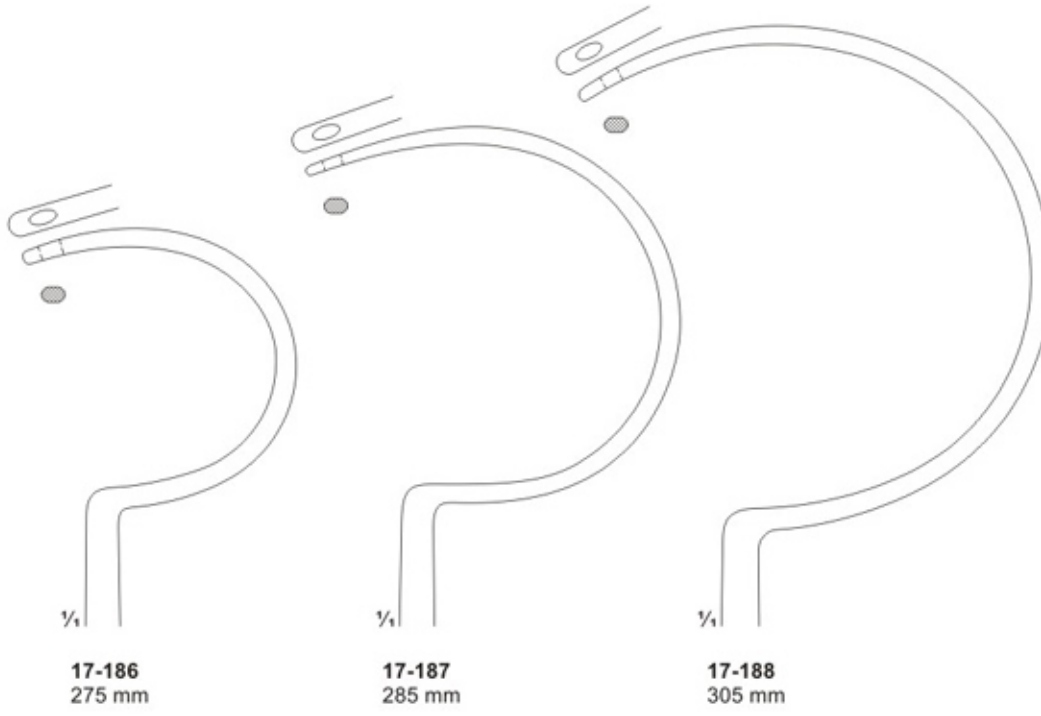

17-186
275 mm

17-187
285 mm

17-188
305 mm



17-186 - 17-188
DEMEL
Wire guides

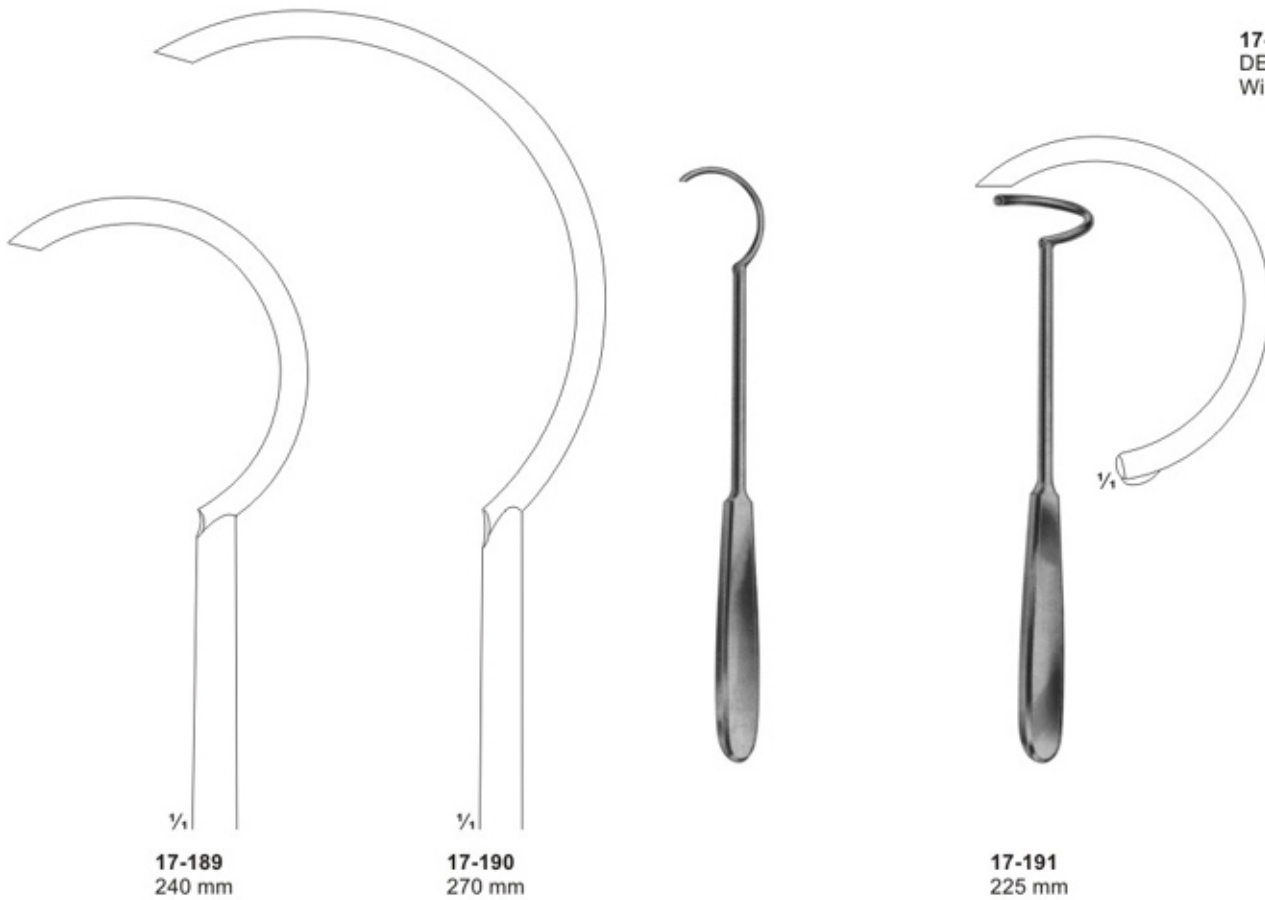

17-189
240 mm

17-190
270 mm

17-191
225 mm

Wire Holding forceps, Wire Tightening Pliers, Flat-nosed Pliers DUROGRIP with Hard Metal Inserts

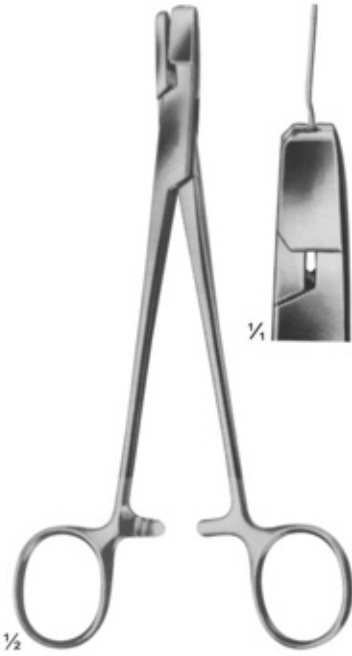

17-192
DUROGRIP
Holding forceps for cerclage wire, with lateral jaws to avoid wire slipping off
170 mm



17-193
DUROGRIP
Wire, tightening pliers, Ligature pliers
150 mm



17-194
DUROGRIP
Wire, tightening pliers, Ligature pliers
150 mm



17-195
with serrated jaws
140 mm



17-196
one jaw smooth, one jaw serrated
140 mm



17-197
with serrated jaws
17-198
with longitudinal and transversal grooves
170 mm



17-199
190 mm

Wire Holding forceps, Flat-nosed Pliers, Pliers for bending and cutting wires

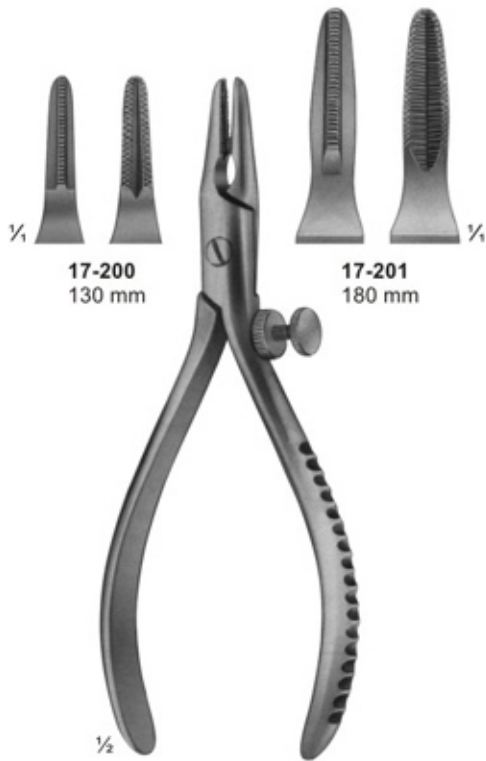

17-200
130 mm

17-201
180 mm

17-200 - 17-201
Extraction pliers
for boring wires



17-202
Flat-nosed pliers,
parallel
185 mm

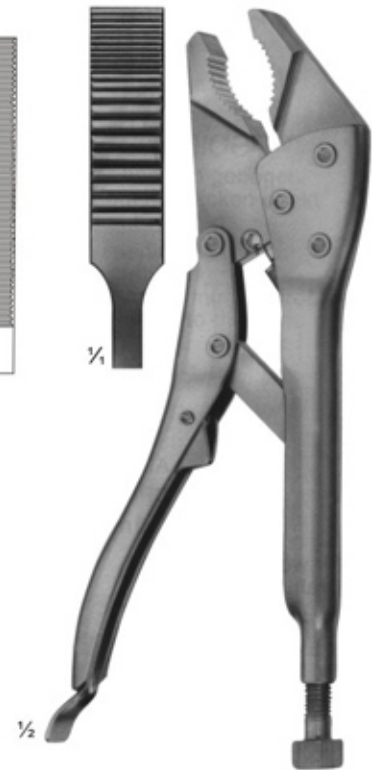

17-203
Vise grip
200 mm

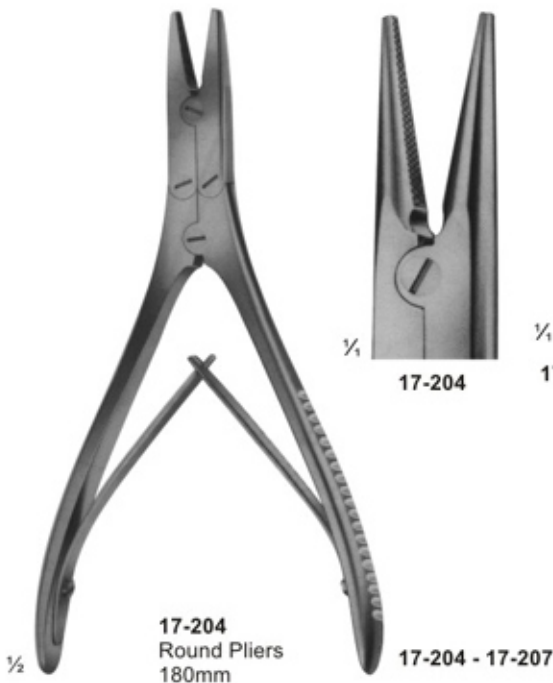

17-204
Round Pliers
180mm

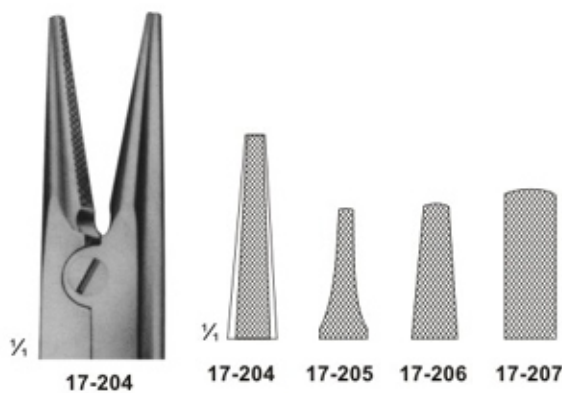

17-204

17-204

17-205

17-206

17-207

17-205 145 mm
17-206 180 mm
17-207 180 mm
Extraction pliers for wires



17-208
Bending pliers
for wires up to
1.8 mm diam.

Wire Cutters and wire Cutting Scissors DUROTIP with Carbide Cutting Edges



17-209
ANGLE
130 mm

for soft wire
up to diam.
for hard wire
up to diam.

0,5 mm
0,3 mm

17-210
DUROTIP
ANGLE
130 mm

0,6 mm
0,4 mm

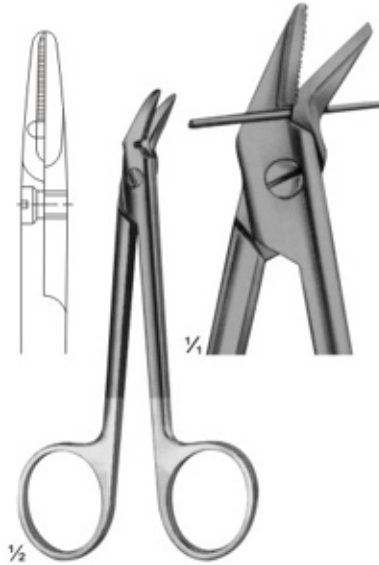

17-211
120 mm

for soft wire
up to diam.
for hard wire
up to diam.

1,2 mm
0,8 mm

17-212
DUROTIP
120 mm

1,2 mm
0,8 mm

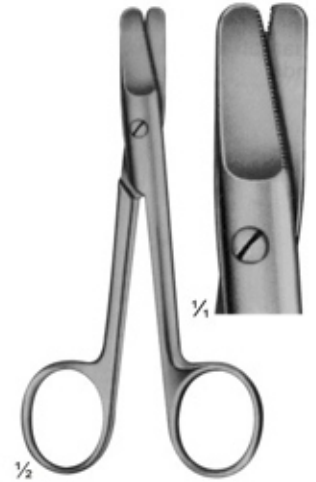

17-213
HARVEY
125 mm

0,4 mm
0,3 mm



17-214
150 mm

for soft wire
up to diam
for hard wire
up to diam

1,5 mm
1,0 mm



17-215
160 mm

1,5 mm
1,2 mm



17-216
140 mm
DUROTIP
1,5 mm

1,0 mm

Wire Cutting Pliers, Lateral Cutting Action



17-217
180 mm

for soft wire
up to diam. 2,0 mm
For hard wire 1,5 mm
up to diam
specially hardened
cutting edges, front
and lateral cutting
action



17-218
REILL
175 mm

for soft wire
up to diam. 2,0 mm
For hard wire 1,6 mm
up to diam
specially hardened
cutting edges, for
cutting off wires close
to the bone



DUROTIP

17-219
235 mm

for soft wire
up to diam. 3,0 mm
For hard wire 2,2 mm
up to diam

Wire Cutting Pliers, Lateral and Front Cutting Action



17-220
240 mm

for soft wire up to diam. 2,0 mm
For hard wire up to diam 1,6 mm



17-221
145 mm

for soft wire up to diam. 1,5 mm
For hard wire up to diam 1,0 mm



17-222
145 mm

for soft wire up to diam. 2,0 mm
For hard wire up to diam 1,5 mm



17-223
220 mm

for soft wire up to diam. 3,5 mm
For hard wire up to diam 2,5 mm

Wire Cutting Pliers



17-224
320 mm

for soft wire
up to diam. 3,0 mm
For hard wire
up to diam 3,0 mm



Cutter for cutting off
KIRSCHNER wires,
Tibia head screws,
bolts, pins, up to 3 mm diam.



DUROTIP

17-225
Cutter for cutting off
KIRSCHNER wires,
Tibia head screws,
bolts, pins, up to 6 mm diam.
470 mm

Finger Nail Instruments

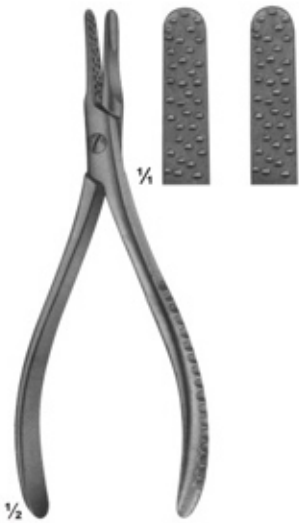

17-226
Nail extracting
forceps
135 mm



17-227
Nail extracting
forceps
145 mm

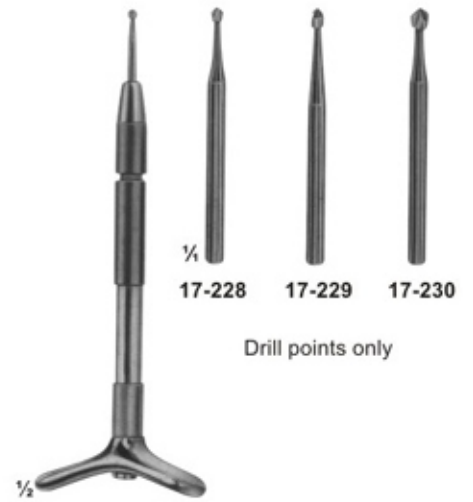

17-228
Finger nail drill
with 3 drill points

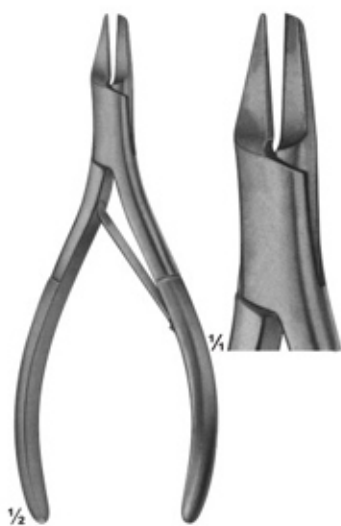

17-231
Nail splitting
forceps
135 mm



17-232
SYSTRUNK
Scissors, for splitting
finger nails
130 mm



17-233
Finger ring saw
150 mm

Spare blade
17-234

Plaster Shears



17-235
STILLE-AESFULAP
260 mm



17-236
STILLE-AESFULAP
360 mm

Plaster Spreader, Plaster Breakers



17-237
HENING
270 mm



17-238
MOD.USA
230 mm



17-239
290 mm



with removable jaws



17-240 - 17-241
WOLFF
17-240 180 mm
17-241 240 mm
plaster breakers

Vacuum Curettes for Aspiration Lipectomy, Suction Instruments

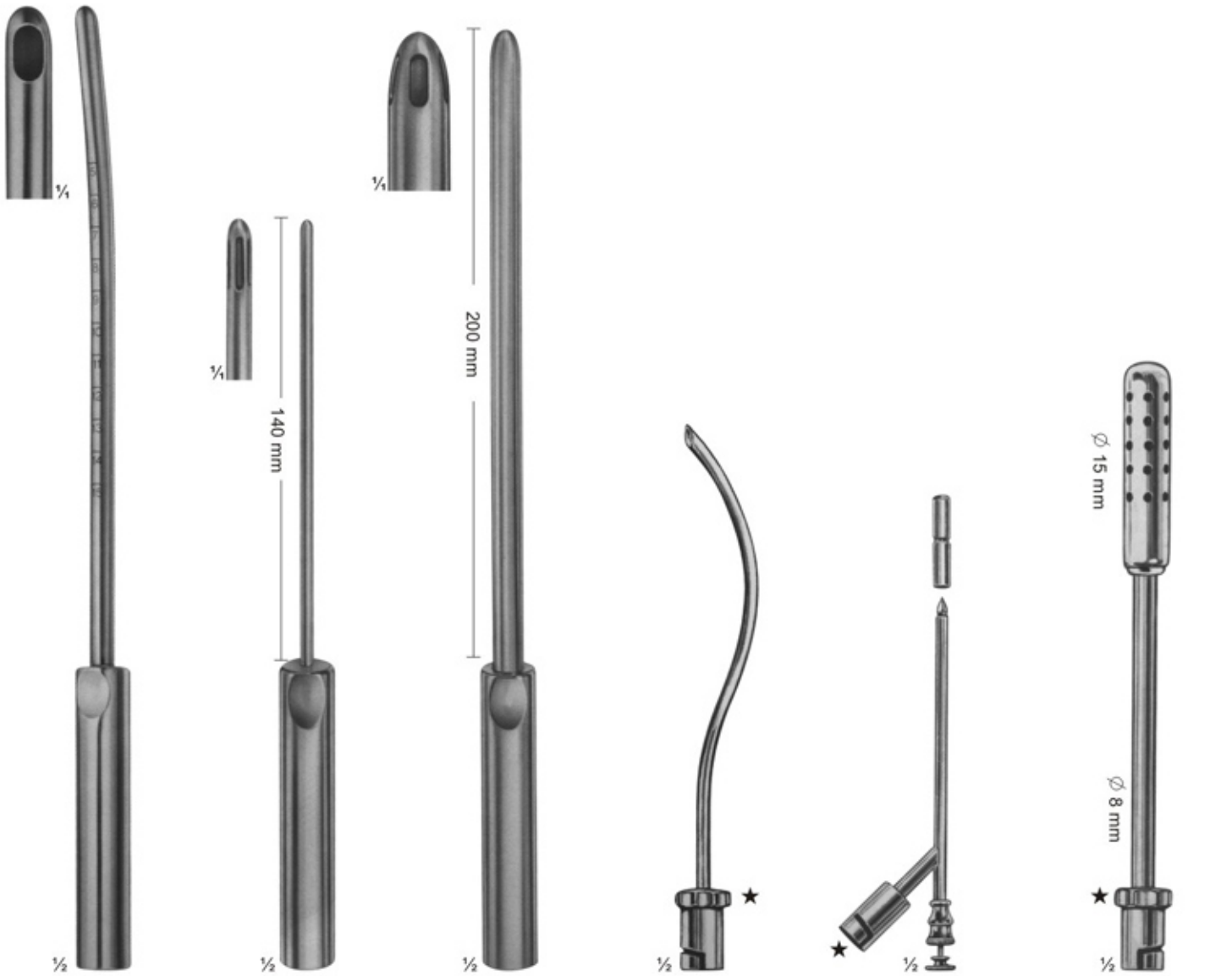

18-101 - 18-106
BIEMER
 18-101 \varnothing 4 mm
 18-102 \varnothing 6 mm
 18-103 \varnothing 8 mm
 18-104 \varnothing 10 mm
 18-105 \varnothing 12 mm
 18-106 \varnothing 14 mm
 Curettes for aspiration lipectomy, graduated, slightly curved

18-107 - 18-108
BIEMER
 18-107 \varnothing 4 mm
 18-108 \varnothing 6 mm
 Curettes for aspiration lipectomy, with three apertures, slightly curved malleable

18-109 - 18-111
BIEMER
 18-109 \varnothing 8 mm
 18-110 \varnothing 10 mm
 18-111 \varnothing 12 mm
 Curettes for aspiration lipectomy, with three apertures, slightly curved malleable

18-112
 For aspirating fluid from the excretory ducts of large glands and for keeping the operating area clear
 170 mm

18-113
Trocar
 For puncturing
 150 mm

18-114
 For clearing large quantities of fluid
 190 mm

Suction Instruments

18-115 150mm
Suction handle, with vacuum regulator and finger cut-off, brass, mirror-finish chromium-plated

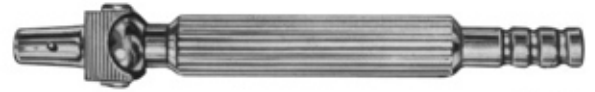

olive
Ø9 mm

18-116 170mm
Suction handle, with hand regulation valve and quick-shutter, brass, mirror-finish chromium-plated



Both suction handles have bayonet fitting olive and can be used for the suction cannulae. Ø9 mm



18-117
Trocar
For puncturing
170 mm



18-118
Hollow needle,
sharp
150 mm



18-119
double curved
For general
surgery
230 mm



18-120
For tonsillectomy,
oral and laryngeal
operations
190 mm



18-121
For tonsillectomy,
oral and laryngeal
operations
220 mm

★ With bayonet fitting to be used with suction handles (18-115 - 18-116)

Suction Instruments

18-122
WULLSTEIN
Suction tube, conical, silver, olive
with LUER hub
160 mm



18-123 1,5 mm
18-124 2,0 mm
WULLSTEIN
Suction tube, cylindrical, silver, with
stylet olive with LUER hub
160 mm



Usable length

YASARGIL usable length diam.		YASARGIL usable length diam.	
18-125	130 mm 1,5 mm	18-133	130 mm 2,5 mm
18-126	150 mm 1,5 mm	18-134	150 mm 2,5 mm
18-127	180 mm 1,5 mm	18-135	180 mm 2,5 mm
18-128	220 mm 1,5 mm	18-136	220 mm 2,5 mm
18-129	130 mm 2,0 mm	18-137	130 mm 3,5 mm
18-130	150 mm 2,0 mm	18-138	150 mm 3,5 mm
18-131	180 mm 2,0 mm	18-139	180 mm 3,5 mm
18-132	220 mm 2,0 mm	18-140	220 mm 3,5 mm
		18-141	180 mm 4,5 mm

olive
Ø 6,5-9 mm
with LUER hub

18-142 - 18-144
LANDOLT
150 MM
diam Ø 3 mm

18-142 8 mm / curved
18-143 11mm / curved
18-144 15mm / curved

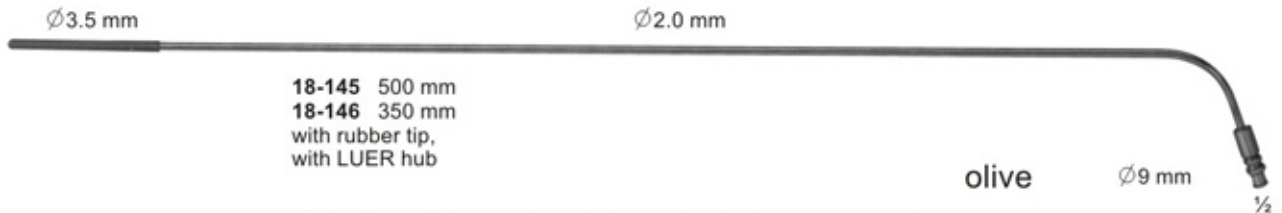
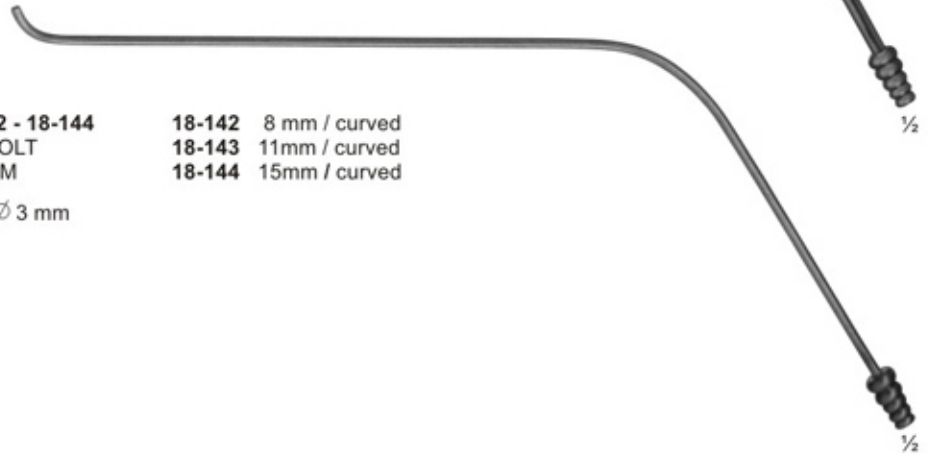

18-145 500 mm
18-146 350 mm
with rubber tip,
with LUER hub

18-147 2,0 mm diam
18-148 2,5 mm diam
18-149 3,0 mm diam
with finger cut-off,
thumb piece 90° to
curve, with LUER hub
250 mm



Combined Suction and Irrigation Cannulae, Coagulation Suction Cannulae

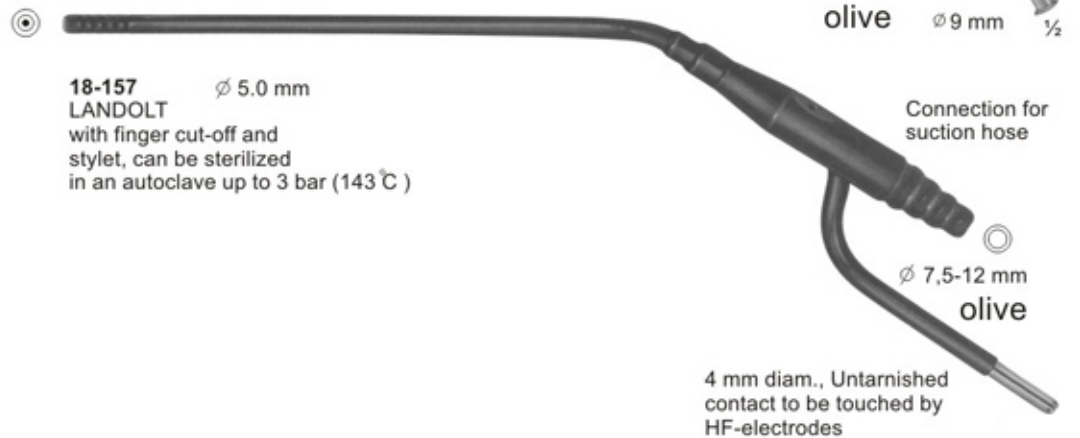
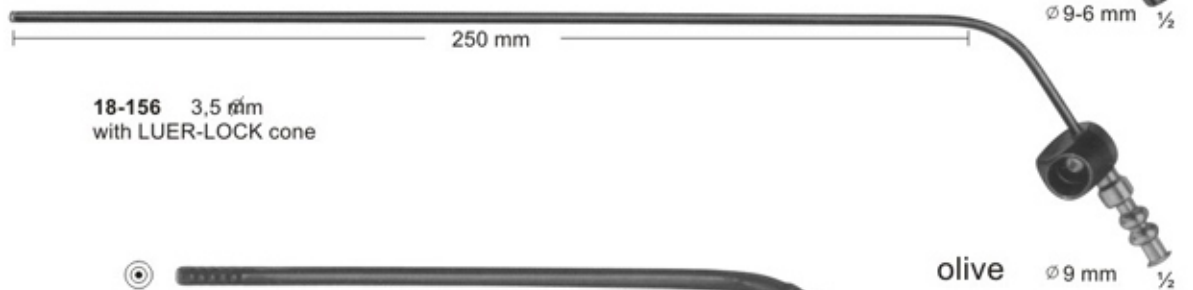
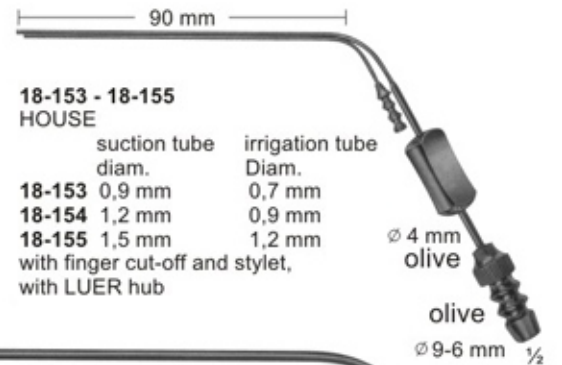
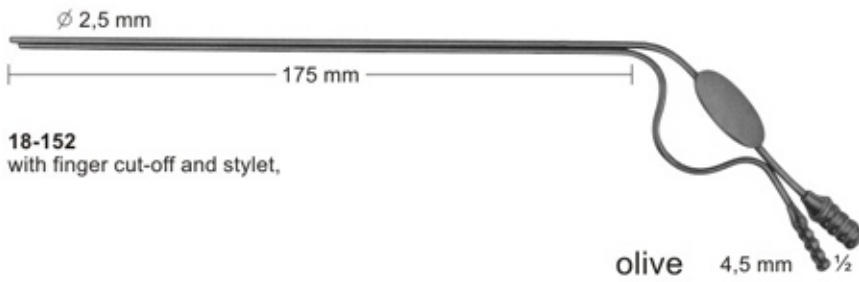
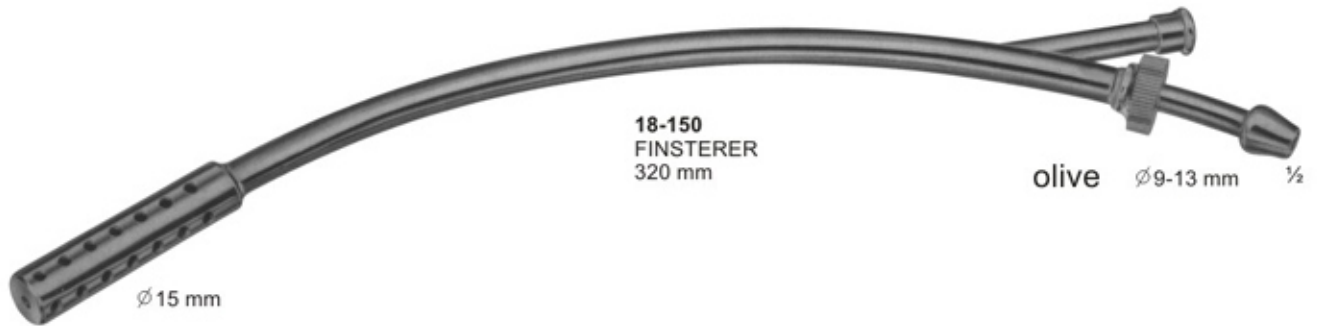

Suction Instruments

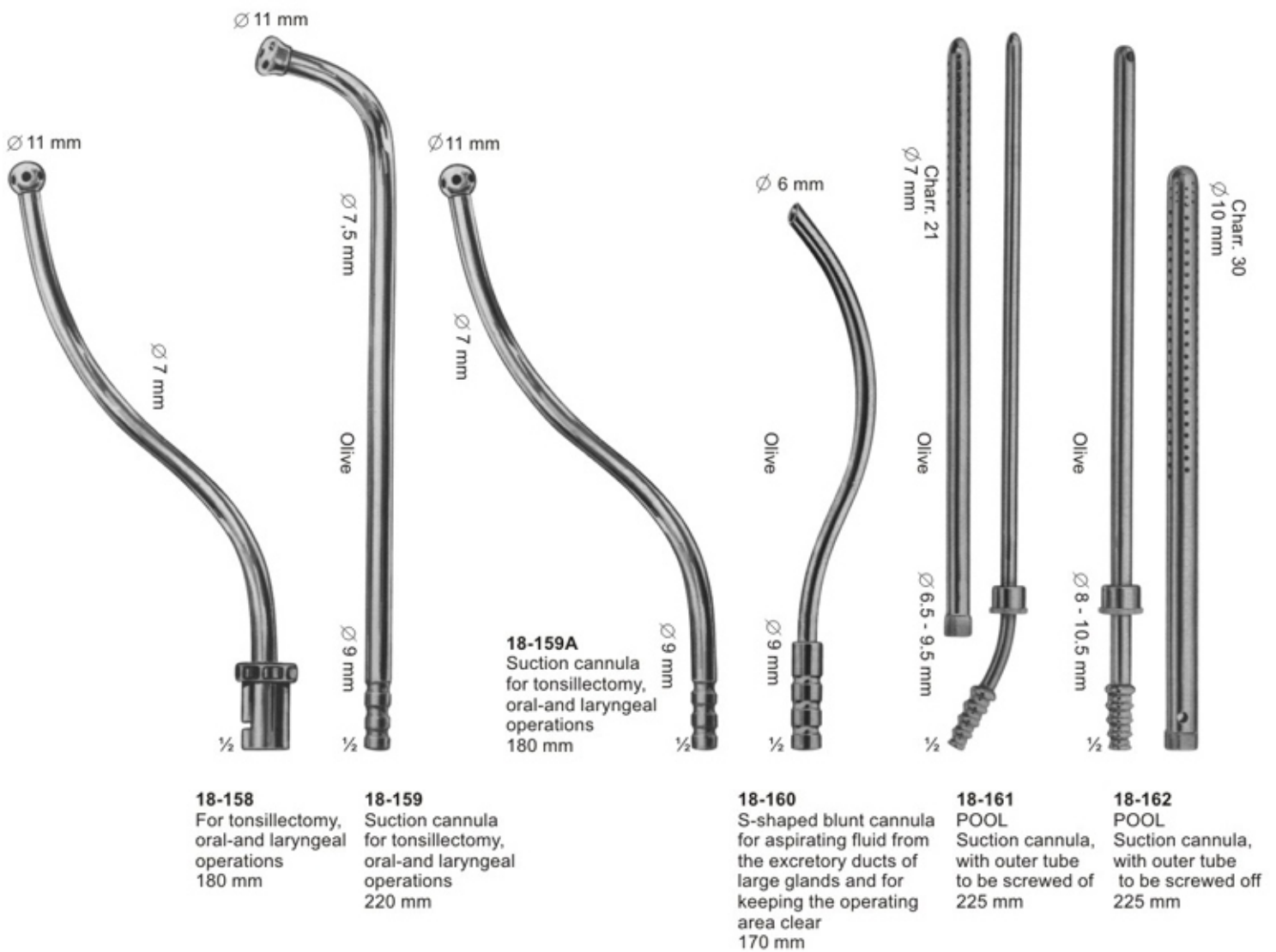

Suction Instruments

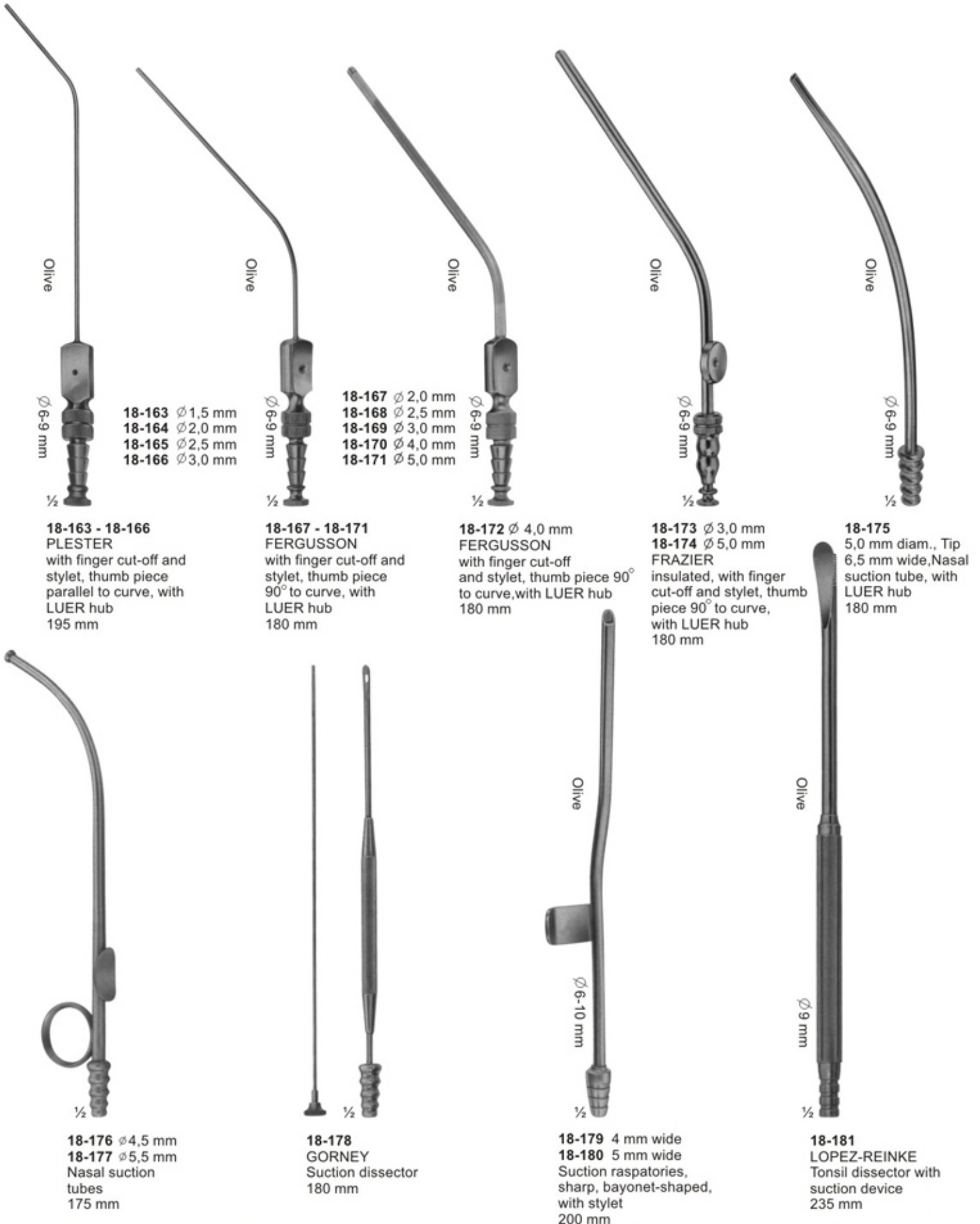

18-163 - 18-166
PLESTER
 with finger cut-off and stylet, thumb piece parallel to curve, with LUER hub
 195 mm

18-163 \varnothing 1,5 mm
18-164 \varnothing 2,0 mm
18-165 \varnothing 2,5 mm
18-166 \varnothing 3,0 mm

18-167 - 18-171
FERGUSON
 with finger cut-off and stylet, thumb piece 90° to curve, with LUER hub
 180 mm

18-167 \varnothing 2,0 mm
18-168 \varnothing 2,5 mm
18-169 \varnothing 3,0 mm
18-170 \varnothing 4,0 mm
18-171 \varnothing 5,0 mm

18-172 \varnothing 4,0 mm
FERGUSON
 with finger cut-off and stylet, thumb piece 90° to curve, with LUER hub
 180 mm

18-173 \varnothing 3,0 mm
18-174 \varnothing 5,0 mm
FRAZIER
 insulated, with finger cut-off and stylet, thumb piece 90° to curve, with LUER hub
 180 mm

18-175
 5,0 mm diam., Tip 6,5 mm wide, Nasal suction tube, with LUER hub
 180 mm

18-176 \varnothing 4,5 mm
18-177 \varnothing 5,5 mm
 Nasal suction tubes
 175 mm

18-178
GORNEY
 Suction dissector
 180 mm

18-179 4 mm wide
18-180 5 mm wide
 Suction raspatories, sharp, bayonet-shaped, with stylet
 200 mm

18-181
LOPEZ-REINKE
 Tonsil dissector with suction device
 235 mm

Dissection Instruments

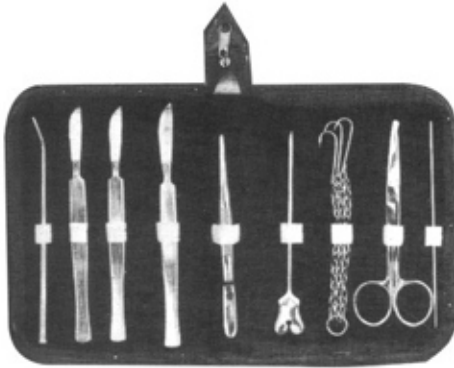

18-182

- 1- Blow pipe .
- 2- 3 PCS .scalpel.
- 3- Dissecting forcep 13 cm.
- 4- Grooved director with tounge tie 13 cm.
- 5- Triple chain hook.
- 6- Dressing scissors probe pointed 13 cm.
- 7- Probe double 13 cm.
- 8- Zipper case inside red velvet.

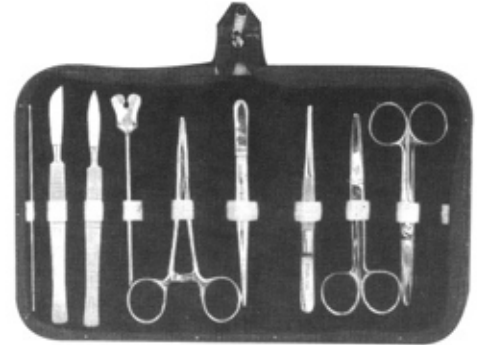

18-183

- 1- Probe Double 13 cm
- 2- 2 PCS. Scalpel S.S
- 3- Grooved Director With tongue Tie 13 cm
- 4- Mayo Hegar Needle Holder 13cm
- 5- Dissecting Forcep 13 cm 1x2 Teeth
- 6- Dressing Forcep 13 CMS Serrated.
- 7- Dressing Scissor 13 cm S/B STR.
- 8- Dressing Scissor 13 cm S/B CVD.
- 9- Zipper Case Inside Red Velvet.

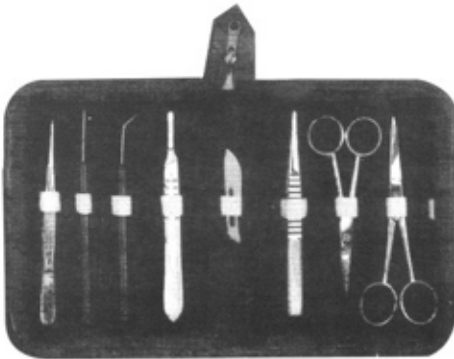

18-184

- 1- Dissecting Forcep 11.5 cm Sharp Point.
- 2- Iris Scissor
- 3- B.P Handle No. 4
- 4- Teasing Needle Sharp angular.
- 5- Blade No. 22
- 6- Thumb Forceps T.O.E 13 cm
- 7- Dissecting Scissor STR 11.5 cm
- 8- Dissecting Scissor STR 13 cm
- 9- Zipper case Inside Red Velvet

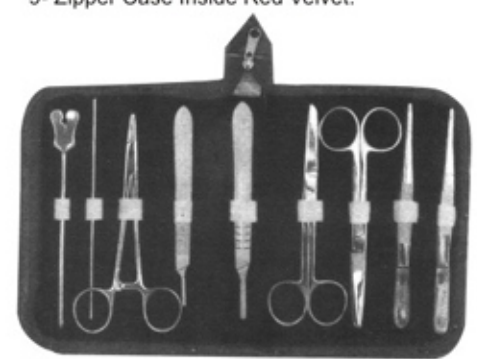

18-185

- 1- Grooved Director with Tongue Tie 14 cm
- 2- Probe Double 14cm
- 3- Mayo Hegar Needle Holder 14 cm
- 4- BP. Handle no.3
- 5- BP. Handle no.4
- 6- Dressing Scissor 14 cm S/B STR
- 7- Dressing Scissor 14 cm S/B CVD.
- 8- Dressing Forcep 1x2 Teeth 14 cm
- 9- Dressing Forcep Serrated 14 cm

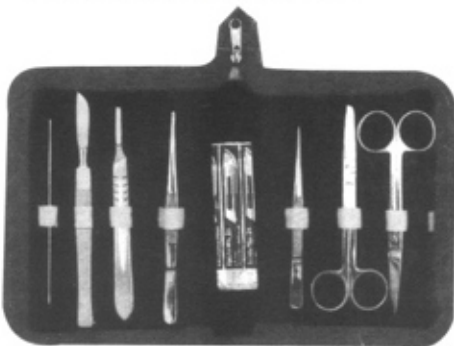

18-186

- 1- Probe double 12.5 cm
- 2- Scalpel
- 3- B.P Handle No. 4
- 4- 6 PCS Blade 2 each no. 21, 22, 23
- 5- Dissecting Forcep 12.5 cm
- 6- Dissecting Forcep 11.5 cm sharp Point
- 7- Dissecting Scissor S/B STR 13 cm
- 8- Dissecting Scissor S/S STR 13 cm

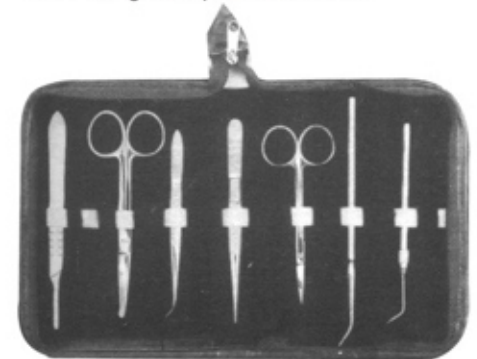

18-187

- 1- Teasing Needle with Chuck CVD.
- 2- Huber Probe
- 3- Iris Scissor
- 4- Dissecting Forcep Fine 14 cm.
- 5- Dissecting Forcep Fine CVD. 12 cm
- 6- Operating Scissor with Probe 14 cm.
- 7- B.P. Handle no. 4

Dissection Instruments



18-188

- 1- Probe with eye
- 2- Dissecting Forcep cvd fine 12 cm.
- 3- Iris Scissor
- 4- Operating Scissor S/B str 14 cm
- 5- Grooved Director and Tongue tie
- 6- Huber Probe
- 7- Triple Chain Hook
- 8- B.P Handle No. 4
- 9- B.P Handle No. 3
- 10- Teasing Needle with Chuck cvd.
- 11- Teasing Needle with Chuck str.
- 12- Dissecting Forceps Fine 14 cm.

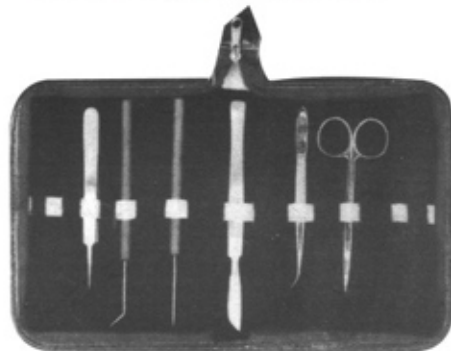

18-190

- 1- Iris Scissor STR
- 2- Dissecting Forceps CVD 12 cm.
- 3- Scalpel
- 4- Teasing Needle STR wooden handle.
- 5- Teasing Needle CVD wooden handle.
- 6- Watchmaker fine point.

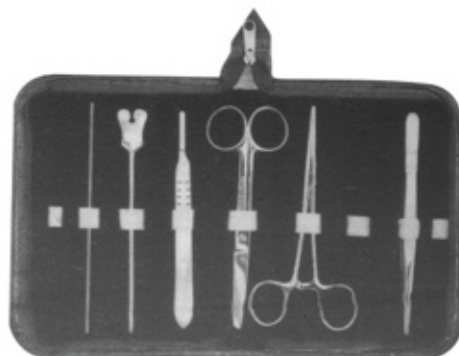

18-192

- 1- Probe double end.
- 2- Grooved director and tounge tie.
- 3- B.P handle no.4
- 4- Operating scissor STR S/b14cm.
- 5- Kelly forceps STR 14cm.
- 6- Dissecting forceps thumb 13cm.

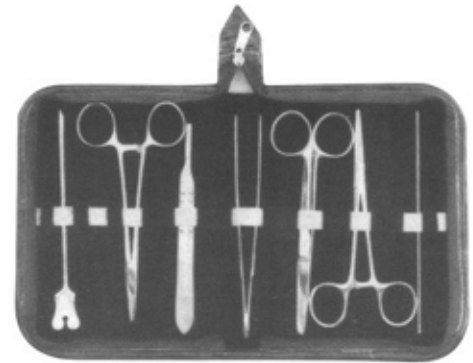

18-189

- 1- Grooved Director and Tongue tie
- 2- Mayo Hearg Needle Holder 14 cm
- 3- B.P Handle No. 4
- 4- Dissecting Forceps Thump 14 cm.
- 5- Operating Scissor S/B str 14 cm
- 6- Kelly Forcep STR 14 cm.
- 7- Probe Double end

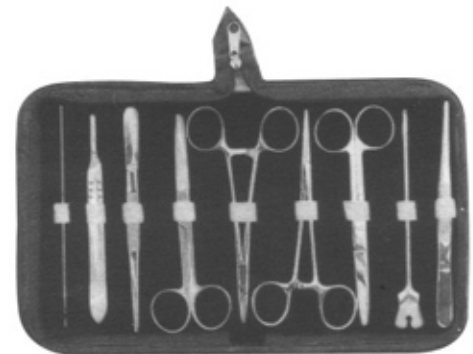

18-191

- 1- Probe Double end
- 2- B.P Handle No. 4
- 3- Dissecting Forcep 1x2 Teeth 14 cm.
- 4- Operating Scissor S/B str 14 cm
- 5- Mayo Hearg Needle Holder 14 cm
- 6- Kelly Forcep STR 14 cm.
- 7- Operating Scissor S/B CVD 14 cm
- 8- Grooved Director and Tongue tie
- 9- Dissecting Forceps Thumb 14 cm.

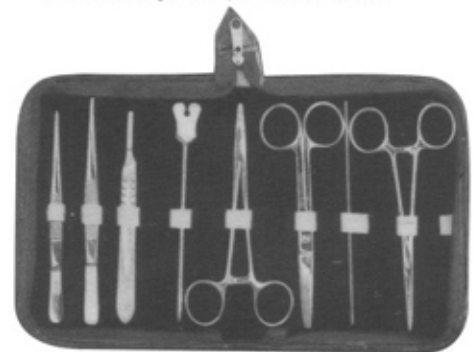

18-193

- 1- Dissecting Forceps Thumb 14 cm
- 2- Dissecting Forcep 1x2 Teeth 14 cm.
- 3- B.P Handle No. 3
- 4- Grooved Director and Tongue tie
- 5- Mayo Hearg Needle Holder 14 cm
- 6- Operating Scissor S/B str 14 cm
- 7- Probe Double end
- 8- Kelly Forcep STR 14 cm.

Dissection Instruments

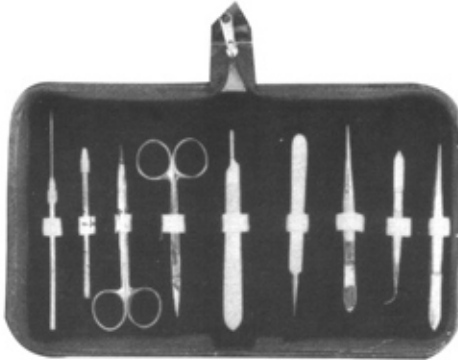

18-194

- 1- Dissecting Forcep Fine 14cm.
- 2- Dissecting Forcep Fine CVD 12cm
- 3- Dissecting Forcep with Pin 14cm.
- 4- Watchmaker Fine point
- 5- Iris scissor STR
- 6- Iris scissor CVD.
- 7- Teasing Needle holder
- 8- Teasing Needle STR.
- 9- B.P. Handle no. 3



18-195

- 1- Teasing Needle STR.
- 2- Grooved Director and Tongue Tie.
- 3- Teasing Needle CVD.
- 4- Dissecting Forcep with Pin 12 cm Fine
- 5- Operating Scissor S/B STR 14 cm
- 6- Triple Chain Hook
- 7- Probe with eye
- 8- Probe Double end
- 9- Probe and Hook
- 10- Dissecting Forcep Fine 14 cm
- 11- Iris Scissor
- 12- Huber Probe
- 13- B.P. Handle no.3
- 14- B.P. Handle no.4



18-196

- 1- Dissecting forcep fine STR with pin 12cm.
- 2- Iris scissor STR.
- 3- Probe with eye.
- 4- Probe and hook.
- 5- Operating scissor S/B STR 14cm
- 6- Triple chain hook.
- 7- B.P. handle no.4
- 8- Humber probe.
- 9- B.P.handle no.3
- 10- Teasing needle STR plastic handle.
- 11- Teasing needle CVD plastic handle.
- 12- Grooved director and tongue tie.
- 13- Probe double end.



18-197

- 1- Dissecting Forceps Thumb 14 cm.
- 2- Dissecting Forcep 1x2 Teeth 14 cm.
- 3- B.P Handle No. 3
- 4- Grooved Director and Tongue tie
- 5- Mayo Hearn Needle Holder 14 cm
- 6- Operating Scissor S/B str 14 cm
- 7- Probe Double end
- 7- Kelly Forcep STR 14 cm.

Hospital Wares



19-101 - 115
Schimmelbusch

	Ø x H sizes in mm
19-101	80 x 80
19-102	105 x 120
19-103	140 x 140
19-104	160 x 120
19-105	160 x 150
19-106	190 x 150
19-107	190 x 190
19-108	240 x 160
19-109	240 x 240
19-110	290 x 160
19-111	290 x 240
19-112	340 x 160
19-113	340 x 340
19-114	390 x 190
19-115	390 x 290



19-116
Box
120 x 65 x 13mm
(without Bulldog clamps,
without silicone tape)



19-117
Box with support
120 x 65 x 13 mm
(ohne Bulldogklemmen)



19-118
Box with support for
needle electrodes,
without instruments

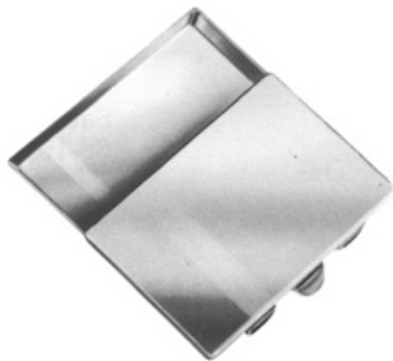

19-119 - 121
50 x 25 x 4,5 mm
19-120
65 x 42 x 8 mm
19-121
75 x 25 x 4,5 mm



19-122
Ø 65mm x 15mm

Hospital Wares



19-123 - 131

	Ø x H
19-123	30 x 90 mm
19-124	50 x 100 mm
19-125	50 x 130 mm
19-126	50 x 175 mm
19-127	75 x 100 mm
19-128	75 x 130 mm
19-129	75 x 175 mm
19-130	100 x 175 mm
19-131	100 x 200 mm



19-141 - 142

- 19-141** Martin Sterilizing Forceps consisting of:
1 Sterilizing Forceps, curved, 25 cm, without ratchet, with lid for jar
1 jar with bottom plate (anti-tilt)
- 19-142** ditto, with 32 cm long Sterilizing Forceps



19-132 - 139

19-132	165 x 85 x 35 mm
19-133	200 x 100 x 35 mm
19-134	200 x 100 x 50 mm
19-135	230 x 130 x 50 mm
19-136	260 x 150 x 50 mm
19-137	270 x 235 x 50 mm
19-138	300 x 200 x 50 mm
19-139	325 x 275 x 50 mm



19-140
205 x 105 x 35 mm

Round Metal Boxes and Medicine Cups



19-143 - 148

	Ø x H
19-143	75 x 60 mm
19-144	75 x 75 mm
19-145	100 x 60 mm
19-146	100 x 100 mm
19-146A	125 x 80 mm
19-147	125 x 125 mm
19-148	150 x 150 mm



19-149
25 cc

19-150
50 cc



19-151
20 cc
Medicine Spoon



19-152
Ø 75 x 12 mm
Tablet Tray



19-153
Ø 90 x 90 mm
Metal Cup



19-154
Ø 75 x 80 mm
Sputum Cup



Kidney Dish



19-155 - 157

19-155	170 x 100 x 35 mm
19-156	250 x 140 x 40 mm
19-157	275 x 150 x 45 mm

Hospital Wares



19-158 - 165



19-166 - 170

	Ø x H	
19-158	40 x 19 mm	0.05L
19-159	61 x 30 mm	0.07L
19-160	80 x 40 mm	0.14L
19-161	116 x 50 mm	0.35L
19-162	128 x 55 mm	0.45L
19-163	147 x 65 mm	0.70L
19-164	167 x 75 mm	1.10L
19-165	187 x 85 mm	1.60L

19-166	116 x 35 mm	0.30L
19-167	128 x 38 mm	0.40L
19-168	147 x 40 mm	0.50L
19-169	157 x 45 mm	0.75L
19-170	187 x 45 mm	1.00L



19-171
Ø 110 x 28 mm 0.15L



19-172
100 cc 0.1L



19-173 - 176
19-173 0,25L
19-174 0,50L
19-175 1,00L
19-176 2,00L



19-177
235 x 190 x 40 mm



19-178
Ø 220 x 70 mm

Hospital Wares



19-179
 ∅ 50 x 100 mm
 Powder Pot



19-180
 ∅ 50 x 75 mm
 Methot With Lid



19-181
 ∅ 50 x 75 mm
 Methot Without Lid



19-182



19-183



19-184



19-185 - 186

19-185 ∅ 235 mm
19-186 ∅ 310 mm

Needle Cases



19-187
Sauerbruch
210 x 125 x 17 mm



19-188
Sauerbruch
210 x 125 x 17 mm



19-189
150 x 95 x 13 mm



19-190
150 x 95 x 13 mm



19-191
150 x 95 x 13 mm



19-192
150 x 95 x 13 mm



19-193
150 x 95 x 13 mm



19-194
150 x 95 x 13 mm



19-195
150 x 95 x 11 mm

Storing Cases



19-199 - 209

19-199	230 x 130 x 50	mm
19-200	260 x 150 x 50	mm
19-201	275 x 235 x 50	mm
19-202	300 x 200 x 50	mm
19-203	325 x 275 x 50	mm
19-204	420 x 175 x 50	mm
19-205	230 x 130 x 75	mm
19-206	260 x 150 x 75	mm
19-207	300 x 200 x 75	mm
19-208	325 x 275 x 75	mm
19-209	420 x 175 x 75	mm



19-196
Deponette
245 x 135 x 35mm



19-197
Deponette
245 x 135 x 50mm



19-198
Deponette
245 x 135 x 60mm

Sterilizing Baskets / Trays



19-210 - 212

19-210	480 x 250 x 50	mm
19-211	520 x 250 x 75	mm
19-212	520 x 250 x 100	mm

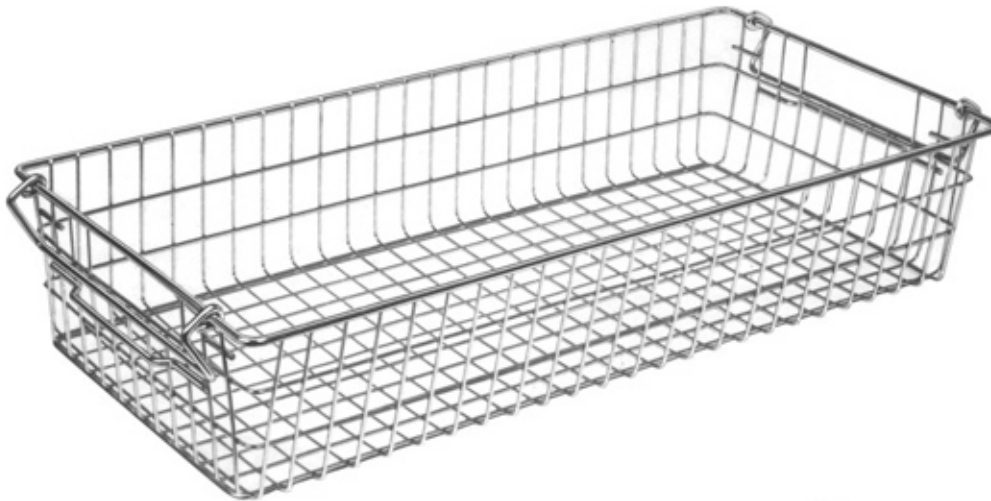

19-219
(60 x 30 x 15 cm)
Nominal dimensions



19-213 - 218

19-213	240 x 240 x 50	mm
19-214	240 x 240 x 80	mm
19-215	240 x 240 x 100	mm
19-216	480 x 260 x 50	mm
19-217	520 x 260 x 80	mm
19-218	520 x 260 x 100	mm

Scissors with Tungsten Carbide Inserts



26-101
Standard

14,5cm
16,5cm
18,5cm



26-102
Standard

14,5cm
16,5cm
18,5cm



26-103
Standard

14,5cm
16,5cm
18,5cm



26-104
Standard

14,5cm
16,5cm
18,5cm



26-105
Standard

14,5cm
16,5cm
18,5cm



26-106
Standard

14,5cm
16,5cm
18,5cm

Scissors with Tungsten Carbide Inserts

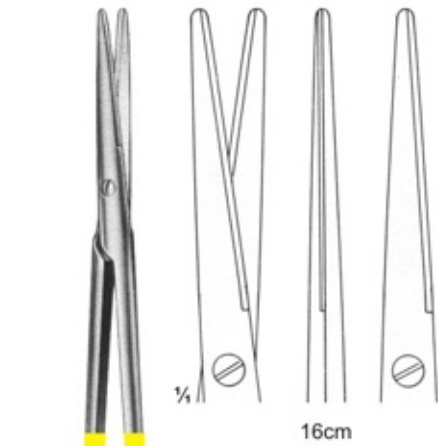

1/2
26-107
 Mayo-Lexer

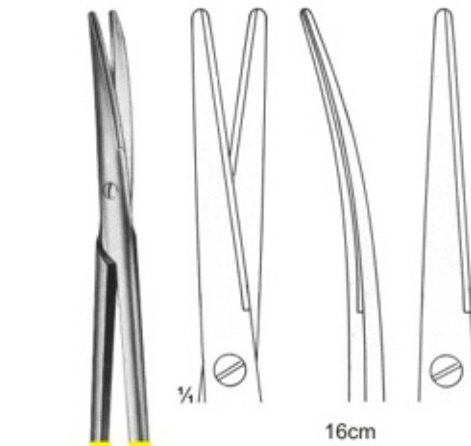

1/2
26-108
 Mayo-Lexer

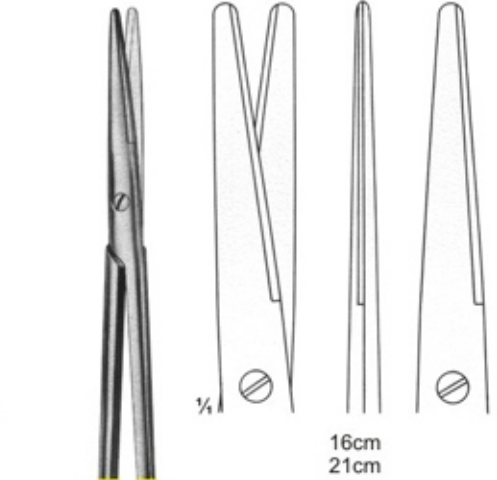

1/2
26-109
 Lexer

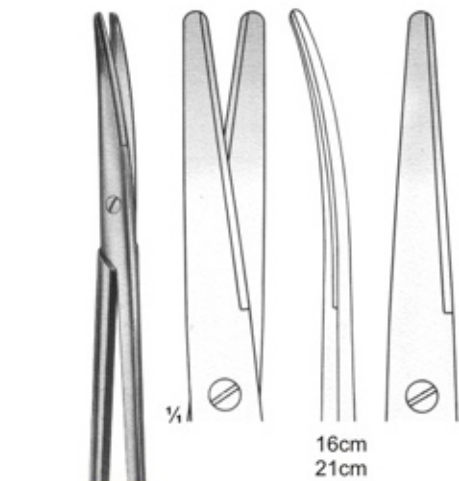

1/2
26-110
 Lexer

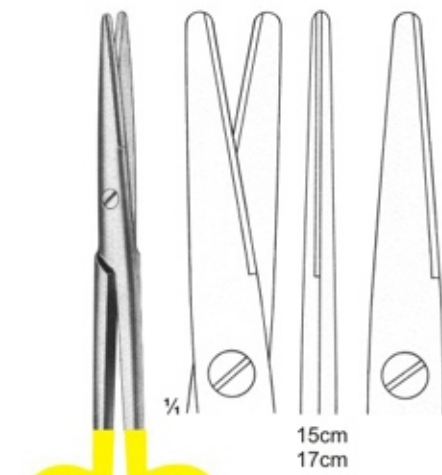

1/2
26-111
 Mayo-Stille

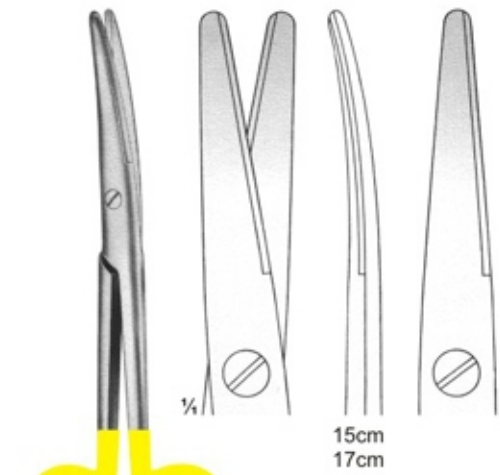

1/2
26-112
 Mayo-Stille

Scissors with Tungsten Carbide Inserts

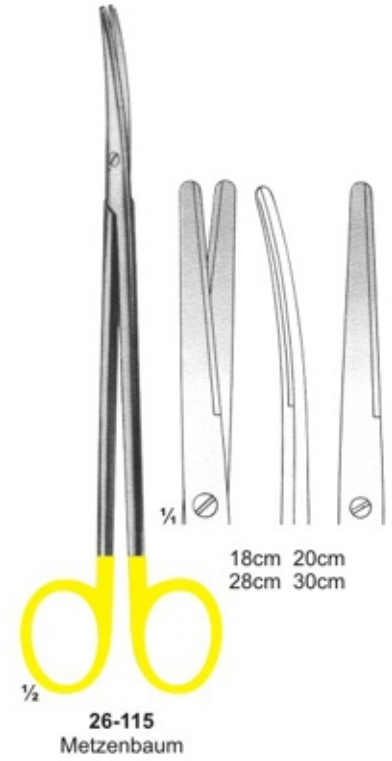
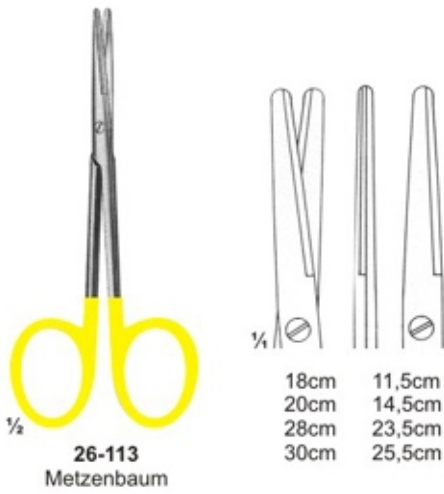

Scissors with Tungsten Carbide Inserts

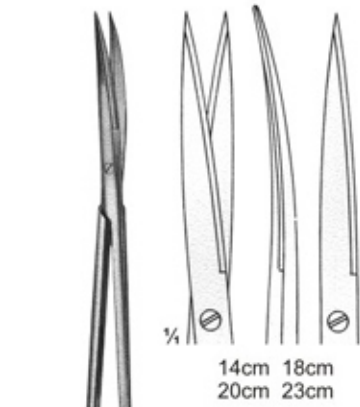

1/2
26-119
Metzenbaum-Fino

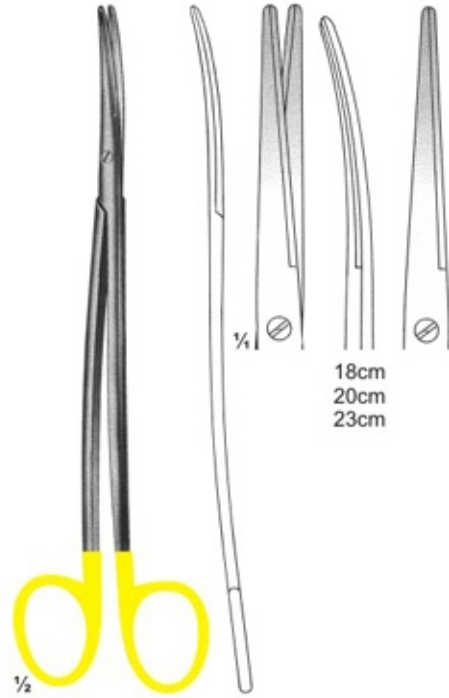

1/2
26-120
Metzenbaum-Fino

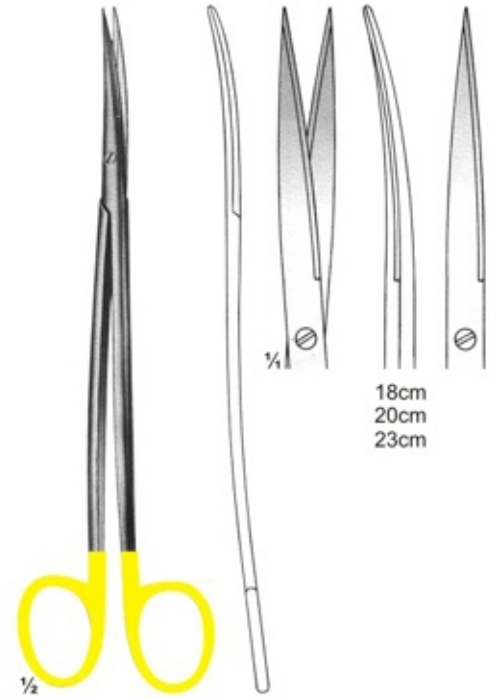

1/2
26-121
Metzenbaum-Fino

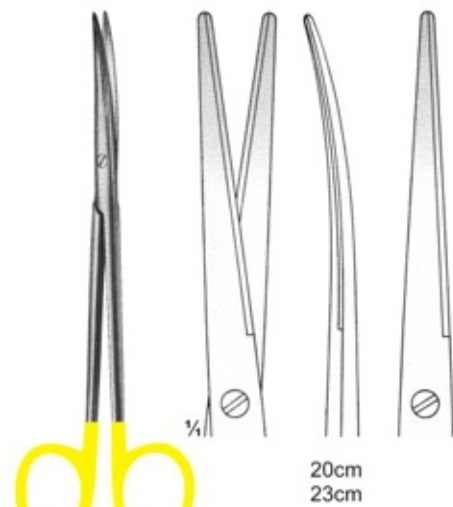

1/2
26-122
Metzenbaum

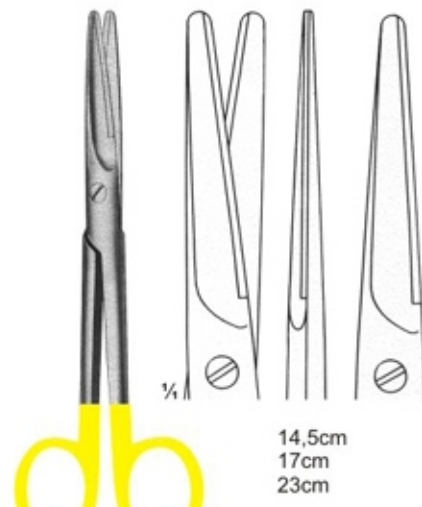

1/2
26-123
Mayo

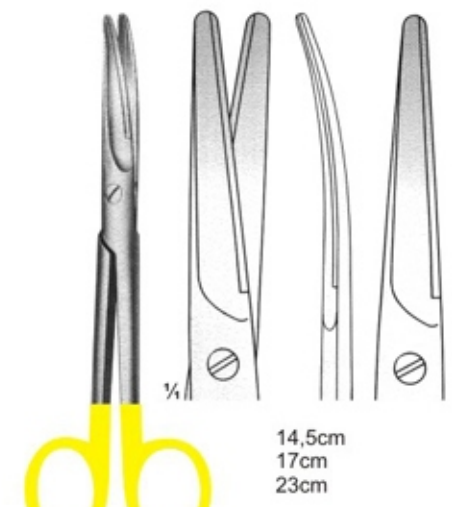

1/2
26-124
Mayo

Scissors with Tungsten Carbide Inserts

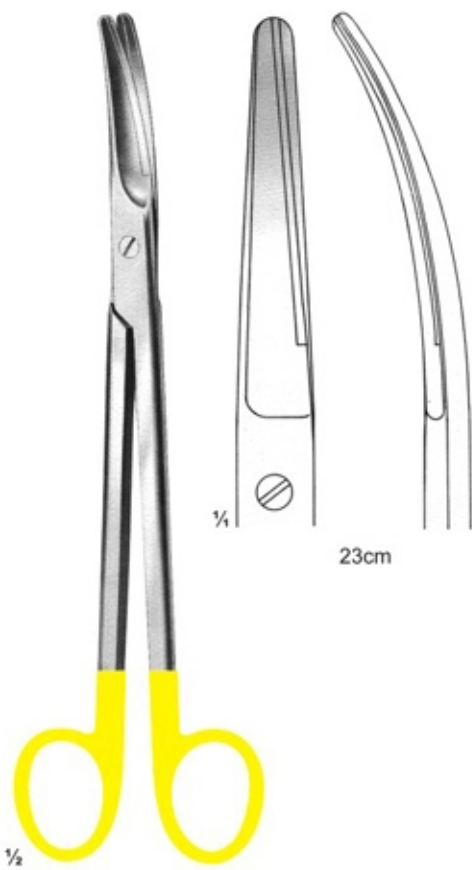

26-125
Parametrium

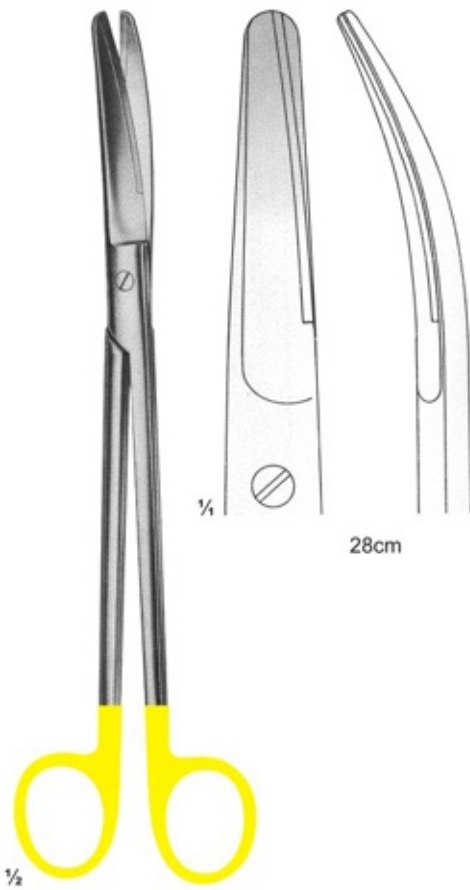

26-126
Mayo-Harrington

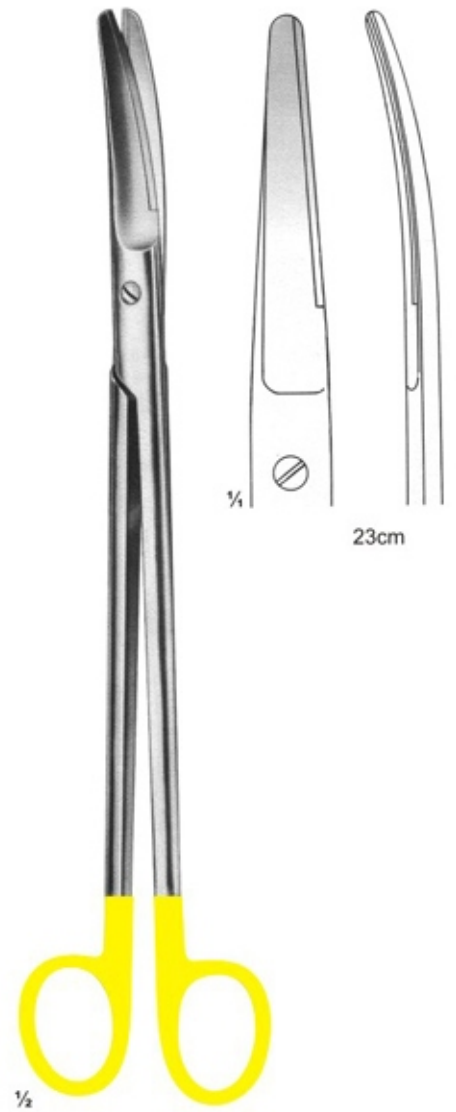

26-127
Sims

Scissors with Tungsten Carbide Inserts

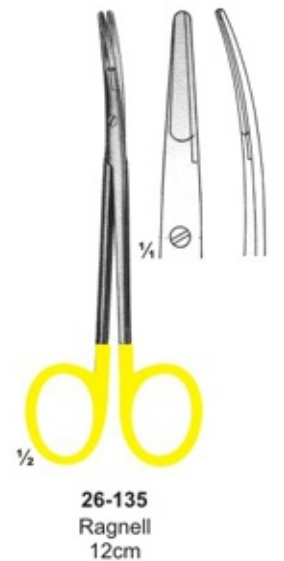
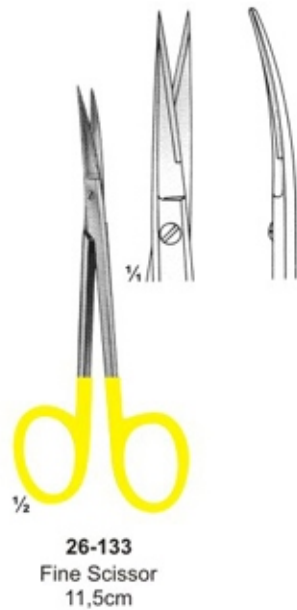
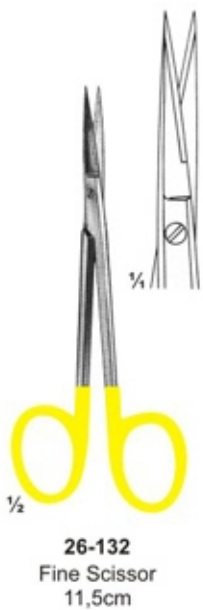
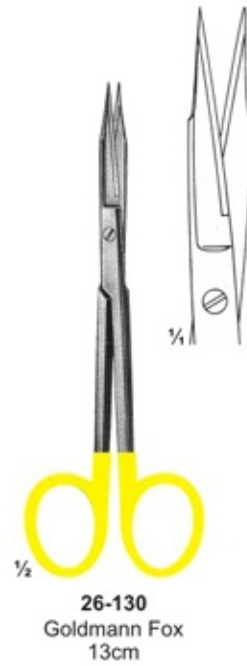
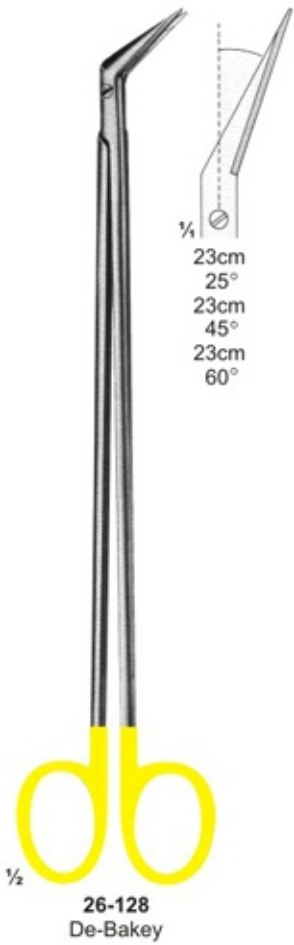

Scissors & Dissecting Forceps with Tungsten Carbide Inserts

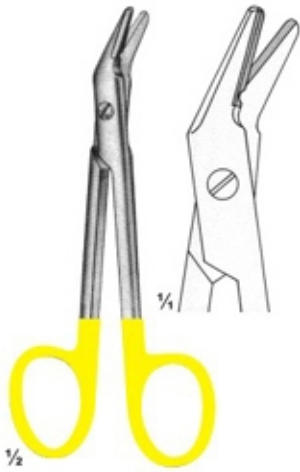

26-136
Universal
12cm



26-137
Ligature Scissors
1 Black & 1 Goldplated ring

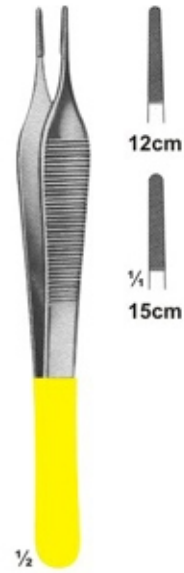

26-138
Adson



26-139
Cushing
17,5cm



26-140
Cushing
18cm



26-141
Cushing-Taylor
18cm



26-142
Dissecting Forceps
15cm



26-143
Semken
15cm

Dissecting Forceps and Needle holders with

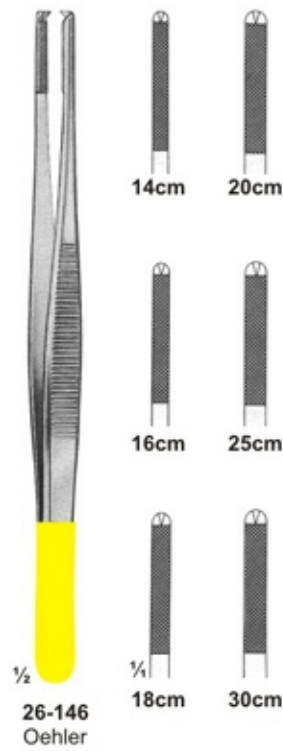
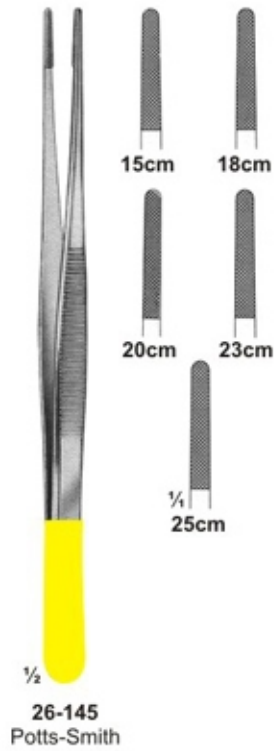
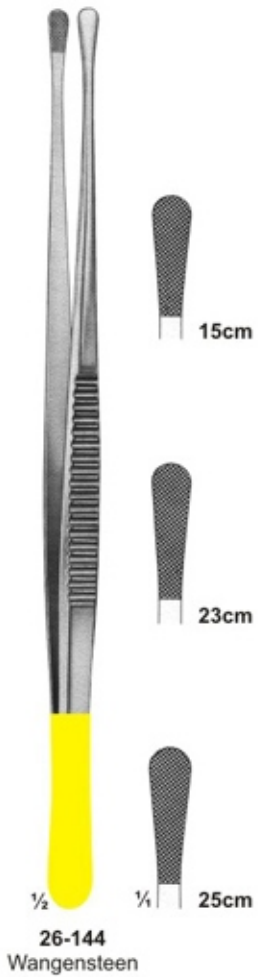

Needle holders with Tungsten Carbide Inserts



26-152
Arruga
16cm



26-153
Castroviejo
13cm

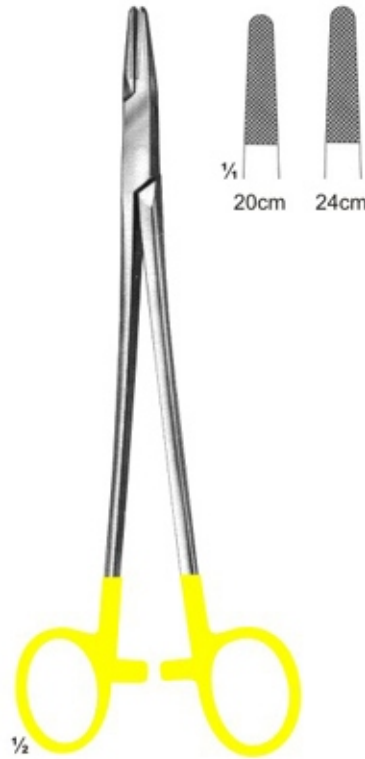

26-154
Hegar
20cm 24cm

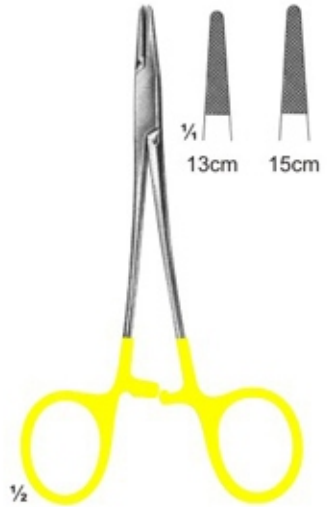

26-155
Halsey
13cm 15cm



26-156
Mayo-Hegar
16cm 18cm 20cm
24cm 26cm 30cm

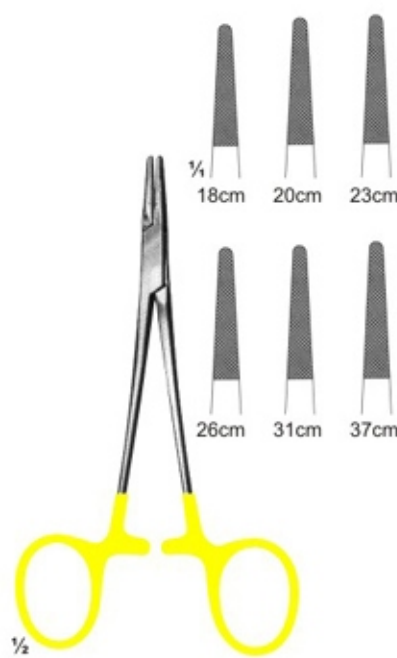

26-157
De-Bakey
18cm 20cm 23cm
26cm 31cm 37cm

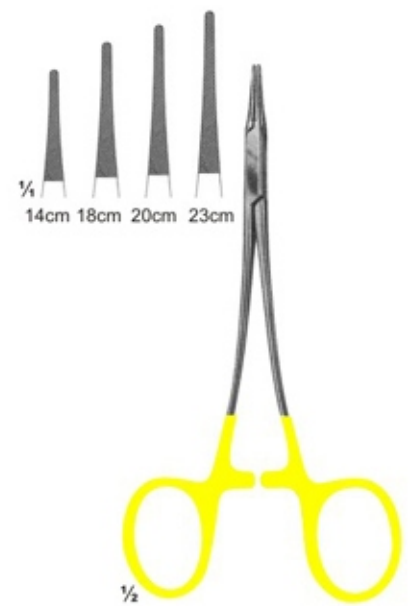

26-158
Hegar-Vascular
14cm 18cm
20cm 23cm

Needle holders with Tungsten Carbide Inserts

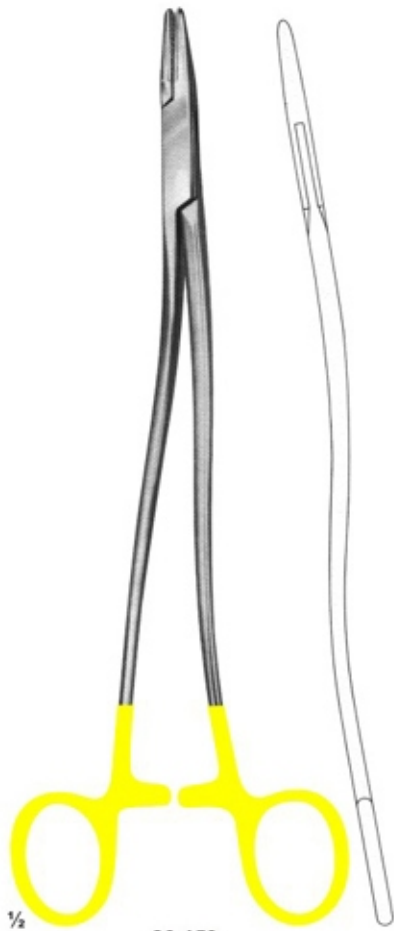

$\frac{1}{2}$
26-159
 Bozemann-Wertheim
 20cm 24cm 26cm



$\frac{1}{2}$
26-160
 Stratte
 22cm 23cm

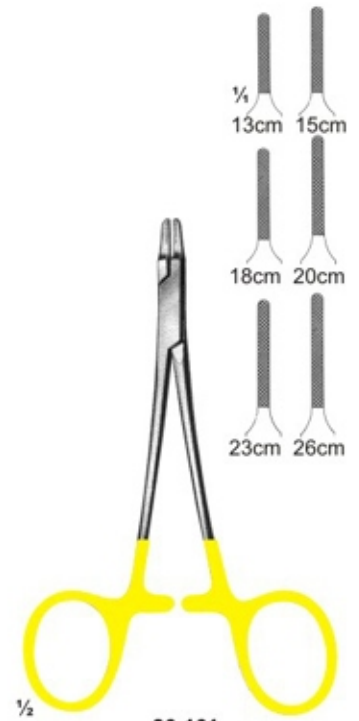

$\frac{1}{2}$
26-161
 Ryder
 13cm 15cm 18cm
 20cm 23cm 26cm



$\frac{1}{2}$
26-162
 Ryder-Vascular
 13cm 15cm 18cm
 20cm 23cm 26cm



$\frac{1}{2}$
26-163
 Martin
 15cm 17cm 20cm



$\frac{1}{2}$
26-164
 Sarot
 18cm 20cm 26cm

Needle holders with Tungsten Carbide Inserts

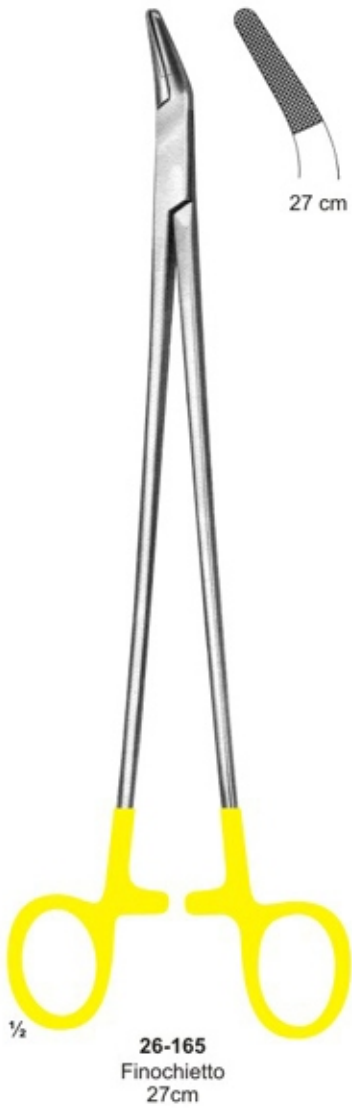

Needle holders with Tungsten Carbide Inserts



26-172
Mathieu-Ryder
17cm
20cm 24cm



26-173
Lichtenberg
20cm



26-174
Langhals
20cm 25cm



26-175
Lichtenberg
20cm 25cm



26-176
Luehty-Beck
20cm 25cm



26-177
Luehty-Beck
20cm 25cm



26-178
Langebeck
18cm
20cm 23cm

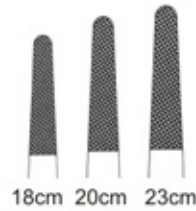

26-179
Langebeck-beck
18cm
20cm 23cm

Wire Cutting Plier With T.C. Inserts



26-180
TOENNIS
 Elastic pattern for
 dura-or intestinal suture
 180 mm



26-181
 Cutting Plier
 12 cm

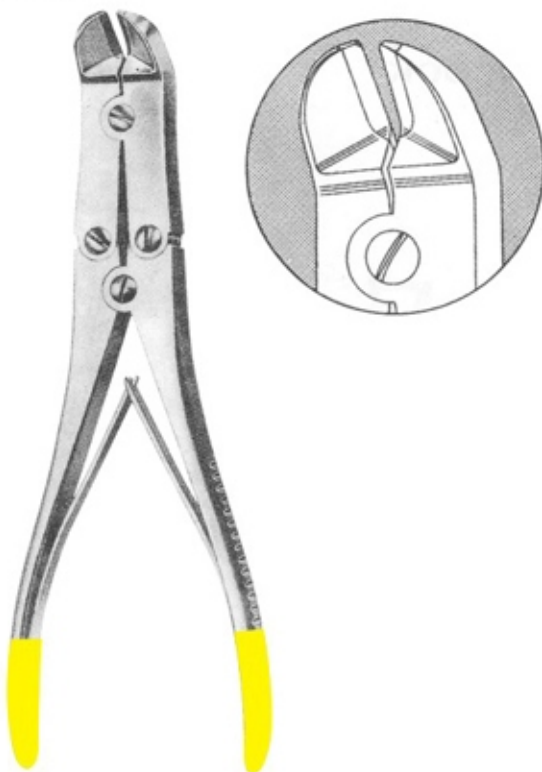

26-182
MULLAR CLAUS
 22 cm



26-183
 Plier
 17.5 cm

Alphabetical Index

A			
ABRAHAM, tonsil knife	13	BRUNS, plaster scissor	64
ADSON, forceps	33	BRYANT, sponge forceps	43
ADSON, forceps	37	BROPHY, Tissue Forceps	38
ALLIS, artery traction forceps	47	BROWN, Tissue Forceps	39
ALLIS, intestinal grasping forceps	86	BUCHS, retractors	75
ALY, aesthesiometer	01	BUCHWALD, tongue depressor	04
AMPUTATING KNIVES	12	BUCK, neurological hammer	01
ANDREW, tongue depressor	04	BUMM, ovum forceps	230
ANESTOPHON, stethoscope	02	BUCK, Ear Curettes	110
ARRUGA, forceps	37		
ARRUGA, needle holder	61	C	
ASCH, biopsy curettes	112	CASPAR, retractor	75
AUFRIEHT, rasps	138	CASPAR, Micro scissor 115mm	16
AYRE, cone knife, 235mm	13	CASTROVIEJO, tissue forceps	37
ADSON - BROWN, Tissue Forceps	39	CASTROVIEJO, micro spring scissor	15
ADSON, Haemostatic Forceps	52	CASTROVIEJO, needle holder	61
ANGLE, Wire Cutters Cutting Scissors	151	CASTROVIEJO, eye scissor 110mm	15
		CASTROVIEJO, eye scissor 115mm	15
B		CATLIN, amputating knife 160mm	12
BABCOCK, intestinal grasping forceps	86	CALIPER, Examination & Measuring Instruments	10
BABY-ALLIS, artery traction forceps	47	CARREL, Haemostatic Forceps	51
BACKHAUS, towel clamps	48	CARROLL, Examination & Measuring Instruments	10
BACKHAUS-KOCHER, towel clamps	48	CASPAR, Rongeurs	133
BAILEY, rib spreaders	128	CASPAR, Rongeurs	134
BAKES, gall duct dilators	95	CASTROVIEJO, Examination & Measuring Instruments	10
BALFOUR, abdominal retractors	85	CHAPUT, artery traction forceps	47
BALFOUR-BABY, abdominal retractors	84	CLOWARD, lamina Spreaders	83
BANE-HARTMANN, bone rongeurs	144	CLAUS PLIER, Wire Cutting Plier With T.C. Inserts	187
BARTH, bone curettes	139	CLAUS PLIER, Wire Cutting Plier With T.C. Inserts	187
BABY-MOSQUITO, Haemostatic Forceps	51	COAKLEY, antrum trocars	100
BABY-ROUX, Retractors	73	COLLIN, intestinal grasping forceps	86
BABY-SENN-MILLER, Retractors	73	COLLIN, rib shears	126
BEEBE wire scissor	29	COLLIN, sponge and dressing forceps	44
BEER, cilia forceps	42	COLLIN, tongue forceps	05
BENGOLEA, delicate forceps	50	COLLIN, vaginal spatula	101
BERGER, biopsy forceps	115	CONE KNIFE 235mm11	13
BERLINER, percussion hammer	01	CONVERSE, fine wound retractor	69
BENDING PLIERS, Wire Holding forceps	150	COOLEY, multi purpose clamps	122
BERTILLON, Examination & Measuring Instruments	10	COTTLE, retractors	71
BIEMER, vein scissor	16	COTTLE, nasal scissor	25
BISHOP-HARMON, forceps	37	COTTLE, fine wound retractor	69
BIEMER, Suction Instruments	158	COTTLE, mallets	140
BLAKE, gall stone forceps	96	COLLIN, Examination & Measuring Instruments	10
BLUMENTHAL, bone rongeurs	144	COLLIN, Intestinal Grasping Forceps	46
BONNEY, tissue forceps	41	COLLIN, Retractors	73
BOSE, tracheal hooks	119	COLLIN-HARTMANN, Retractors	73
BOWLES, stethoscope	02	COTTLE, Forceps, Bayonet – Shaped	40
BOYS-ALLIS, artery traction forceps	47	COTTLE, Nasal Specula	91
BOZEMANN, dressing forceps	108	CRILE, Haemostatic Forceps	52
BOYNTON, Needle Holders	47	CRILE, Haemostatic Forceps	52
BRAUN, artery traction forceps	107	CRILE, Retractors	73
BRAUN, uterine probes	28	CUTTING PLIER, Wire Cutting Plier With T.C. Inserts	187
BRAUN-STADLER episiotomy scissor	31	CRAFOORD, haemostatic forceps	50
BRAUN-STADLER, bandage scissors	102	CRILE, needle holder	63
BRIESKY, vaginal specula	66	CUSCO, vaginal specula	101
BRODIE, probes	34	CUSHING, wound and vein retractor	71
BROPHY, dissecting forceps	04	CUSHING, dissecting forceps	34
BRUENINGS, tongue depressor	13	CUSHING-KOCHER, retractors	71
BRUNINGS, tonsil knife, 215mm	76	CZERNY, gall stone forceps	96
BRUNNER, retractors	126	CZERNY, retractors	72
BRUNNER, rib shears	31		

Alphabetical Index

D		F	
DAVIDSON, scapula retractors	77	FARABEUF, Retractors	73
DAVIS, vascular spatulas	120	FEILCHENELD, splinter forceps	42
DANDY, Haemostatic Forceps	51	FERGUSSON, haemorrhoidal forceps	93
DE BAKEY, forceps	36	FERGUSSON, suction instrument	163
DE BAKEY, anastomosis clamps	89	FERGUSSON-ACKLAND, mouth gag	05
DE BAKEY, anastomosis clamps	125	FINOCHIETTO, forceps	58
DE BAKEY, arteriotomy scissor	22	FINOCHIETTO, rib spreader	127
DE BAKEY, vana cava clamps	123	FINSEN, tracheal hooks	119
DE BAKEY, multi purpose clamps	122	FIBER OPTIC, laryngoscopes	09
DE BAKEY, retractors	82	FINGER NAIL DRIL, Finger Nail Instruments	155
DE BAKEY, atraumata	121	FINGER RING SAW, Finger Nail Instruments	155
DEAN, nasal and tonsil scissor	25	FINSTERER, Suction Instruments	161
DEAVER, retractors	77	FLAT-NOSED PLIERS, Wire Holding forceps	150
DEAVER, surgical scissor (flat lock)	21	FOERSTER-BALLENGER, Tissue Grasping Forceps	45
DE-BAKEY, bulldog clamps	49	FORCEPS, Finger Nail Instruments	155
DEJERINE, percussion hammer	01	FOREGGER, laryngoscopes	09
DELICATE DISSECTING FORCEPS	33	FOMON, nasal scissor	19
DELICATE SCISSORS, blunt points	19	FORD-BOWLES, stethoscope	02
DELICATE SCISSORS, sharp points	18	FOWLER, tonsil knife	13
DELICATE SCISSORS, sharp points	19	FRANCKE, blood lancet	06
DENHARDT, mouth gag	05	FRAZIER, fine wound retractor	69
DENIS-BROWENE, intestinal forceps	41	FRAZIER, suction instruments	163
DERRA, multi purpose clamps	122	FREER, fine wound retractor	69
DESCHAMPS, ligature needles	65	FREER, vascular spatulas	120
DESJARDINS, gall duct forceps	95	FRENZEL, tongue depressor	04
DESJARDINS, gall stone forceps	96	FRICKE, haemostatic forceps	56
DESJARDINS, gall stone scoops	95	FRITSCH, retractor	79
DESMARRES, wound and vein retractors	71	G	
DEMEL, Cerclage Instruments	148	GALLAHER, rasp	126
DIAGNOSTIC SETS	07	GELPI, special retractors	82
DICK, vaginal clamps and compression forceps	59	GELPI, vaginal retractors	105
DIEFFEBACH, bulldog clamps	49	GERALD, dissecting forceps	34
DINGMANN, bone holding forceps	142	GIERTZ-STILLE, rib shears	126
DISSECTING KNIVES	11	GILL, tissue forceps	37
Dissection Instruments	164	GILL-HESS, tissue forceps	37
Dissection Instruments	165	GILLIES, fine wound retractor	69
Dissection Instruments	166	GILLIES, needle holder	63
DITTEL, metal bougies	80	GLOVER, bulldog clamp	49
DOYEN, abdominal retractors	79	GLUCK, rib shears	126
DOYEN, intestinal clamps	87	GOOD, tonsil scissors	25
DOYEN, ovum forceps	230	GORNEY, suction instruments	163
DOYEN, probes	66	GOSSET, abdominal retractors	84
DOYEN, towel clamps	48	GRAEFE, fine wound retractor	69
DOYEN, vaginal specula	104	GRAVE, vaginal specula	102
DUROGRIP, Wire Holding forceps	149	GROSS, dressing forceps	43
DUROTIP, Cutting Pliers	152	GUEDEL-NEGUS, laryngoscope	08
DUROTIP, Cutting Pliers	153	GUTHRIE, fine wound retractor	69
DUROTIP, Wire Cutters Cutting Scissors	151	GUYON, kidney clamps	97
DUVAL-COLLIN, Intestinal Grasping Forceps	46	GERALD, Tissue Forceps	38
DUPLAY, sponge and dressing forceps	43	GILLIES, Tissue Forceps	38
DUVAL, intestinal forceps	41	GOLDSMITH, Nasal Specula	91
E		GRAEFE, Tissue Forceps	39
EISELSBERD, needle holder	63	GRAEFE, Tissue Forceps	39
ELSCHING, forceps	37	GRUENWALD, Forceps, Bayonet – Shaped	40
ENGL.MOD, towel clamps	48	H	
EPPENDORF, biopsy forceps	115	HALLE, vascular spatulas	120
ESMARCH, cloth and plaster scissors	31	HALSTED-MOSQUITO, haemostatic forceps	50
EISELSBERG-MATHIEU, Needle Holders	64	HARTMANN, intestinal clamps	87
EXTRACTION PLIERS, Wire Holding forceps	150		

Alphabetical Index

HARVEY, plate scissors	29	KELLY, tissue grasping forceps	44
HAJEK-KOFLER, Punches	130	KERN-LANE, bone holding forceps	143
HALSTED, Haemostatic Forceps	52	KERRISON-JACOBY, punches	129
HALSTED-MOSQUITO, Haemostatic Forceps	51	KERSTING, anastomosis forceps	89
HARTMANN, Ear Polypus Forceps	112	KELLY, Haemostatic Forceps	51
HARTMANN-HALLE, Nasal Specula	91	KERRISON, Punches	130
HARTMANN-HERZFELR, Ear Polypus Forceps	112	KILLIAN, bone shear	26
HARTMANN-HOFFMAR, Ear Polypus Forceps	112	KILLIAN, rectal spatula	90
HARTMANN-WULLSTEIN, Ear Polypus Forceps	112	KILNER, fine dissecting scissors	22
HARVEY, Wire Cutters Cutting Scissors	151	KILNER, fine wound retractor	69
HEANEY, needle holder	62	KILNER, dissecting scissor	22
HEGAR, needle holder	62	KILLIAN, Nasal Specula	90
HEGAR-OLSEN, needle holder	63	KIRSCHNER, Cutting Pliers	154
HEGER, uterine dilators	106	KIRSCHNER, Wire Extension	147
HEISS, haemostatic forceps	50	KOCHER, Haemostatic Forceps	52
HEISS, dressing forceps	58	KOCHER, Haemostatic Forceps	54
HEISTER, mouth gag	05	KOCHER-OCHSNER, Haemostatic Forceps	55
HENING, plaster spreader	157	KLIMA ROSEGGER, trocars	100
HERGET, biopsy forceps	113	KOCHER, retractor	71
HERTZLER, abdominal retractors	84	KOCHER, bladder retractors	99
HERTZLER, rib spreaders	127	KOCHER, bone retractor	74
HESS, tissue forceps	37	KOCHER, retractors	75
HEYMANN-KNIGHT, scissors	25	KOLLE, blood lancet	06
HEYWOOD-SMITH, ovum forceps	109	KONIG, elevators	135
HEYWOOD-SMITH, sponge holding forceps	44	KONIG, raspatories	137
HEYWOOD-SMITH, tongue forceps	05	KONISATION SMESSER, retractors	57
HOLLOW NEEDLE, Suction Instruments	159	KRAUSE, biopsy tip	115
HOUSE, Suction Instruments	161	KRISTELLER, vaginal specula	102
HUBER, biopsy forceps	115	KRISTELLER, vaginal specula	103
HUNT, tumor & vessel forceps	32	KRONECKER, suture instruments	65
HUNTER, splinter forceps	42	KRONLEIN, haemostatic forceps	56
		KUMMEL, intestinal spatula	80
I		L	
INGE, lamina spreaders	83	LABORDE, tracheal dilators	119
INTEROSSEOUS, cartilage knife	12	LAHEY, artery traction forceps	47
IVES-FANSLER, anoscopies	92	LAHEY, gall duct forceps	94
J		LANE TRETOWAN, bone levers	136
JACKSON BURROWS, retractors	82	LANE, bone holding forceps	143
JACOBSON, bone curettes	139	LANE, bone levers	136
JACOBSON, needle holder	61	LANE, tissue forceps	41
JAEGAR, fine wound retractor	69	LANE, towel clamps	48
JAMESON, dissecting scissor	22	LANGE-HOHMANN, bone levers	136
JAMESON, needle holder	62	LANGENBACK, bone levers	135
JANSEN, bone curettes	139	LANGENBECK, with triangle handle	70
JANSEN, bone rongeurs	144	LANGENBECK, flap knife	12
JOHNS-HOPKING, bulldog clamps	49	LARYNGEAL MIRRORS	06
JOLL (FRIEDMAN), retractors	82	LAWRENCE, ligature forceps	58
JOLL, vaginal retractors	105	LANDOLT, Suction Instruments	160
JONES, towel clamps	48	LANDOLT, Suction Instruments	161
JOSEPH, bone file	138	LANGENBECK, Ear Curettes	110
JOSEPH, dura and skin retractor	69	LEBSCHKE, rib shears	126
JOSEPH, raspatories	137	LEGUEU, bladder retractors	99
JUDD-MASSON, bladder retractors	99	LEKSELL-STILLE, bone rongeurs	145
JANSEN, FORCEPS, Bayonet – Shaped	40	LERICHE, intestinal spatula	80
K		LEWIS, bone file	138
KADER, intestinal spatula	80	LISTER, bandage scissor	30
KALT, needle holder	61	LISTER, cloth scissor	30
KELLY, ovum forceps	109	LISTER, sponge forceps	43
KELLY, anoscopies	92	LISTON, bone cutting forceps	146

Alphabetical Index

LOCKHART-MUMMERY, probes	66	MULLER, dura and skin retractor	69
LOCKWOOD, Intestinal Grasping Forceps	46	MURPHY, head band	03
LUCAE, FORCEPS, Bayonet – Shaped	40	MUSEUX, tissue grasping forceps	47
LUER, Retractors	73	N	
LOCKLIN, delicate scissor	25	NASAL SCISSORS	25
LOPEZ-REINKE, suction instruments	163	NAUJOKS wire scissors	29
LOWER, gall duct forceps	94	NAIL SPLITTING, Finger Nail Instruments	155
LOWMAN, bone clamps	143	NEEDLE HOLDER, for micro surgery	48
LOWMAN-GERSTER, bone clamps	143	NEGUS, tonsil forceps	57
LOWMAN-HOGLUND, bone clamps	143	NELATON, probes	66
LUCAS, gouges	141	NELSON, lung dissecting forceps	41
LUER-KORTE, gall stone scoops	80	NISSEN, gall duct forceps	94
LURE, bone rongeurs	144	NOTO, ovum forceps	109
M		NOTO, sponge holding forceps	44
MAGILL, laryngoscope	07	NOVAK-SCHOECKAERT, biopsy curettes	111
MALTZ, rasps	138	NOYES, micro spring scissor	15
MANNERFELT, osteotomes	141	O	
MANNERFELT, retractors	70	OLIVECRONA, dura scissors	24
MARTIN, uterine probes	107	OLIVECRONA, trigeminal knife	13
MARTINI, bone curettes	139	OTOSCOPE SETS	07
MASING, retractors	71	OTOSCOPE, Diagnostic Sets	07
MASSON, needle holder	62	P	
MASSON-LUETHY, needle holder	62	PARTSCH, raspatories	137
MATHIEU, retractors	72	PARTSCH, gouges	141
MAYO, dissecting scissors	23	PARTSCH, raspatories	137
MAYO, uterine probes	107	PAYR, pylorus clamps	86
MAYO-HARRINGTON, dissecting scissors	23	PEAN, haemostatic forceps	57
MAYO-NOBLE, dissecting scissors	23	PEAN, haemostatic forceps	51
MAYO-STILLE, dissecting scissors	23	PEAN, kidney clamps	97
MARTIN, Nasal Specula	90	PEDERSON, vaginal specula	102
MATHIEU, Needle Holders	64	PEET, splinter forceps	42
MATHIEU-STILLE, Needle Holders	64	PELKMANN, uterine dressing forceps	108
MC INDOE, forceps	34	PERKINS, self retaining retractors	81
MC KENTY, raspatories	137	PIERCE, trocars	100
MEAD, mallets	140	PINARD, wooden stethoscope	02
MC INDOE, Tissue Forceps	38	PLESTER, retractors	81
MCINTOSH, laryngoscopes	09	PLESTER, suction instruments	163
MEDIUM, Dissecting Forceps	35	POOL, suction instruments	162
MICRO-HALSTED, Haemostatic Forceps	51	POTTS-SMITH, cardiovascular scissor	24
MILLIN, Needle Holders	64	PROBES	67
MICHEL, laryngeal mirrors	06	PARKER, Retractors	73
MICRO SCISSORS, laterally angled	17	PEAN, Haemostatic Forceps	52
MICRO-ADSON, forceps	33	PEAN, Haemostatic Forceps	53
MICRO-ADSON, forceps	37	PEAN, Haemostatic Forceps	54
MIDDELDORPF, retractors	75	PENNINGTON, Tissue Grasping Forceps	45
MIKULICZ, tissue forceps	57	PROVIDENCE-HOSPITAL, Haemostatic Forceps	51
MIKULICZ, intestinal spatula	80	Q	
MIKULICZ, retractors	78	QUERVAIN, bone levers	113
MILLER, laryngoscope	08	R	
MILLIN, bladder retractors	99	RABINER, neurological hammer	01
MIXTER, ligature forceps	58	RANDALL, biopsy curettes	111
MOD.USA, plaster spreader	127	RANDALL, kidney stone forceps	98
MORRIS, anastomosis clamps	89	RECAMIER, uterine scoops	116
MOYNIHAN, haemostatic forceps	57	REYNOLDS, dissecting scissors	22
MOYO-HEGAR, needle holder	62	RICHTER, vaginal retractors	105
MOD. WIEN, Nasal Specula	91	ROCHESTER-CARMALT, haemostatic forceps	57
MOLTGEN, Examination & Measuring Instruments	10	ROEDER, towel clamps	48
MULLAR, Wire Cutting Plier With T.C. Inserts	187		
MULLER LIGATURE FORCEPS	49		
MULLER VESSEL CLIPS	49		

Alphabetical Index

ROUX, retractors	72
RUDD, haemorrhoidal ligator	93
RUMEL, dissecting forceps	58
RUSS-MODELL, tissue forceps	41
ROHRSCHEIDER, needle holder	61
ROLLET, dura and skin retractor	69
ROSER KONIG, mouth gag	05
RAMPLEY, Tissue Grasping Forceps	45
RANKIN, Haemostatic Forceps	52
REILL, Cutting Pliers	152
REPLACEMENT LAMP, laryngoscopes	09
ROCHESTER-OCHSNER, Haemostatic Forceps	54
ROCHESTER-PEAN, Haemostatic Forceps	53
ROSE, Retractors	73
ROUND PLIERS, Wire Holding forceps	150

S

SAENGER, ovum forceps	118
SAMII, tumor grasping forceps	32
SATINSKY, vena cava scissors	24
SAUPE, cilia forceps	42
SCALPEL HANDLES	14
SCHAAF, cilia forceps	42
SCHAEDEL, towel clamps	48
SCHEINMANN, biopsy forceps	115
SCHIMMELBUSCH, ether mask	05
SCHMID, vascular spatulas	120
SCHOEMAKER-LOTH, needle holder	63
SCHOENBORN, retractors	71
SCHRODER, uterine scoops	116
SCHUMACHER, rib shears	126
SCHUMACHER, umbilical scissors	28
SCHUMASHER, biopsy forceps	114
SCOVILLE-RICHTER, retractors	67
SEGOND, myomatome	13
SEIDL, vaginal specula	102
SEIDL-DBP, biopsy forceps	114
SELLORS, rib spreaders	128
SEMKEN, dissecting forceps	34
SEMKEN, tissue forceps	37
SENN-MILLER, Retractors	73
SEUTIN, plaster scissor	31
SHAPLEIGH, Ear Curettes	110
SIMON, uterine scoops	116
SIMPLEX, tongue depressor	04
SIMPSON, uterine probes	107
SIMPSON-BRAUN, obstetrics forceps	117
SIMS, gynaecology scissors	27
SIMS, vaginal specula	102
SIMS, rectal specula	90
SIMS, uterine probes	107
SMOOTH JAWS FORCEPS	34
ST.MARTIN, tissue forceps	37
STEMBERG, tongue depressor	04
STIEGLITZ, splinter forceps	42
STILLE, bone rongeurs	145
STILLE-AESULAP, plaster shears	156
STILLE-RUSKIN, bone rongeurs	145
STRACK, wire scissor	29
STRASSBURGER Tissue forceps	41
STANDARD, Dissecting Forceps	35
STANDARD, Tissue Forceps	39

STERBERG, Retractors	
STRULLY, cardiovascular scissors (pointed)	24
SUCTION INSTRUMENTS	162
SURGICAL SCISSORS, incision	21
SURGICAL SCISSORS, serrated	20
SURGICAL SCISSORS, slender type	20
SURGICAL SCISSORS, standard	20
SURGICAL SCISSORS, standard	20
SUTURING INSTRUMENT SET	68
SYSTRUNK, nail splitting scissors	21
SPENCER-WELLS, Haemostatic Forceps	
SYSTRUNK, Finger Nail Instruments	

T

TAKAHASHI, rongeur	112
TAYLOR, percussion hammer	01
TAKAHASHI, Rongeurs	132
THOREK, cardiovascular scissors	24
THORPE, corneal forceps	33
TIECK-HALLE, Nasal Specula	90
TOENNIS, Wire Cutting Plier With T.C. Inserts	187
TOWNLEY, Examination & Measuring Instruments	10
TOBOLD, tongue depressors	04
TOENNIS ADSON, dissecting scissors	22
TOENNIS, dissecting scissors	22
TOENNIS, fine wound retractor	69
TOENNIS, vascular spatulas	120
TOENNIS, needle holder	63
TRELAT, raspatories	137
TRIGEMINAL KNIFE	13
TROCARS	100
TROEMNER, percussion hammer	01
TROUSSEAU, tracheal dilators	119
TROCAR, Suction Instruments	159
TROELTSCH, FORCEPS, Bayonet – Shaped	40
TUFFIER, rib spreaders	127
TUTTLE, lung dissecting forceps	41

U

UMBILICAL CORD SCISSORS	28
UNIVERSAL BANDAGE SCISSORS	30
UNIVERSAL TROCARS	100
US-ARMY, retractors	72

V

VANNAS, micro spring scissors	15
VERNIER, Examination & Measuring Instruments	10
WISE GRIP, Wire Holding forceps	150
VOLKMANN, bone curettes	139
VOLKMANN, bone retractors	74

Alphabetical Index

W

WANGENSTEEN, needle holder	62
WARTENMERG, pinwheel	01
WAGNER, Rongeurs	134
WAUGH, Tissue Forceps	38
WEBER, anastomosis clamps	124
WECKER, eye scissors	15
WEIL-BLAKESLEY, rongeurs	112
WEITLANER, self retaining retractors	81
WERTHEIM, gynaecology scissors	27
WERTHEIM, clamps and forceps	59
WERTHEIM-CULLEN, vaginal clamps	60
WIEDER, tongue depressor	04
WEIL-BLAKESLEY, Rongeurs	132
WILLIGER, bone curettes	139
WILLIGER, elevators	135
WILLIGER, raspatories	137
WINTER, ovum forceps	118
WILDE, Forceps, Bayonet – Shaped	40
WOLFF, plaster breakers	157
WULLSTEIN, retractors	81
WULLSTEIN, Suction Instruments	160

Y

YASARGIL, needle holder	61
YASARGIL, tumor grasping forceps	32
YASARGIL-SAMII, tumor grasping forceps	32
YASARGIL, Suction Instruments	160
YASARGIL, Suction Instruments	161
YASRGIL, micro scissors	17
YEOMAN, biopsy forceps	113
YOUNG, tongue forceps	05
YOUNG– HRYNTSCHAK, Needle Holders	64
YOUNG-MILLIN, Needle Holders	64

Z

ZENKER, ligature	58
ZENKER, retractors	77
ZIEGLER, head band	03
ZIEGLER, head mirror	03



Wellcare Surgicals Ltd,
Lervigsveien 16
4014 Stavanger
Norway

by phone: (+47) 48356487
by email: sales@wellcaresurgical.co.uk